



*konusulan  
the spoken kalite...  
quality...*

# T-SİSTEM

**T-SİSTEM DIŞ TORNA KATERLERİ**  
T-SYSTEM EXTERNAL TURNING TOOLHOLDERS  
T-ТИП ДЕРЖАВКИ ДЛЯ НАРУЖНОГО ТОЧЕНИЯ



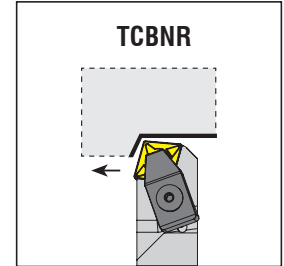
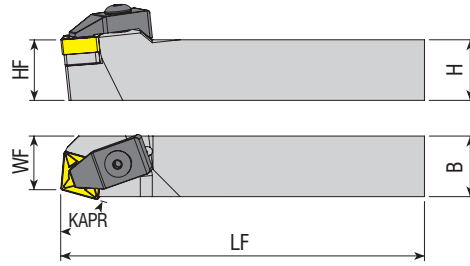

Takım Kodu Ordering Code Код для заказа	Stok Stock Наличие		Takım Ölçüleri (mm) Dimension (mm) Размеры (мм)				Kesici Uç Insert Пластина	Yedek Parçaları / Spare Parts / Запасные части								
	R	L	HF=H	B	LF	WF		Baskı Pabucu Wedge Clamp Прижим	Pabuç Vidası Clamp Screw Зажимной винт	Altlık Shim Опорная пластина	Altlık Vidası Shim Screw Винт опорной пластины	Yay Spring Пружина	Pul Stamp Шайба	Anahtar Allen Key Ключ		
TCBNR/L 2525 M16	●	●	25	25	150	22										

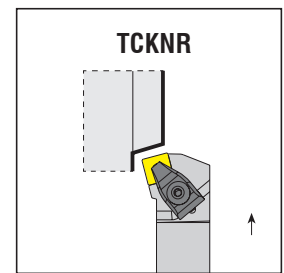
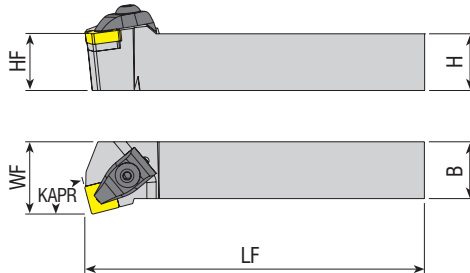

Takım Kodu Ordering Code Код для заказа	Stok Stock Наличие		Takım Ölçüleri (mm) Dimension (mm) Размеры (мм)				Kesici Uç Insert Пластина	Yedek Parçaları / Spare Parts / Запасные части														
	R	L	HF=H	B	LF	WF		Baskı Pabucu Wedge Clamp Прижим	Pabuç Vidası Clamp Screw Зажимной винт	Altlık Shim Опорная пластина	Altlık Vidası Shim Screw Винт опорной пластины	Sekman Ring Кольцо	Pul Stamp Шайба	Anahtar Allen Key Ключ								
TCKNR/L 2020 K12	●	●	20	20	125	25																
2525 M12	●	●	25	25	150	32									CNM. 1204..	ATK-02	AKV-30-M6x22	AACN-3-0001	AAV-02-M5x12	AS-01	ABPL-01	AAL-03-3
3232 P12	●	●	32	32	170	40									CNM. 1606..	ATK-04	AKV-19-M7x25	AACN-3-0002	AAV-05-M6x15	AS-02	ABPL-02	AAL-05-4
2525 M16	●	●	25	25	150	32	3232 P16	●	●	32	32	170	40									

R: Sağ / Right / Правый L: Sol / Left / Левый  
● Stokta / In Stock / В наличии ○ Stokta Yok / Non Stock Item / Нет в наличии

Sipariş Örneği/Ordering Example/Образец заказа  
1 ad./pcs./шт. TCBNR 2525 M16

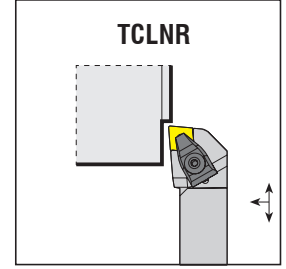
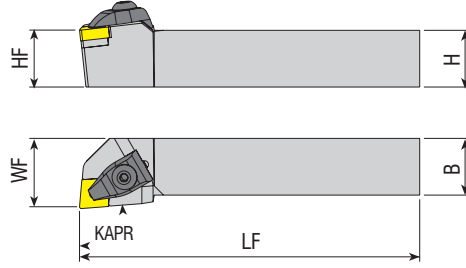

Takım Kodu Ordering Code Код для заказа	Stok Stock Наличие		Takım Ölçüleri (mm) Dimension (mm) Размеры (мм)				Kesici Uç Insert Пластина	Yedek Parçaları / Spare Parts / Запасные части								
	R	L	HF=H	B	LF	WF		Baskı Pabucu Wedge Clamp Прижим	Pabuç Vidası Clamp Screw Зажимной винт	Altlık Shim Опорная пластина	Altlık Vidası Shim Screw Винт опорной пластины	Sekman Ring Кольцо	Pul Stamp Шайба	Anahtar Allen Key Ключ		
<b>TCLNR/L 2020 K12</b>	●	●	20	20	125	25										
<b>2525 M12</b>	●	●	25	25	150	32										
<b>3232 P12</b>	●	●	32	32	170	40										
<b>4040 S12</b>	●	●	40	40	250	50										
<b>5050 S12</b>	●	●	50	50	250	63	<b>CNM. 1204..</b>	ATK-02	AKV-30-M6x22	AACN-3-0001	AAV-02-M5x12	AS-01	ABPL-01	AAL-03-3		
<b>2525 M16</b>	●	●	25	25	150	32										
<b>3232 P16</b>	●	●	32	32	170	40	<b>CNM. 1606..</b>	ATK-04	AKV-19-M7x25	AACN-3-0002	AAV-05-M6x15	AS-02	ABPL-02	AAL-05-4		

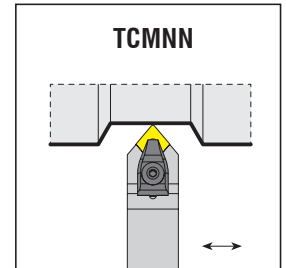
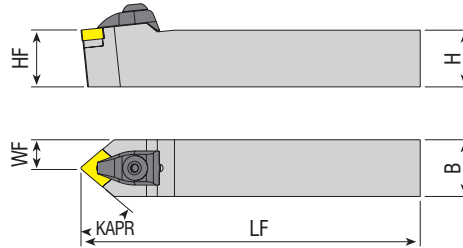

Takım Kodu Ordering Code Код для заказа	Stok Stock Наличие		Takım Ölçüleri (mm) Dimension (mm) Размеры (мм)				Kesici Uç Insert Пластина	Yedek Parçaları / Spare Parts / Запасные части								
	R	L	HF=H	B	LF	WF		Baskı Pabucu Wedge Clamp Прижим	Pabuç Vidası Clamp Screw Зажимной винт	Altlık Shim Опорная пластина	Altlık Vidası Shim Screw Винт опорной пластины	Sekman Ring Кольцо	Pul Stamp Шайба	Anahtar Allen Key Ключ		
<b>TCMNN 1616 H12</b>	●		16	16	100	8										
<b>2020 K12</b>	●		20	20	125	10										
<b>2525 M12</b>	●		25	25	150	12.5										
<b>3232 P12</b>	●		32	32	170	16										
<b>2525 M16</b>	●		25	25	150	12.5	<b>CNM. 1204..</b>	ATK-02	AKV-30-M6x22	AACN-3-0001	AAV-02-M5x12	AS-01	ABPL-01	AAL-03-3		
<b>3232 P16</b>	●		32	32	170	16										
<b>4040 S16</b>	○		40	40	250	20	<b>CNM. 1606..</b>	ATK-04	AKV-19-M7x25	AACN-3-0002	AAV-05-M6x15	AS-02	ABPL-02	AAL-05-4		

R: Sağ / Right / Правый L: Sol / Left / Левый  
● Stokta / In Stock / В наличии ○ Stokta Yok / Non Stock Item / Нет в наличии

Sipariş Örneği/Ordering Example/Образец заказа  
1 ad./pcs./шт. TCLNR 2020 K12

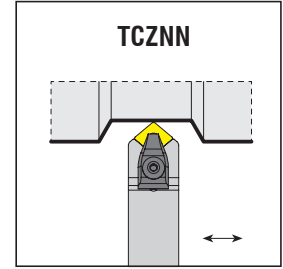
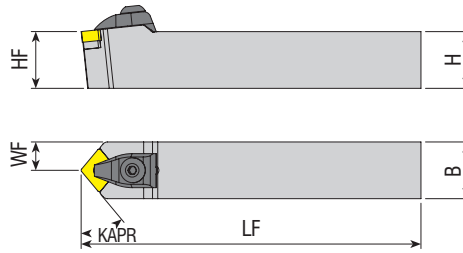
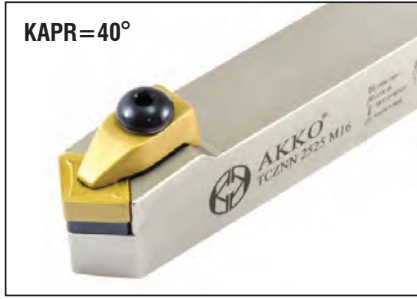

Takım Kodu Ordering Code Код для заказа	Stok Stock Наличие		Takım Ölçüleri (mm) Dimension (mm) Размеры (мм)				Kesici Uç Insert Пластина	Yedek Parçaları / Spare Parts / Запасные части														
	R	L	HF=H	B	LF	WF		Baskı Pabucu Wedge Clamp Прижим	Pabuç Vidası Clamp Screw Зажимной винт	Aitlik Shim Опорная пластина	Aitlik Vidası Shim Screw Винт опорной пластины	Sekman Ring Кольцо	Pul Stamp Шайба	Anahtar Allen Key Ключ								
<b>TCZNN 2020 K12</b>	●		20	20	125	10																
<b>2525 M12</b>	●		25	25	150	12.5									<b>CNM. 1204..</b>	ATK-02	AKV-30-M6x22	AACN-3-0001	AAV-02-M5x12	AS-01	ABPL-01	AAL-03-3
<b>3232 P12</b>	●		32	32	170	16																
<b>2525 M16</b>	●		25	25	150	12.5	<b>CNM. 1606..</b>															
<b>3232 P16</b>	●		32	32	170	16																

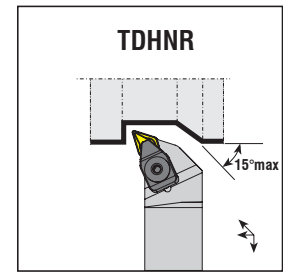
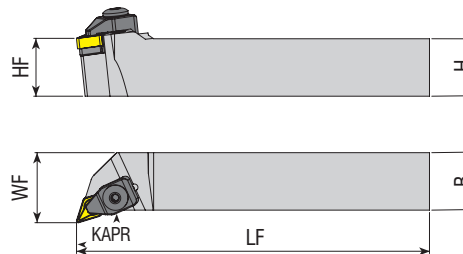

Takım Kodu Ordering Code Код для заказа	Stok Stock Наличие		Takım Ölçüleri (mm) Dimension (mm) Размеры (мм)				Kesici Uç Insert Пластина	Yedek Parçaları / Spare Parts / Запасные части								
	R	L	HF=H	B	LF	WF		Baskı Pabucu Wedge Clamp Прижим	Pabuç Vidası Clamp Screw Зажимной винт	Aitlik Shim Опорная пластина	Aitlik Vidası Shim Screw Винт опорной пластины	Sekman Ring Кольцо	Pul Stamp Шайба	Anahtar Allen Key Ключ		
<b>TDHNR/L 2525 M11</b>	○	●	25	25	150	31										
<b>2020 K15</b>	●	●	20	20	125	25									<b>DNM. 1104..</b>	ATK-01
<b>2525 M15</b>	●	●	25	25	150	32	<b>DNM. 1506..</b>									
<b>3232 P15</b>	●	●	32	32	170	40										

R: Sağ / Right / Правый L: Sol / Left / Левый  
● Stokta / In Stock / В наличии ○ Stokta Yok / Non Stock Item / Нет в наличии

Sipariş Örneği/Ordering Example/Образец заказа  
1 ad./pcs./шт. TCZNN 2020 K12

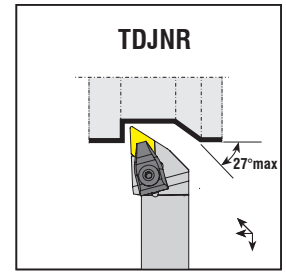
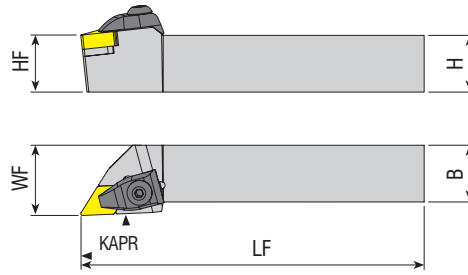

Takım Kodu Ordering Code Код для заказа	Stok Stock Наличие		Takım Ölçüleri (mm) Dimension (mm) Размеры (мм)				Kesici Uç Insert Пластина	Yedek Parçaları / Spare Parts / Запасные части								
	R	L	HF=H	B	LF	WF		Baskı Pabuçu Wedge Clamp Прижим	Pabuç Vidası Clamp Screw Закрепительный винт	Altlık Shim Опорная пластина	Altlık Vidası Shim Screw Винт опорной пластины	Sekman Ring Кольцо	Pul Stamp Шайба	Anahtar Allen Key Ключ		
<b>TDJNR/L 1616 H11</b>	●	●	16	16	100	20	<b>DNM. 1104..</b>									
<b>2020 K11</b>	●	●	20	20	125	25										
<b>2525 M11</b>	●	●	25	25	150	32										
<b>2020 K15</b>	●	●	20	20	125	25	<b>DNM. 1506..</b>									
<b>2525 M15</b>	●	●	25	25	150	32										
<b>3232 P15</b>	●	●	32	32	170	40										
<b>4040 S15</b>	●	●	40	40	250	50										
<b>5050 S15</b>	○	○	50	50	250	63										
<b>2020 K1504</b>	●	●	20	20	125	25	<b>DNM. 1504..</b>									
<b>2525 M1504</b>	●	●	25	25	150	32										
<b>3232 P1504</b>	●	●	32	32	170	40										
<b>4040 S1504</b>	●	●	40	40	250	50										

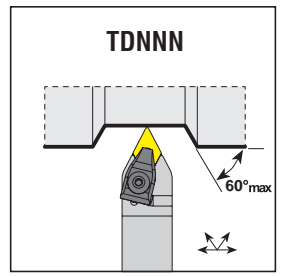
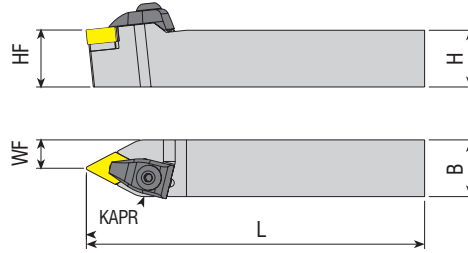

Takım Kodu Ordering Code Код для заказа	Stok Stock Наличие		Takım Ölçüleri (mm) Dimension (mm) Размеры (мм)				Kesici Uç Insert Пластина	Yedek Parçaları / Spare Parts / Запасные части								
	R	L	HF=H	B	LF	WF		Baskı Pabuçu Wedge Clamp Прижим	Pabuç Vidası Clamp Screw Закрепительный винт	Altlık Shim Опорная пластина	Altlık Vidası Shim Screw Винт опорной пластины	Sekman Ring Кольцо	Pul Stamp Шайба	Anahtar Allen Key Ключ		
<b>TDNNN 1616 H11</b>	●	●	16	16	100	8	<b>DNM. 1104..</b>									
<b>2020 K11</b>	●	●	20	20	125	10										
<b>2525 M11</b>	●	●	25	25	150	12.5										
<b>2020 K15</b>	●	●	20	20	125	10	<b>DNM. 1506..</b>									
<b>2525 M15</b>	●	●	25	25	150	12.5										
<b>3232 P15</b>	●	●	32	32	170	16										
<b>4040 S15</b>	○	○	40	40	250	20										
<b>5050 S15</b>	○	○	50	50	250	25										

R: Sağ / Right / Правый L: Sol / Left / Левый

● Stokta / In Stock / В наличии ○ Stokta Yok / Non Stock Item / Нет в наличии

Sipariş Örneği/Ordering Example/Образец заказа

1 ad./pcs./шт. TDJNR 1616 H11

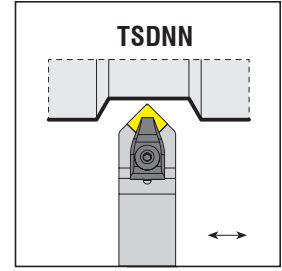
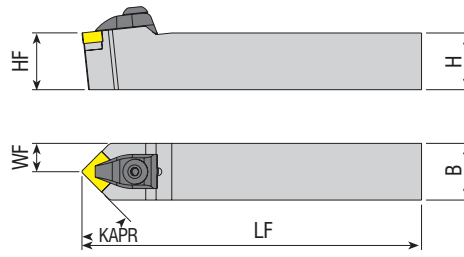

Takım Kodu Ordering Code Код для заказа	Stok Stock Наличие		Takım Ölçüleri (mm) Dimension (mm) Размеры (мм)				Kesici Uç Insert Пластина	Yedek Parçaları / Spare Parts / Запасные части						
	R	L	HF=H	B	LF	WF		Baskı Pabuçu Wedge Clamp Прижим	Pabuç Vidası Clamp Screw Зажимной винт	Altlık Shim Опорная пластина	Altlık Vidası Shim Screw Винт опорной пластины	Sekman Ring Кольцо	Pul Stamp Шайба	Anahtar Allen Key Ключ
<b>TSDNN 1616 H12</b>	●		16	16	100	8	<b>SNM. 1204..</b>							
<b>2020 K12</b>	●		20	20	125	10								
<b>2525 M12</b>	●		25	25	150	12.5								
<b>3232 P12</b>	●		32	32	170	16								
<b>2525 M15</b>	○		25	25	150	12.5	<b>SNM. 1506..</b>							
<b>3232 P15</b>	●		32	32	170	16								
<b>4040 S15</b>	○		40	40	250	20								

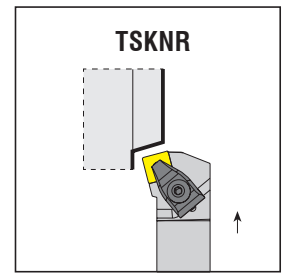
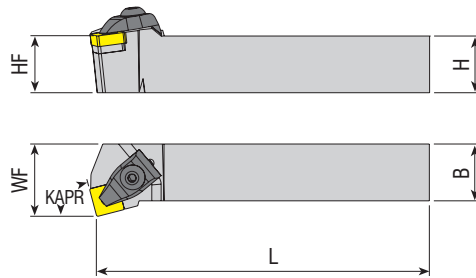

Takım Kodu Ordering Code Код для заказа	Stok Stock Наличие		Takım Ölçüleri (mm) Dimension (mm) Размеры (мм)				Kesici Uç Insert Пластина	Yedek Parçaları / Spare Parts / Запасные части						
	R	L	HF=H	B	LF	WF		Baskı Pabuçu Wedge Clamp Прижим	Pabuç Vidası Clamp Screw Зажимной винт	Altlık Shim Опорная пластина	Altlık Vidası Shim Screw Винт опорной пластины	Sekman Ring Кольцо	Pul Stamp Шайба	Anahtar Allen Key Ключ
<b>TSKNR/L 2020 K12</b>	●	●	20	20	125	25	<b>SNM. 1204..</b>							
<b>2525 M12</b>	●	●	25	25	150	32								
<b>3232 P12</b>	●	●	32	32	170	40								
<b>3232 P15</b>	●	●	32	32	170	40	<b>SNM. 1506..</b>							

R: Sağ / Right / Правый L: Sol / Left / Левый

● Stokta / In Stock / В наличии ○ Stokta Yok / Non Stock Item / Нет в наличии

Sipariş Örneği/Ordering Example/Образец заказа

1 ad./pcs./шт. TSDNN 1616 H12

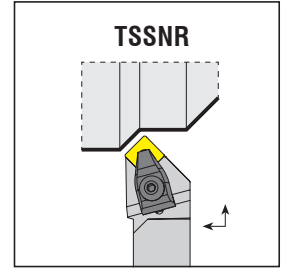
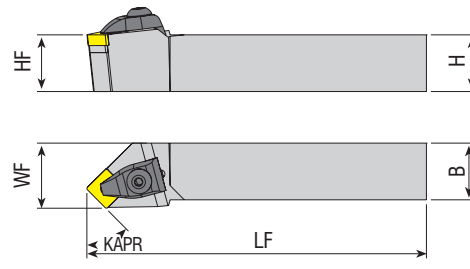

Takım Kodu Ordering Code Код для заказа	Stok Stock Наличие		Takım Ölçüleri (mm) Dimension (mm) Размеры (мм)				Kesici Uç Insert Пластина	Yedek Parçaları / Spare Parts / Запасные части							
	R	L	HF=H	B	LF	WF		Baskı Pabucu Wedge Clamp Прижим	Pabuç Vidası Clamp Screw Зажимной винт	Altlık Shim Опорная пластина	Altlık Vidası Shim Screw Винт опорной пластины	Sekman Ring Кольцо	Pul Stamp Шайба	Anahtar Allen Key Ключ	
<b>TSSNR/L 2020 K12</b>	●	●	20	20	125	25	<b>SNM. 1204..</b>								
<b>2525 M12</b>	●	●	25	25	150	32									
<b>3232 P12</b>	●	●	32	32	170	40									
<b>2525 M15</b>	●	●	25	25	150	32	<b>SNM. 1506..</b>								
<b>3232 P15</b>	●	●	32	32	170	40									

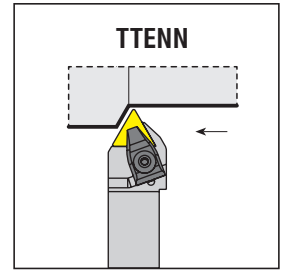
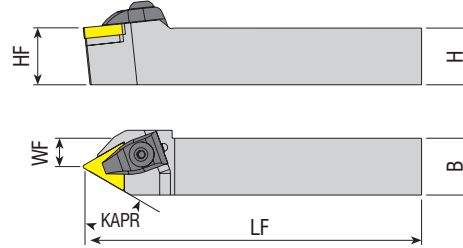

Takım Kodu Ordering Code Код для заказа	Stok Stock Наличие		Takım Ölçüleri (mm) Dimension (mm) Размеры (мм)				Kesici Uç Insert Пластина	Yedek Parçaları / Spare Parts / Запасные части							
			HF=H	B	LF	WF		Baskı Pabucu Wedge Clamp Прижим	Pabuç Vidası Clamp Screw Зажимной винт	Altlık Shim Опорная пластина	Altlık Vidası Shim Screw Винт опорной пластины	Sekman Ring Кольцо	Pul Stamp Шайба	Anahtar Allen Key Ключ	
<b>TTENN 2020 K16</b>	●		20	20	125	10	<b>TNM. 1604..</b>								
<b>2525 M16</b>	●		25	25	150	12.5									
<b>3232 P16</b>	●		32	32	170	16									
<b>2525 M22</b>	●		25	25	150	12.5	<b>TNM. 2204..</b>								
<b>3232 P22</b>	●		32	32	170	16									
<b>4040 S22</b>	○		40	40	250	20									

R: Sağ / Right / Правый L: Sol / Left / Левый

● Stokta / In Stock / В наличии ○ Stokta Yok / Non Stock Item / Нет в наличии

Sipariş Örneği/Ordering Example/Образец заказа  
1 ad./pcs./шт. TSSNR 2020 K12

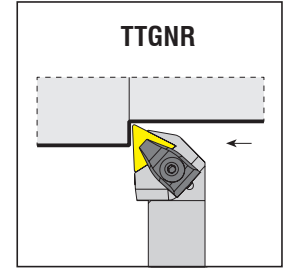
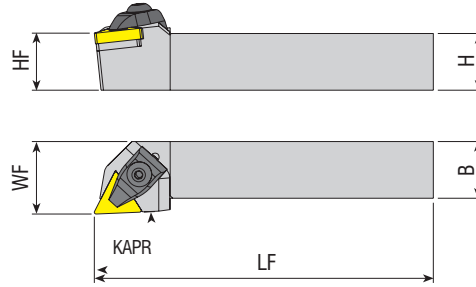
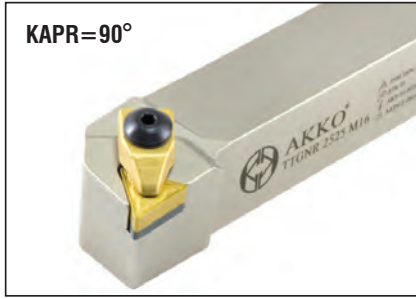

Takım Kodu Ordering Code Код для заказа	Stok Stock Наличие		Takım Ölçüleri (mm) Dimension (mm) Размеры (мм)				Kesici Uç Insert Пластина	Yedek Parçaları / Spare Parts / Запасные части								
	R	L	HF=H	B	LF	WF		Baskı Pabuçu Wedge Clamp Прижим	Pabuç Vidası Clamp Screw Зажимной винт	Altlık Shim Опорная пластина	Altlık Vidası Shim Screw Винт опорной пластины	Sekman Ring Кольцо	Pul Stamp Шайба	Anahtar Allen Key Ключ		
TTGNR/L 2020 K16	●	●	20	20	125	25	TNM. 1604..		AKV-01-M5x22	AATN-2-0002	AAV-03-M5x12	-	ABPL-01	AAL-03-3		
2525 M16	●	●	25	25	150	32										
3232 P16	●	●	32	32	170	40										
2525 M22	●	●	25	25	150	32	TNM. 2204..	ATK-02	AKV-30-M6x22	AATN-3-0015	AAV-02-M5x12	AS-01				
3232 P22	●	●	32	32	170	40										
4040 S22	○	○	40	40	250	50										

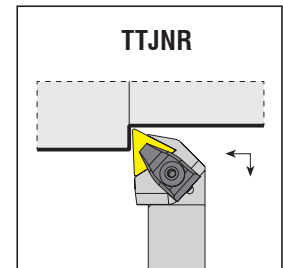
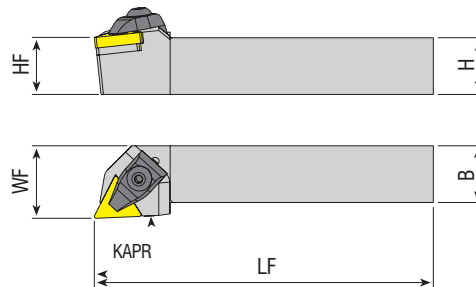
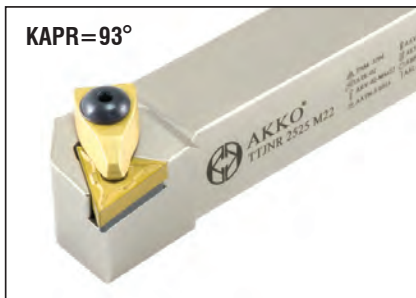

Takım Kodu Ordering Code Код для заказа	Stok Stock Наличие		Takım Ölçüleri (mm) Dimension (mm) Размеры (мм)				Kesici Uç Insert Пластина	Yedek Parçaları / Spare Parts / Запасные части								
	R	L	HF=H	B	LF	WF		Baskı Pabuçu Wedge Clamp Прижим	Pabuç Vidası Clamp Screw Зажимной винт	Altlık Shim Опорная пластина	Altlık Vidası Shim Screw Винт опорной пластины	Sekman Ring Кольцо	Pul Stamp Шайба	Anahtar Allen Key Ключ		
TTJNR/L 2020 K16	●	●	20	20	125	25	TNM. 1604..		AKV-01-M5x22	AATN-2-0002	AAV-03-M5x12	-	ABPL-01	AAL-03-3		
2525 M16	●	●	25	25	150	32										
3232 P16	●	●	32	32	170	40										
2525 M22	●	●	25	25	150	32	TNM. 2204..	ATK-02	AKV-30-M6x22	AATN-3-0015	AAV-02-M5x12	AS-01				
3232 P22	●	●	32	32	170	40										
4040 S22	○	○	40	40	250	50										

R: Sağ / Right / Правый L: Sol / Left / Левый  
● Stokta / In Stock / В наличии ○ Stokta Yok / Non Stock Item / Нет в наличии

Sipariş Örneği/Ordering Example/Образец заказа  
1 ad./pcs./шт. TTGNR 2020 K16



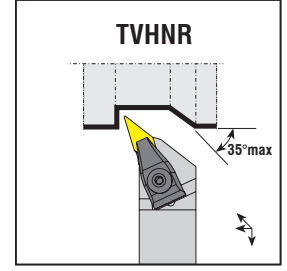
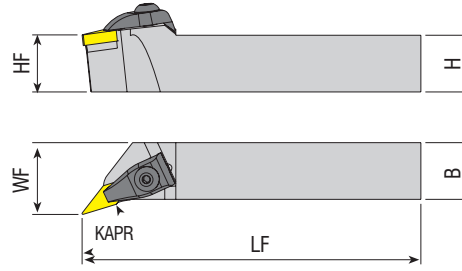

Takım Kodu Ordering Code Код для заказа	Stok Stock Наличие		Takım Ölçüleri (mm) Dimension (mm) Размеры (мм)				Kesici Uç Insert Пластина	Yedek Parçaları / Spare Parts / Запасные части						
	R	L	HF=H	B	LF	WF		Baskı Pabucu Wedge Clamp Прижим	Pabuç Vidası Clamp Screw Зажимной винт	Altlık Shim Опорная пластина	Altlık Vidası Shim Screw Винт опорной пластины	Sekman Ring Кольцо	Pul Stamp Шайба	Anahtar Allen Key Ключ
	●	●												
TVHNR/L 2020 K16	●	●	20	20	125	25	VNM. 1604..	ATK-03	AKV-30-M6x22	AAVN-2-0002	AAV-04-M5x12	AS-01	ABPL-01	AAL-03-3
2525 M16	●	●	25	25	150	32								
3232 P16	●	●	32	32	170	40								

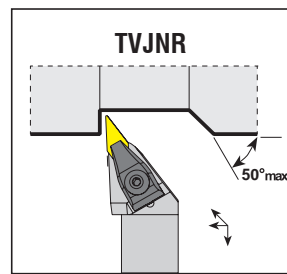
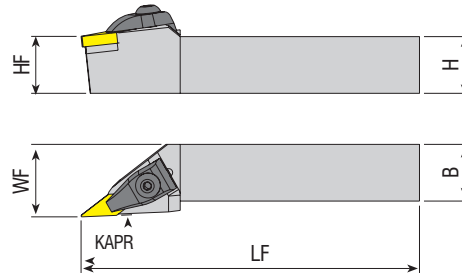

Takım Kodu Ordering Code Код для заказа	Stok Stock Наличие		Takım Ölçüleri (mm) Dimension (mm) Размеры (мм)				Kesici Uç Insert Пластина	Yedek Parçaları / Spare Parts / Запасные части						
	R	L	HF=H	B	LF	WF		Baskı Pabucu Wedge Clamp Прижим	Pabuç Vidası Clamp Screw Зажимной винт	Altlık Shim Опорная пластина	Altlık Vidası Shim Screw Винт опорной пластины	Sekman Ring Кольцо	Pul Stamp Шайба	Anahtar Allen Key Ключ
	●	●												
TVJNR/L 2020 K16	●	●	20	20	125	25	VNM. 1604..	ATK-03	AKV-30-M6x22	AAVN-2-0002	AAV-04-M5x12	AS-01	ABPL-01	AAL-03-3
2525 M16	●	●	25	25	150	32								
3232 P16	●	●	32	32	170	40								

R: Sağ / Right / Правый L: Sol / Left / Левый  
● Stokta / In Stock / В наличии ○ Stokta Yok / Non Stock Item / Нет в наличии

Sipariş Örneği/Ordering Example/Образец заказа  
1 ad./pcs./шт. TVHNR 2020 K16

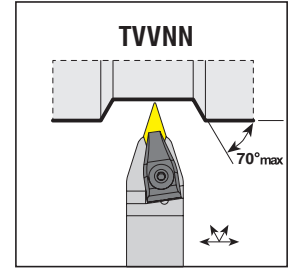
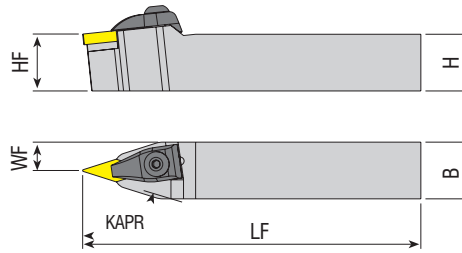

Takım Kodu Ordering Code Код для заказа	Stok Stock Наличие		Takım Ölçüleri (mm) Dimension (mm) Размеры (мм)				Kesici Uç Insert Пластина	Yedek Parçaları / Spare Parts / Запасные части													
	R	L	HF=H	B	LF	WF		Baskı Pabuçu Wedge Clamp Прижим	Pabuç Vidası Clamp Screw Закрепительный винт	Altılık Shim Опорная пластина	Altılık Vidası Shim Screw Винт опорной пластины	Sekman Ring Кольцо	Pul Stamp Шайба	Anahtar Allen Key Ключ							
TVVNN 2020 K16	●		20	20	125	10	VNM. 1604..														
2525 M16	●		25	25	150	12.5									ATK-03	AKV-30-M6x22	AAVN-2-0002	AAV-04-M5x12	AS-01	ABPL-01	AAL-03-3
3232 P16	●		32	32	170	16															

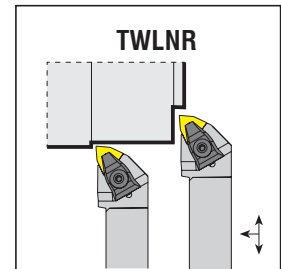
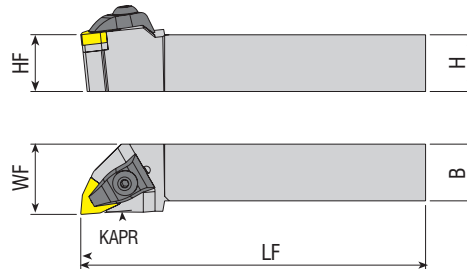

Takım Kodu Ordering Code Код для заказа	Stok Stock Наличие		Takım Ölçüleri (mm) Dimension (mm) Размеры (мм)				Kesici Uç Insert Пластина	Yedek Parçaları / Spare Parts / Запасные части													
	R	L	HF=H	B	LF	WF		Baskı Pabuçu Wedge Clamp Прижим	Pabuç Vidası Clamp Screw Закрепительный винт	Altılık Shim Опорная пластина	Altılık Vidası Shim Screw Винт опорной пластины	Sekman Ring Кольцо	Pul Stamp Шайба	Anahtar Allen Key Ключ							
TWLNR/L 1616 H06	●	●	16	16	100	20	WNM. 0604..														
2020 K06	●	●	20	20	125	25									ATK-01	AKV-01-M5x22	AAWN-SW317	AAV-01-M3x10	-		
2525 M06	●	●	25	25	150	32															
2020 K08	●	●	20	20	125	25	WNM. 0804..														
2525 M08	●	●	25	25	150	32									ATK-02	AKV-30-M6x22	AAWN-3-0001	AAV-02-M5x12	AS-01	ABPL-01	AAL-03-3
3232 P08	●	●	32	32	170	40															
4040 S08	●	●	40	40	250	50															
5050 S08	○	○	50	50	250	63															

R: Sağ / Right / Правый L: Sol / Left / Левый  
● Stokta / In Stock / В наличии ○ Stokta Yok / Non Stock Item / Нет в наличии

Sipariş Örneği/Ordering Example/Образец заказа  
1 ad./pcs./шт. TVVNN 2020 K16



*konusulan  
the spoken kalite...  
quality...*

# T-SİSTEM

**T-SİSTEM İÇTEN SOĞUTMA KANALLI DIŞ TORNA KATERLERİ**  
T-SYSTEM EXTERNAL TURNING TOOLHOLDERS WITH COOLANT HOLE  
T-ТИП ДЕРЖАВКИ ДЛЯ НАРУЖНОГО ТОЧЕНИЕ С ПОДВОДОМ СОЖ



**DETAYLI BİLGİ İÇİN BARKODU OKUTUNUZ**

SCAN ME FOR MORE DETAILS

ПРОСКАНИРУЙТЕ ДЛЯ ПОЛУЧЕНИЯ БОЛЕЕ ПОДРОБНОЙ ИНФОРМАЦИИ



KAPR=95°

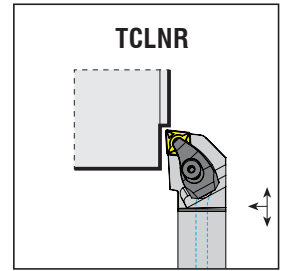
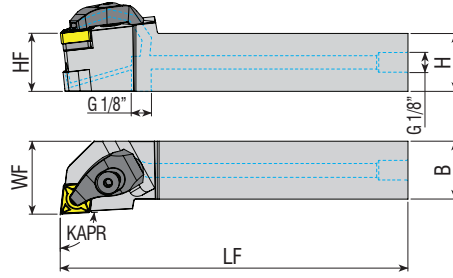
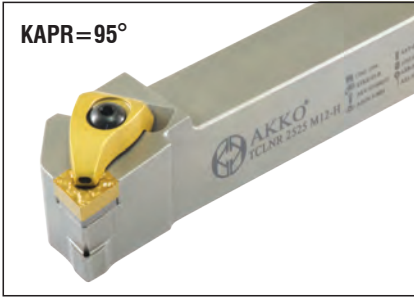

**Takım Kodu**  
**Ordering Code**  
 Код для заказа

Stok Stock Наличие		Takım Ölçüleri (mm) Dimension (mm) Размеры (мм)				
R	L	HF=H	B	LF	WF	

TCLNR/L 2020 K12-H  
 2525 M12-H  
 3232 P12-H

●	●	20	20	125	25
●	●	25	25	150	32
●	●	32	32	170	40

Kesici Uç  
Insert  
Пластина



CNM. 1204..

Baskı Pabucu  
Wedge Clamp  
Прижим



ATKH-01-R  
 ATKH-02-L

Pabuç Vidası  
Clamp Screw  
Закрепной винт



AKV-33-M6x22

Aitlik Shim  
Отпорная пластина



AACN-3-0001

Aitlik Vidası  
Shim Screw  
Винт отпорной пластины



AAV-13-M5x8

Yay  
Spring  
Пружина



AKY-01

Oring  
Ring  
Кольцо



AXR-01

Sızdırmaz Vida  
Threaded Pin  
Резьбовой Винт



2705-G1/8x5.5

Anahtar  
Allen Key  
Ключ



AAL-03-3



KAPR=93°

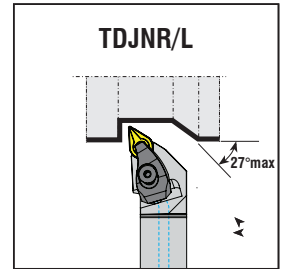
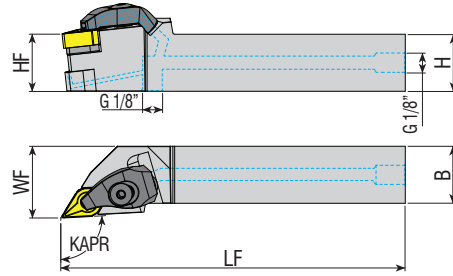

**Takım Kodu**  
**Ordering Code**  
 Код для заказа

Stok Stock Наличие		Takım Ölçüleri (mm) Dimension (mm) Размеры (мм)				
R	L	HF=H	B	LF	WF	

TDJNR/L 2020 K15-H  
 2525 M15-H  
 3232 P15-H

●	●	20	20	125	25
●	●	25	25	150	32
●	●	32	32	170	40

Kesici Uç  
Insert  
Пластина



DNM. 1506..

Baskı Pabucu  
Wedge Clamp  
Прижим



ATKH-01-R  
 ATKH-02-L

Pabuç Vidası  
Clamp Screw  
Закрепной винт



AKV-33-M6x22

Aitlik Shim  
Отпорная пластина



AADN-3-0001

Aitlik Vidası  
Shim Screw  
Винт отпорной пластины



AAV-13-M5x8

Yay  
Spring  
Пружина



AKY-01

Oring  
Ring  
Кольцо



AXR-01

Sızdırmaz Vida  
Threaded Pin  
Резьбовой Винт



2705-G1/8x5.5

Anahtar  
Allen Key  
Ключ



AAL-03-3

R: Sağ / Right / Правый L: Sol / Left / Левый  
 ● Stokta / In Stock / В наличии ○ Stokta Yok / Non Stock Item / Нет в наличии

Sipariş Örneği/Ordering Example/Образец заказа  
 1 ad./pcs./шт. TCLNR 2020 K12-H

T-SİSTEM İÇTEN SOĞUTMA KANALLI DIŞ TORNA KATERLERİ  
T-SYSTEM EXTERNAL TURNING TOOLHOLDERS WITH COOLANT HOLE  
T-ТИП ДЕРЖАВКИ ДЛЯ НАРУЖНОГО ТОЧЕНИЕ С ПОДВОДОМ СОЖ

new

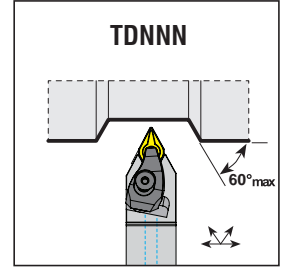
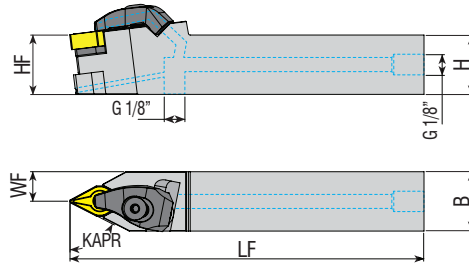

Takım Kodu Ordering Code Код для заказа	Stok Stock Наличие		Takım Ölçüleri (mm) Dimension (mm) Размеры (мм)				Kesici Uç Insert Пластина	Yedek Parçaları / Spare Parts / Запасные части								
	R	L	HF=H	B	LF	WF		Baskı Pabucu Wedge Clamp Прижим	Pabuç Vidası Clamp Screw Зажимный винт	Altlık Shim Оторная пластина	Altlık Vidası Shim Screw Винт оторной пластины	Yay Spring Пружина	Oring Ring Кольцо	Sızdırmaz Vida Threaded Pin Резьбовой Винт	Anahtar Allen Key Ключ	
TDNNN 2525 M15-H	●		25	25	150	32										

new

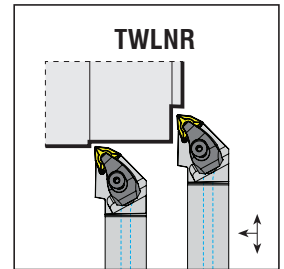
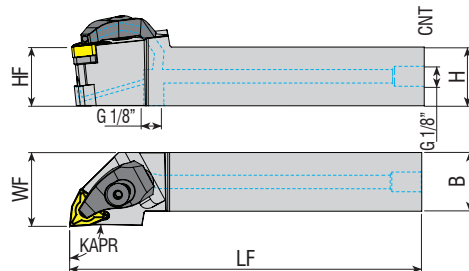

Takım Kodu Ordering Code Код для заказа	Stok Stock Наличие		Takım Ölçüleri (mm) Dimension (mm) Размеры (мм)				Kesici Uç Insert Пластина	Yedek Parçaları / Spare Parts / Запасные части																
	R	L	HF=H	B	LF	WF		Baskı Pabucu Wedge Clamp Прижим	Pabuç Vidası Clamp Screw Зажимный винт	Altlık Shim Оторная пластина	Altlık Vidası Shim Screw Винт оторной пластины	Yay Spring Пружина	Oring Ring Кольцо	Sızdırmaz Vida Threaded Pin Резьбовой Винт	Anahtar Allen Key Ключ									
TWLNR/L 2020 K08-H	●	●	20	20	125	25																		
2525 M08-H	●	●	25	25	150	32										WNN. 0804..	ATKH-01-R	AKV-33-M6x22	AAWN-3-0001	AAV-13-M5x8	AKY-01	AXR-01	2705-G1/8x5.5	AAL-03-3
3232 P08-H	●	●	32	32	170	40										ATKH-02-L								

R: Sağ / Right / Правый L: Sol / Left / Левый

● Stokta / In Stock / В наличии ○ Stokta Yok / Non Stock Item / Нет в наличии

Sipariş Örneği/Ordering Example/Образец заказа

1 ad./pcs./шт. TDNNN 2525 M15-H

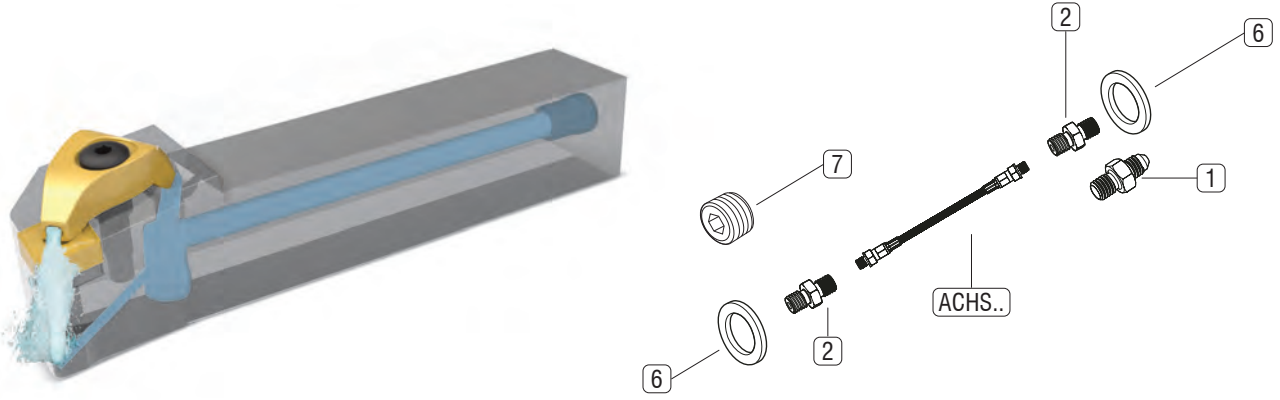

Not: İçten soğutmalı tüm torna katerlerinde kullanılabilir 3 tip soğutma hortum setleri tasarlanmıştır. Takımların kullanılmasından önce, kullanılmayan bağlantıların set içindeki vida ile kapatılarak sızdırmazlığın sağlanmasına dikkat edilmelidir. Torna katerlerine yönelik soğutma hortum setleri, ACHS... 10 bar ile maksimum 275 bar basınç aralığında kullanılabilir.

Note: 3 types of cooling hose sets are designed that can be used in all internally cooled lathes. Before using the tools, care should be taken to ensure that the unused connections are closed with the screw in the set and that sealing is ensured. Cooling hose sets for lathe tools can be used in the pressure range of ACHS ... 10 bar to max 275 bar.

Примечание: Предлагается 3 типа комплектов трубок для подвода СОЖ. Они могут использоваться на всех токарных станках оснащенных системой подвода СОЖ. Перед началом работ необходимо закрыть неиспользуемые соединения винтом из набора и обеспечить герметичность системы подвода СОЖ. Комплекты охлаждающих трубок, для токарных инструментов, могут использоваться в диапазоне давлений ACHS .... от 10 бар до 275 бар.

Set içindeki Parçalar Parts In The Set Запчасти в Наборе				Uzunluk / Length Code / Длина		
				Set Kodu: Set Code: Код Набора: ACHS-1-250	Set Kodu: Set Code: Код Набора: ACHS-2-250	Set Kodu: Set Code: Код Набора: ACHS-3-250
	Resim Picture Рисунок	Takım Kodu Set Code Код Набора	Ürün Açıklaması Product Description Описание товара			
1		AMP-01	M10 Bağlantı Elemanı M10 Fastener Застежка M10	1x	-	-
2		AMP-02	G 1/8" Çift Bağlantı Elemanı G 1/8" Double Fastener G 1/8" двойная застежка	2x	1x	-
3		AMP-03	G 1/8" Açılı Bağlantısı G 1/8" Angle Connection G 1/8" угловое соединение	-	1x	2x
4		AMP-04	M10" Açılı Bağlantısı M10" Angle Connection M10" угловое соединение	-	1x	1x
5		AMP-05	G1/4"-G1/8" Kılcalma Parçası G1 / 4"-G1/8" Capillary Piece G1 / 4"-G1/8" Капиллярная часть	-	1x	1x
6		AG-01	Bakır Conta Copper Gasket Медная прокладка	2x	3x	4x
7		2705-G1/8-5.5	G1/8" Sızdırmaz Civata G1/8" Sealing Bolt G1/8" Уплотнительный болт	1x	1x	1x
8		AH-1-250	Hortum Hose Трубка	1x	-	-
9		AH-2-250	Hortum Hose Трубка	-	1x	-
10		AH-3-250	Hortum Hose Трубка	-	-	1x



*konusulan  
the spoken kalite...  
quality...*

# M-SİSTEM

**M-SİSTEM DIŞ TORNA KATERLERİ**  
M-SYSTEM EXTERNAL TURNING TOOLHOLDERS  
M-ТИП ДЕРЖАВКИ ДЛЯ НАРУЖНОГО ТОЧЕНИЯ



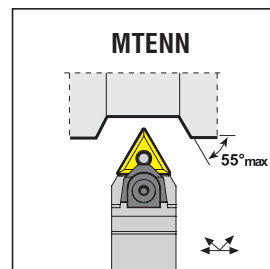
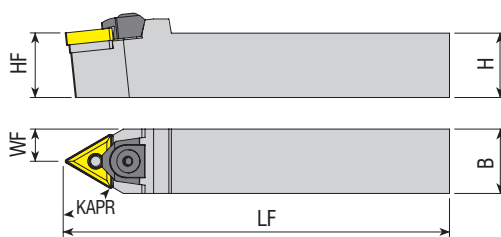

Takım Kodu Ordering Code Код для заказа	Stok Stock Наличие		Takım Ölçüleri (mm) Dimension (mm) Размеры (мм)				Kesici Uç Insert Пластина	Yedek Parçaları / Spare Parts / Запасные части						
	HF=H	B	LF	WF	Baskı Pabuçu Wedge Clamp Прижим	Pabuç Vidası Clamp Screw Закрепительный винт		Altlık Shim Опорная пластина	Pim Pin Штифт	Sekman Ring Кольцо	Pul Stamp Шайба	Anahtar Allen Key Ключ		
													HF=H	B
<b>MTENN 2020 K16</b>	●		20	20	125	10	TNM. 1604..	AMK-04	AKV-30-M6x22	AATN-2-0002	APM-01	AS-01	ABPL-01	AAL-03-3
<b>2525 M16</b>	●		25	25	150	12.5								
<b>3232 P16</b>	●		32	32	170	16								
<b>2525 M22</b>	●		25	25	150	12.5	TNM. 2204..	AMK-08	AKV-30-M6x22	AATN-3-0015	APM-02	AS-01	ABPL-01	AAL-03-3
<b>3232 P22</b>	●		32	32	170	16								
<b>4040 S22</b>	●		40	40	250	20								

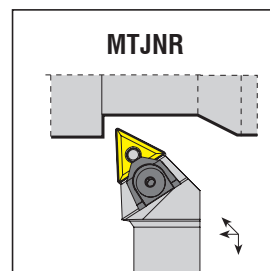
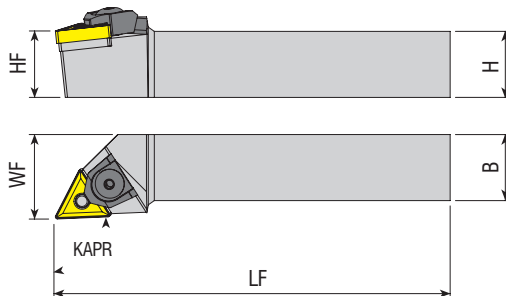
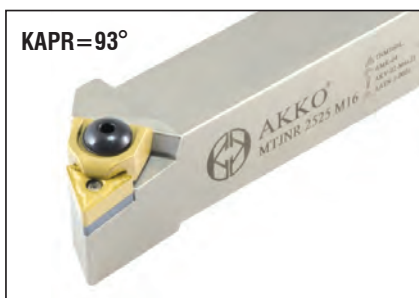

Takım Kodu Ordering Code Код для заказа	Stok Stock Наличие		Takım Ölçüleri (mm) Dimension (mm) Размеры (мм)				Kesici Uç Insert Пластина	Yedek Parçaları / Spare Parts / Запасные части						
	R	L	HF=H	B	LF	WF		Baskı Pabuçu Wedge Clamp Прижим	Pabuç Vidası Clamp Screw Закрепительный винт	Altlık Shim Опорная пластина	Pim Pin Штифт	Sekman Ring Кольцо	Pul Stamp Шайба	Anahtar Allen Key Ключ
<b>MTJNR/L 2020 K16</b>	●	●	20	20	125	25	TNM. 1604..	AMK-04	AKV-30-M6x22	AATN-2-0002	APM-01	AS-01	ABPL-01	AAL-03-3
<b>2525 M16</b>	●	●	25	25	150	32								
<b>3232 P16</b>	●	●	32	32	170	40								
<b>2525 M22</b>	●	●	25	25	150	32	TNM. 2204..	AMK-08	AKV-30-M6x22	AATN-3-0015	APM-02	AS-01	ABPL-01	AAL-03-3
<b>3232 P22</b>	●	●	32	32	170	40								
<b>4040 S22</b>	●	●	40	40	250	50								

R: Sağ / Right / Правый L: Sol / Left / Левый  
● Stokta / In Stock / В наличии ○ Stokta Yok / Non Stock Item / Нет в наличии

Sipariş Örneği/Ordering Example/Образец заказа  
1 ad./pcs./шт. MTENN 2020 K16



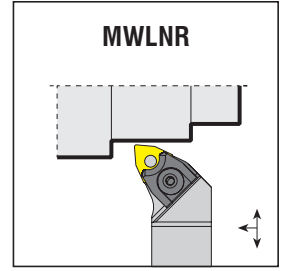
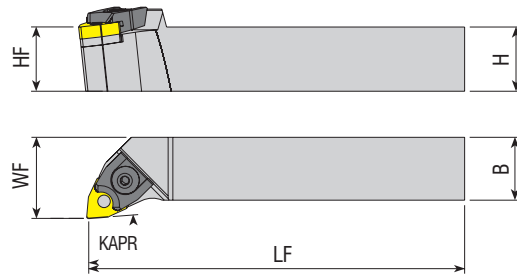

Takım Kodu Ordering Code Код для заказа	Stok Stock Наличие		Takım Ölçüleri (mm) Dimension (mm) Размеры (мм)				Kesici Uç Insert Пластина	Yedek Parçaları / Spare Parts / Запасные части						
	R	L	HF=H	B	LF	WF		Baskı Pabuçu Wedge Clamp Прижим	Pabuç Vidası Clamp Screw Зажимной винт	Altık Shim Опорная пластина	Pim Pin Штифт	Sekman Ring Кольцо	Pul Stamp Шайба	Anahtar Allen Key Ключ
MWLNR/L 1616 H06	●	●	16	16	100	20	WNM. 0604..	AMK-01	AKV-04-M5x17	-	APM-08	-	-	AAL-03-3
2020 K06	●	●	20	20	125	25								
2525 M06	●	●	25	25	150	32								
2020 K08	●	●	20	20	125	25	WNM. 0804..	AMK-05	AKV-03-M6x22	AAWN-3-0001	APM-02	AS-01	ABPL-01	AAL-03-3
2525 M08	●	●	25	25	150	32								
3232 P08	●	●	32	32	170	40								

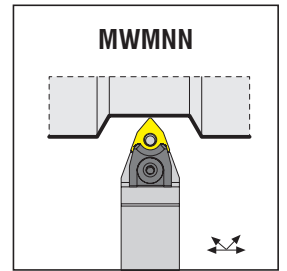
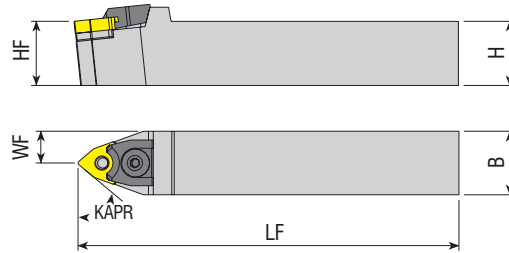

Takım Kodu Ordering Code Код для заказа	Stok Stock Наличие		Takım Ölçüleri (mm) Dimension (mm) Размеры (мм)				Kesici Uç Insert Пластина	Yedek Parçaları / Spare Parts / Запасные части						
	R	L	HF=H	B	LF	WF		Baskı Pabuçu Wedge Clamp Прижим	Pabuç Vidası Clamp Screw Зажимной винт	Altık Shim Опорная пластина	Pim Pin Штифт	Sekman Ring Кольцо	Pul Stamp Шайба	Anahtar Allen Key Ключ
MWMNN 1616 H06	●	●	16	16	100	8	WNM. 0604..	AMK-01	AKV-04-M5x17	-	APM-08	-	-	AAL-03-3
2020 K06	●	●	20	20	125	10								
2525 M06	●	●	25	25	150	12.5								
2020 K08	●	●	20	20	125	10	WNM. 0804..	AMK-05	AKV-03-M6x22	AAWN-3-0001	APM-02	AS-01	ABPL-01	AAL-03-3
2525 M08	●	●	25	25	150	12.5								
3232 P08	●	●	32	32	170	16								

R: Sağ / Right / Правый L: Sol / Left / Левый

● Stokta / In Stock / В наличии ○ Stokta Yok / Non Stock Item / Нет в наличии

Sipariş Örneği/Ordering Example/Образец заказа

1 ad./pcs./шт. MWLNR 1616 H06

# P-SİSTEM

P-SİSTEM DIŞ TORNA KATERLERİ  
P-SYSTEM EXTERNAL TURNING TOOLHOLDERS  
P-ТИП ДЕРЖАВКИ ДЛЯ НАРУЖНОГО ТОЧЕНИЯ

*konusulan*  
*the spoken kalite...*  
*quality...*



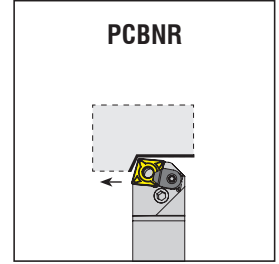
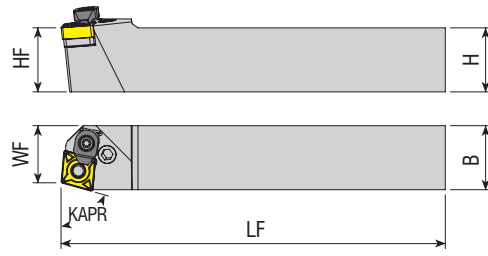

**Takım Kodu**  
**Ordering Code**  
*Kod для заказа*

Stok  
Stock  
Наличие

Takım Ölçüleri (mm)  
Dimension (mm)  
Размеры (мм)

Kesici Uç  
Insert  
Пластина

Yedek Parçaları / Spare Parts / Запасные части

Levyeye  
Lever  
Рычаг

Levyeye Vidası  
Lever Screw  
Винт рычага

Aitlik  
Shim  
Опорная пластина

Aitlik Yayı  
Shim Spring  
Втулка рычага

Baskı Parçası  
Wedge Clamp  
Прижим

Baskı Vidası  
Clamp Screw  
Зажимной винт

Anahtar  
Allen Key  
Ключ

R L

HF=H

B

LF

WF

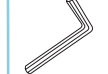

Takım Kodu Ordering Code Код для заказа	R	L	HF=H	B	LF	WF
PCBNR/L 2020 K12C	●	●	20	20	125	17.5
2525 M12C	●	●	25	25	150	22.5
3232 P12C	●	●	32	32	170	29.5
2525 M16C	●	●	25	25	150	22
3232 P16C	●	●	32	32	170	27
3232 P19C	●	●	32	32	170	27
4040 S19C	●	●	40	40	250	37
4040 S25C	●	●	40	40	250	37
5050 S25C	○	○	50	50	250	47

CNM. 1204..

APL-02

ALV-03-M8x19

AACN-3-0001

AAV-02

ACK-05

4015-M4x11

AAL-03-3

CNM. 1606..

APL-04

ALV-04-M8x22

AACN-3-0002

AAV-03

CNM. 1906..

APL-05

ALV-05-M10x27

AACN-3-0003

AAV-04

ACK-09

AAV-05-M6x15

AAL-05-4

CNM. 2509..

APL-06

ALV-06-M12x36

AACN-3-0008

AAV-05

ACK-04

AKV-16-M6x16

AAL-07-5

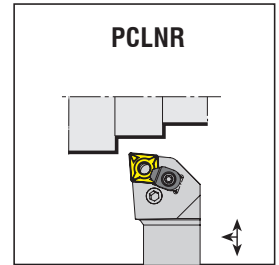
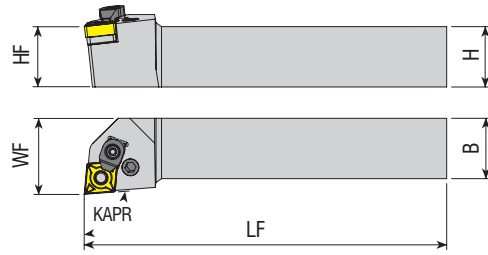

**Takım Kodu**  
**Ordering Code**  
*Kod для заказа*

Stok  
Stock  
Наличие

Takım Ölçüleri (mm)  
Dimension (mm)  
Размеры (мм)

Kesici Uç  
Insert  
Пластина

Yedek Parçaları / Spare Parts / Запасные части

Levyeye  
Lever  
Рычаг

Levyeye Vidası  
Lever Screw  
Винт рычага

Aitlik  
Shim  
Опорная пластина

Aitlik Yayı  
Shim Spring  
Втулка рычага

Baskı Parçası  
Wedge Clamp  
Прижим

Baskı Vidası  
Clamp Screw  
Зажимной винт

Anahtar  
Allen Key  
Ключ

R L

HF=H

B

LF

WF

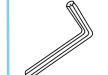

Takım Kodu Ordering Code Код для заказа	R	L	HF=H	B	LF	WF
PCLNR/L 1616 H09	●	●	16	16	100	20
2020 K09	●	●	20	20	125	25
2525 M09	●	●	25	25	150	32
1616 H12	●	●	16	16	100	20
2020 K12C	●	●	20	20	125	25
2525 M12C	●	●	25	25	150	32
3232 P12C	●	●	32	32	170	40
2525 M16C	●	●	25	25	150	32
3232 P16C	●	●	32	32	170	40
2525 M19C	●	●	25	25	150	32
3232 P19C	●	●	32	32	170	40
4040 S19C	●	●	40	40	250	50
4040 S25C	●	●	40	40	250	50
5050 S25C	●	●	50	50	250	60

CNM. 0903..

APL-01

ALV-02-M6x17

AACN-2-0002

AAV-01

-

-

AAL-02-2.5

CNM. 1204..

APL-02

ALV-03-M8x19

AACN-3-0001

AAV-02

ACK-05

4015-M4x11

AAL-03-3

CNM. 1606..

APL-04

ALV-04-M8x22

AACN-3-0002

AAV-03

CNM. 1906..

APL-05

ALV-05-M10x27

AACN-3-0003

AAV-04

ACK-09

AAV-05-M6x15

AAL-05-4

CNM. 2509..

APL-06

ALV-06-M12x36

AACN-3-0008

AAV-05

ACK-04

AKV-16-M6x16

AAL-07-5

R: Sağ / Right / Правый L: Sol / Left / Левый  
● Stokta / In Stock / В наличии ○ Stokta Yok / Non Stock Item / Нет в наличии

Sipariş Örneği/Ordering Example/Образец заказа  
1 ad./pcs./шт. PCBNR 2020 K12C

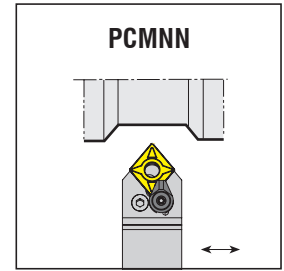
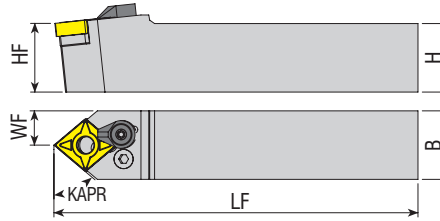

Takım Kodu Ordering Code Код для заказа	Stok Stock Наличие		Takım Ölçüleri (mm) Dimension (mm) Размеры (мм)				Kesici Uç Insert Пластина	Yedek Parçaları / Spare Parts / Запасные части						
	R	L	HF=H	B	LF	WF		Levyeye Lever Рычаг	Levyeye Vidası Lever Screw Винт рычага	Altılık Shim Опорная пластина	Altılık Yay Shim Spring Втулка рычага	Baskı Parçası Wedge Clamp Прижим	Baskı Vidası Clamp Screw Зажимной винт	Anahtar Allen Key Ключ
PCMN 2020 K12C	●		20	20	125	10	CNM. 1204..	APL-02	ALV-03-M8x19	AACN-3-0001	AAY-02	ACK-05	4015-M4x11	AAL-03-3
2525 M12C	●		25	25	150	12.5								
3232 P12C	○		32	32	170	16	CNM. 1606..	APL-04	ALV-04-M8x22	AACN-3-0002	AAY-03			
2525 M16C	○		25	25	150	12.5								
3232 P16C	○		32	32	170	16	CNM. 1906..	APL-05	ALV-05-M10x27	AACN-3-0003	AAY-04	ACK-09	AAV-05-M6x15	AAL-05-4
3232 P19C	●		32	32	170	16								
4040 S19C	●		40	40	250	20	CNM. 2509..	APL-06	ALV-06-M12x36	AACN-3-0008	AAY-05	ACK-04	AKV-16-M6x16	AAL-07-5
4040 S25C	●		40	40	250	20								

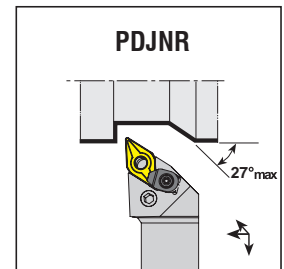
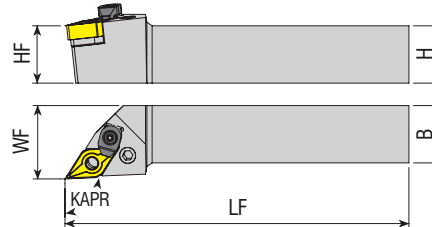

Takım Kodu Ordering Code Код для заказа	Stok Stock Наличие		Takım Ölçüleri (mm) Dimension (mm) Размеры (мм)				Kesici Uç Insert Пластина	Yedek Parçaları / Spare Parts / Запасные части						
	R	L	HF=H	B	LF	WF		Levyeye Lever Рычаг	Levyeye Vidası Lever Screw Винт рычага	Altılık Shim Опорная пластина	Altılık Yay Shim Spring Втулка рычага	Baskı Parçası Wedge Clamp Прижим	Baskı Vidası Clamp Screw Зажимной винт	Anahtar Allen Key Ключ
PDJNR/L 1616 H11	●	●	16	16	100	20	DNM. 1104..	APL-01	ALV-02-M6x17	AADN-SD317	AAY-01	-	-	AAL-02-2.5
2020 K11	●	●	20	20	125	25								
2525 M11	●	●	25	25	150	32								
2020 K15C	●	●	20	20	125	25	DNM. 1506..	APL-03	ALV-03-M8x19	AADN-3-0001	AAY-02	ACK-05	4015-M4x11	AAL-03-3
2525 M15C	●	●	25	25	150	32								
3232 P15C	●	●	32	32	170	40								
4040 S15C	●	●	40	40	250	50								

R: Sağ / Right / Правый L: Sol / Left / Левый

● Stokta / In Stock / В наличии ○ Stokta Yok / Non Stock Item / Нет в наличии

Sipariş Örneği/Ordering Example/Образец заказа

1 ad./pcs./шт. PCMN 2020 K12C

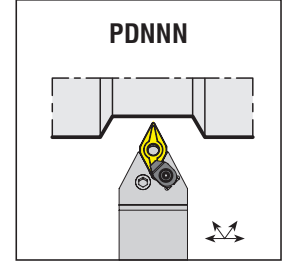
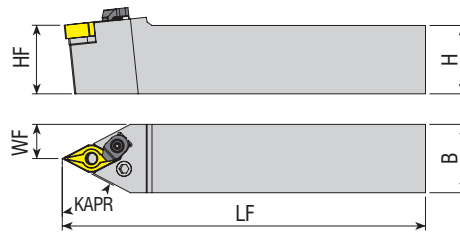

Takım Kodu Ordering Code Код для заказа	Stok Stock Наличие	Takım Ölçüleri (mm) Dimension (mm) Размеры (мм)				Kesici Uç Insert Пластина	Yedek Parçaları / Spare Parts / Запасные части							
		HF=H	B	LF	WF		Levye Lever Рычаг	Levye Vidası Lever Screw Винт рычага	Altlık Shim Опорная пластина	Altlık Yayı Shim Spring Втулка рычага	Baskı Parçası Wedge Clamp Трижим	Baskı Vidası Clamp Screw Зажимной винт	Anahtar Allen Key Ключ	
PDNNN 1616 H11	●	16	16	100	8									
2020 K11	●	20	20	125	10	DNM. 1104..	APL-01	ALV-02-M6x17	AADN-SD317	AAY-01	-	-	AAL-02-2.5	
2525 M11	●	25	25	150	12.5									
2020 K15C	●	20	20	125	10									
2525 M15C	●	25	25	150	12.5	DNM. 1506..	APL-03	ALV-03-M8x19	AADN-3-0001	AAY-02	ACK-05	4015-M4x11	AAL-03-3	
3232 P15C	●	32	32	170	16									

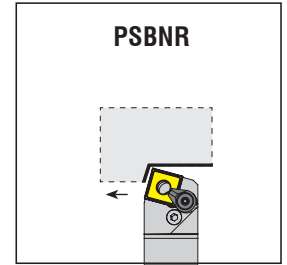
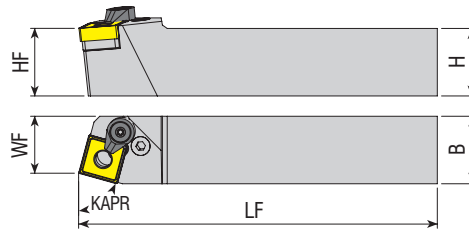
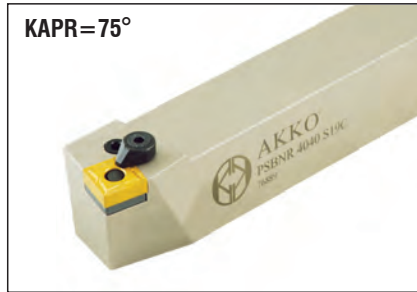

Takım Kodu Ordering Code Код для заказа	Stok Stock Наличие		Takım Ölçüleri (mm) Dimension (mm) Размеры (мм)				Kesici Uç Insert Пластина	Yedek Parçaları / Spare Parts / Запасные части							
	R	L	HF=H	B	LF	WF		Levye Lever Рычаг	Levye Vidası Lever Screw Винт рычага	Altlık Shim Опорная пластина	Altlık Yayı Shim Spring Втулка рычага	Baskı Parçası Wedge Clamp Трижим	Baskı Vidası Clamp Screw Зажимной винт	Anahtar Allen Key Ключ	
PSBNR/L 1616 H09	●	●	16	16	100	13									
2020 K09	○	○	20	20	125	17	SNM. 0903..	APL-01	ALV-02-M6x17	AASN-2-0002	AAY-01	-	-	AAL-02-2.5	
2020 K12	●	●	20	20	125	17									
2525 M12C	●	●	25	25	150	22	SNM. 1204..	APL-02	ALV-03-M8x19	AASN-3-0004	AAY-02	ACK-05	4015-M4x11	AAL-03-3	
3232 P12C	●	●	32	32	170	27									
2525 M15	●	●	25	25	150	22	SNM. 1506..	APL-04	ALV-04-M8x22	AASN-3-0023	AAY-03	-	-		
3232 P15C	●	●	32	32	170	27									
3232 P19C	●	●	32	32	170	27	SNM. 1906..	APL-05	ALV-05-M10x27	AASN-3-0005	AAY-04	ACK-09	AAV-05-M6x15	AAL-05-4	
4040 S19C	●	●	40	40	250	35									
4040 S25C	●	●	40	40	250	35	SNM. 2509..	APL-06	ALV-06-M12x36	AASN-3-0020	AAY-05	ACK-04	AKV-16-M6x16	AAL-07-5	
5050 S25C	●	○	50	50	250	43									

R: Sağ / Right / Правый L: Sol / Left / Левый  
● Stokta / In Stock / В наличии ○ Stokta Yok / Non Stock Item / Нет в наличии

Sipariş Örneği/Ordering Example/Образец заказа  
1 ad./pcs./шт. PDNNN 1616 H11

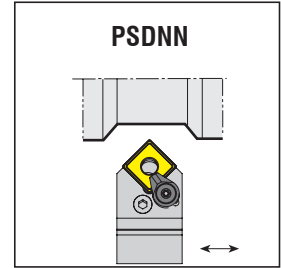
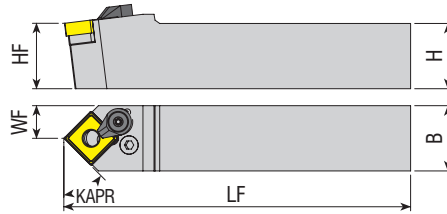

Takım Kodu Ordering Code Код для заказа	Stok Stock Наличие	Takım Ölçüleri (mm) Dimension (mm) Размеры (мм)				Kesici Uç Insert Пластина	Yedek Parçaları / Spare Parts / Запасные части						
		HF=H	B	LF	WF		Levyeye Lever Рычаг	Levyeye Vidası Lever Screw Винт рычага	Altılık Shim Опорная пластина	Altılık Yayı Shim Spring Втулка рычага	Baskı Parçası Wedge Clamp Прижим	Baskı Vidası Clamp Screw Зажимной винт	Anahtar Allen Key Ключ
PSDNN 1616 H09	●	16	16	100	8	SNM. 0903..	APL-01	ALV-02-M6x17	AASN-2-0002	AAAY-01	-	-	AAL-02-2.5
2020 K12C	●	20	20	125	10	SNM. 1204..	APL-02	ALV-03-M8x19	AASN-3-0004	AAAY-02	ACK-05	4015-M4x11	AAL-03-3
2525 M12C	●	25	25	150	12.5								
3232 P12C	●	32	32	170	16								
2020 K15	●	20	20	125	10	SNM. 1506..	APL-04	ALV-04-M8x22	AASN-3-0023	AAAY-03	-	-	AAL-05-4
2525 M15C	●	25	25	150	12.5								
3232 P19C	●	32	32	170	16								
4040 S19C	○	40	40	250	20	SNM. 1906..	APL-05	ALV-05-M10x27	AASN-3-0005	AAAY-04	ACK-09	AAV-05-M6x15	AAL-05-4
5050 S19C	○	50	50	250	25	SNM. 2509..	APL-06	ALV-06-M12x36	AASN-3-0020	AAAY-05	ACK-04	AKV-16-M6x16	AAL-07-5
4040 S25C	●	40	40	250	20								
5050 S25C	○	50	50	250	25								

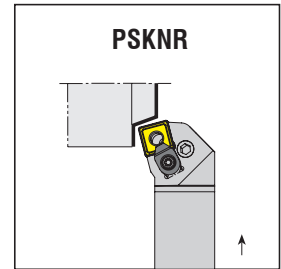
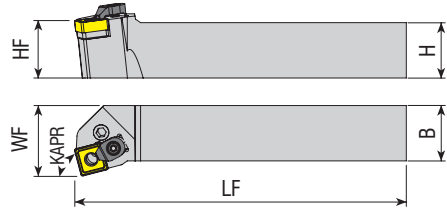

Takım Kodu Ordering Code Код для заказа	Stok Stock Наличие		Takım Ölçüleri (mm) Dimension (mm) Размеры (мм)				Kesici Uç Insert Пластина	Yedek Parçaları / Spare Parts / Запасные части						
	R	L	HF=H	B	LF	WF		Levyeye Lever Рычаг	Levyeye Vidası Lever Screw Винт рычага	Altılık Shim Опорная пластина	Altılık Yayı Shim Spring Втулка рычага	Baskı Parçası Wedge Clamp Прижим	Baskı Vidası Clamp Screw Зажимной винт	Anahtar Allen Key Ключ
PSKNR/L 2020 K09	●	○	20	20	125	25	SNM. 0903..	APL-01	ALV-02-M6x17	AASN-2-0002	AAAY-01	-	-	AAL-02-2.5
2020 K12C	●	●	20	20	125	25	SNM. 1204..	APL-02	ALV-03-M8x19	AASN-3-0004	AAAY-02	ACK-05	4015-M4x11	AAL-03-3
2525 M12C	●	●	25	25	150	32								
3232 P12C	●	●	32	32	170	40								
2525 M15C	●	●	25	25	150	32	SNM. 1506..	APL-04	ALV-04-M8x22	AASN-3-0023	AAAY-03	-	-	AAL-05-4
3232 P15C	●	●	32	32	170	40								
3232 P19C	●	●	32	32	170	40								
4040 S19C	●	●	40	40	250	50	SNM. 1906..	APL-05	ALV-05-M10x27	AASN-3-0005	AAAY-04	ACK-09	AAV-05-M6x15	AAL-05-4
4040 S25C	●	●	40	40	250	50	SNM. 2509..	APL-06	ALV-06-M12x36	AASN-3-0020	AAAY-05	ACK-04	AKV-16-M6x16	AAL-07-5
5050 S25C	●	○	50	50	250	60								

R: Sağ / Right / Правый L: Sol / Left / Левый  
● Stokta / In Stock / В наличии ○ Stokta Yok / Non Stock Item / Нет в наличии

Sipariş Örneği/Ordering Example/Образец заказа  
1 ad./pcs./шт. PSDNN 1616 H09

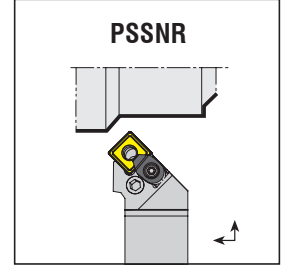
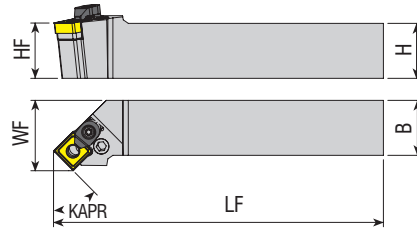

Takım Kodu Ordering Code Код для заказа	Stok Stock Наличие		Takım Ölçüleri (mm) Dimension (mm) Размеры (мм)				Kesici Uç Insert Пластина	Yedek Parçaları / Spare Parts / Запасные части						
	R	L	HF=H	B	LF	WF		Levyeye Lever Рычаг	Levyeye Vidası Lever Screw Винт рычага	Altılık Shim Опорная пластина	Altılık Yayı Shim Spring Втулка рычага	Baskı Parçası Wedge Clamp Прижим	Baskı Vidası Clamp Screw Зажимной винт	Anahtar Allen Key Ключ
PSSNR/L 1616 H09	●	●	16	16	100	20	SNM. 0903..	APL-01	ALV-02-M6x17	AASN-2-0002	AAY-01	-	-	AAL-02-2.5
2020 K09	●	○	20	20	125	25								
2020 K12C	●	●	20	20	125	25	SNM. 1204..	APL-02	ALV-03-M8x19	AASN-3-0004	AAY-02	ACK-05	4015-M4x11	AAL-03-3
2525 M12C	●	●	25	25	150	32								
3232 P12C	●	●	32	32	170	40	SNM. 1506..	APL-04	ALV-04-M8x22	AASN-3-0023	AAY-03			
3232 P15C	●	○	32	32	170	40								
3232 P19C	●	●	32	32	170	40	SNM. 1906..	APL-05	ALV-05-M10x27	AASN-3-0005	AAY-04	ACK-09	AAV-05-M6x15	AAL-05-4
4040 S19C	●	●	40	40	250	50								
4040 S25C	●	●	40	40	250	50	SNM. 2509..	APL-06	ALV-06-M12x36	AASN-3-0020	AAY-05	ACK-04	AKV-16-M6x16	AAL-07-5

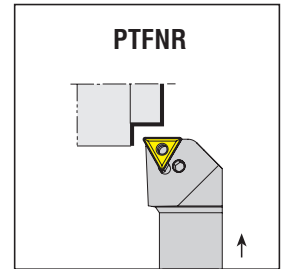
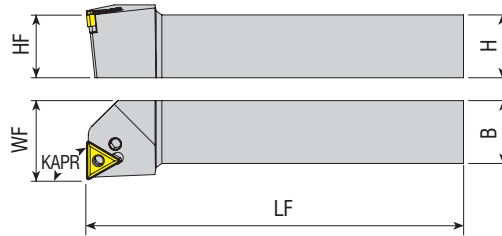

Takım Kodu Ordering Code Код для заказа	Stok Stock Наличие		Takım Ölçüleri (mm) Dimension (mm) Размеры (мм)				Kesici Uç Insert Пластина	Yedek Parçaları / Spare Parts / Запасные части						
	R	L	HF=H	B	LF	WF		Levyeye Lever Рычаг	Levyeye Vidası Lever Screw Винт рычага	Altılık Shim Опорная пластина	Altılık Yayı Shim Spring Втулка рычага	Baskı Parçası Wedge Clamp Прижим	Baskı Vidası Clamp Screw Зажимной винт	Anahtar Allen Key Ключ
PTFNR/L 1616 H16	●	●	16	16	100	20	TNM. 1604..	APL-01	ALV-02-M6x17	AATN-3-0025	AAY-01	-	-	AAL-02-2.5
2020 K16	●	●	20	20	125	25								
2525 M16	●	●	25	25	150	32								
3232 P16	●	●	32	32	170	40	TNM. 2204..	APL-02	ALV-03-M8x19	AATN-3-0015	AAY-02	ACK-05	4015-M4x11	AAL-03-3
2525 M22C	●	●	25	25	150	32								
3232 P22C	●	●	32	32	170	40	TNM. 2706..	APL-05	ALV-05-M10x27	07042701	AAY-04	ACK-09	AAV-05-M6x15	AAL-05-4
4040 S27C	○	○	40	40	250	50								

R: Sağ / Right / Правый L: Sol / Left / Левый  
● Stokta / In Stock / В наличии ○ Stokta Yok / Non Stock Item / Нет в наличии

Sipariş Örneği/Ordering Example/Образец заказа  
1 ad./pcs./шт. PSSNR 1616 H09

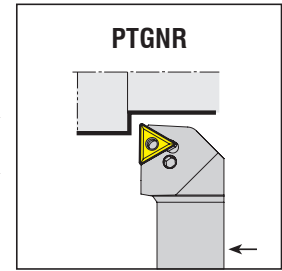
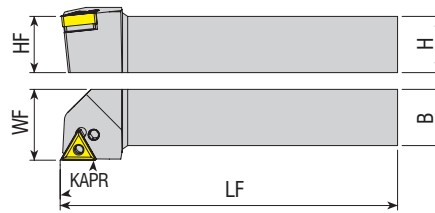

Takım Kodu Ordering Code Код для заказа	Stok Stock Наличие		Takım Ölçüleri (mm) Dimension (mm) Размеры (мм)				Kesici Uç Insert Пластина	Yedek Parçaları / Spare Parts / Запасные части							
	R	L	HF=H	B	LF	WF		Levye	Levye Vidası	Altılık	Altılık Yay	Baskı Parçası	Baskı Vidası	Anahtar	
								Lever	Lever Screw	Shim	Shim Spring	Wedge Clamp	Clamp Screw	Allen Key	
PTGNR/L 1010 E11	○	○	10	10	70	12	TNM. 1103..	APL-11	ALV-10-M5X10	-	-	-	-	AAL-13-2.5	
1212 F11	○	○	12	12	80	16		TNM. 1604..	APL-01	ALV-02-M6x17	AATN-3-0025	AAY-01	-	-	AAL-02-2.5
1616 H11	○	○	16	16	100	20									
1616 H16	●	●	16	16	100	20									
2020 K16	●	●	20	20	125	25									
2525 M16	●	●	25	25	150	32									
3232 P16	○	○	32	32	170	40	TNM. 2204..	APL-02	ALV-03-M8x19	AATN-3-0015	AAY-02	ACK-05	4015-M4x11	AAL-03-3	
2525 M22C	●	●	25	25	150	32									
3232 P22C	●	●	32	32	170	40									
4040 S27C	○	○	40	40	250	50	TNM. 2706..	APL-05	ALV-05-M10x27	07042701	AAY-04	ACK-09	AAV-05-M6x15	AAL-05-4	

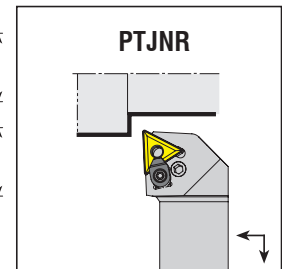
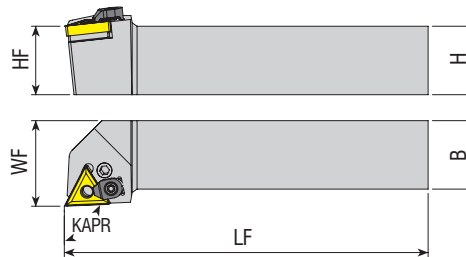

Takım Kodu Ordering Code Код для заказа	Stok Stock Наличие		Takım Ölçüleri (mm) Dimension (mm) Размеры (мм)				Kesici Uç Insert Пластина	Yedek Parçaları / Spare Parts / Запасные части							
	R	L	HF=H	B	LF	WF		Levye	Levye Vidası	Altılık	Altılık Yay	Baskı Parçası	Baskı Vidası	Anahtar	
								Lever	Lever Screw	Shim	Shim Spring	Wedge Clamp	Clamp Screw	Allen Key	
PTJNR/L 1010 E11	○	○	10	10	70	12	TNM. 1103..	APL-11	ALV-10-M5X10	-	-	-	-	AAL-13-2.5	
1212 F11	○	○	12	12	80	16		TNM. 1604..	APL-01	ALV-02-M6x17	AATN-3-0025	AAY-01	-	-	AAL-02-2.5
1616 H11	○	○	16	16	100	20									
1616 H16	●	●	16	16	100	20									
2020 K16	●	●	20	20	125	25									
2525 M16	●	●	25	25	150	32									
3232 P16	●	●	32	32	170	40	TNM. 2204..	APL-02	ALV-03-M8x19	AATN-3-0015	AAY-02	ACK-05	4015-M4x11	AAL-03-3	
2525 M22C	●	●	25	25	150	32									
3232 P22C	●	●	32	32	170	40									
4040 S27C	○	○	40	40	250	50	TNM. 2706..	APL-05	ALV-05-M10x27	07042701	AAY-04	ACK-09	AAV-05-M6x15	AAL-05-4	

R: Sağ / Right / Правый L: Sol / Left / Левый  
● Stokta / In Stock / В наличии ○ Stokta Yok / Non Stock Item / Нет в наличии

Sipariş Örneği/Ordering Example/Образец заказа  
1 ad./pcs./шт. PTGNR 1010 E11



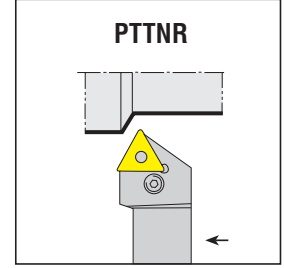
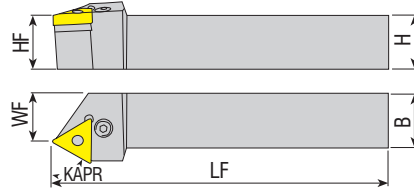
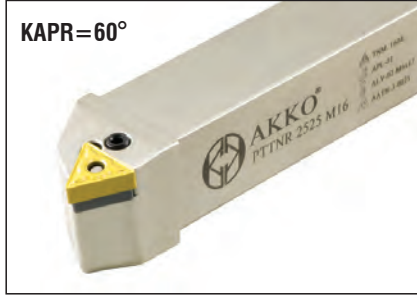

Takım Kodu Ordering Code Код для заказа	Stok Stock Наличие		Takım Ölçüleri (mm) Dimension (mm) Размеры (мм)				Kesici Uç Insert Пластина	Yedek Parçaları / Spare Parts / Запасные части						
	R	L	HF=H	B	LF	WF		Levyeye Lever Рычаг	Levyeye Vidası Lever Screw Винт рычага	Altılık Shim Опорная пластина	Altılık Yayı Shim Spring Втулка рычага	Baskı Parçası Wedge Clamp Прижим	Baskı Vidası Clamp Screw Зажимной винт	Anahtar Allen Key Ключ
<b>PTTNR/L 1616 H16</b>	●	●	16	16	100	13	<b>TNM. 1604..</b>	APL-01	ALV-02-M6x17	AATN-3-0025	AAV-01	-	-	AAL-02-2.5
<b>2020 K16</b>	●	●	20	20	125	17								
<b>2525 M16</b>	●	●	25	25	150	21.5								
<b>3232 P16</b>	●	●	32	32	170	31								
<b>2525 M22C</b>	●	●	25	25	150	20.5	<b>TNM. 2204..</b>	APL-02	ALV-03-M8x19	AATN-3-0015	AAV-02	ACK-05	4015-M4x11	AAL-03-3
<b>3232 P22C</b>	●	●	32	32	170	29								

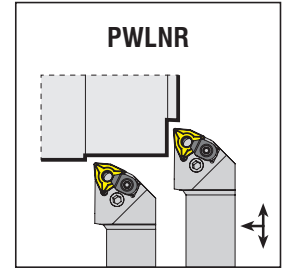
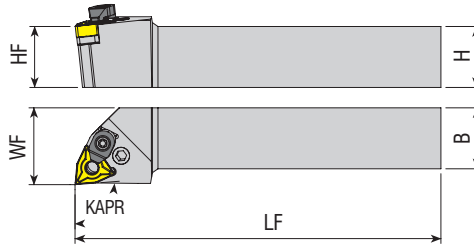

Takım Kodu Ordering Code Код для заказа	Stok Stock Наличие		Takım Ölçüleri (mm) Dimension (mm) Размеры (мм)				Kesici Uç Insert Пластина	Yedek Parçaları / Spare Parts / Запасные части						
	R	L	HF=H	B	LF	WF		Levyeye Lever Рычаг	Levyeye Vidası Lever Screw Винт рычага	Altılık Shim Опорная пластина	Altılık Yayı Shim Spring Втулка рычага	Baskı Parçası Wedge Clamp Прижим	Baskı Vidası Clamp Screw Зажимной винт	Anahtar Allen Key Ключ
<b>PWLNR/L 1616 H06</b>	●	●	16	16	100	20	<b>WNM. 0604..</b>	APL-01	ALV-02-M6x17	AAWN-SW317	AAV-01	-	-	AAL-02-2.5
<b>2020 K06</b>	●	●	20	20	125	25								
<b>2525 M06</b>	●	●	25	25	150	32								
<b>3232 P06</b>	○	○	32	32	170	40								
<b>1616 H08</b>	●	●	16	16	100	20	<b>WNM. 0804..</b>	APL-02	ALV-03-M8x19	AAWN-3-0001	AAV-02	ACK-05	4015-M4x11	AAL-03-3
<b>2020 K08C</b>	●	●	20	20	125	25								
<b>2525 M08C</b>	●	●	25	25	150	32								
<b>3232 P08C</b>	●	●	32	32	170	40								

R: Sağ / Right / Правый L: Sol / Left / Левый  
● Stokta / In Stock / В наличии ○ Stokta Yok / Non Stock Item / Нет в наличии

Sipariş Örneği/Ordering Example/Образец заказа  
1 ad./pcs./шт. PTTNR 1616 H16

# P-SİSTEM

**P-SİSTEM İÇTEN SOĞUTMA KANALLI DIŞ TORNA KATERLERİ**  
P-SYSTEM EXTERNAL TURNING TOOLHOLDERS WITH COOLANT HOLE  
P-ТИП ДЕРЖАВКИ ДЛЯ НАРУЖНОГО ТОЧЕНИЯ С ПОДВОДОМ СОЖ

**konusulan**  
**the spoken kalite...**  
**quality...**



**DETAYLI BİLGİ İÇİN BARKODU OKUTUNUZ**

SCAN ME FOR MORE DETAILS

ПРОСКАНИРУЙТЕ ДЛЯ ПОЛУЧЕНИЯ БОЛЕЕ ПОДРОБНОЙ ИНФОРМАЦИИ

P-SİSTEM İÇTEN SOĞUTMA KANALLI DIŞ TORNA KATERLERİ  
P-SYSTEM EXTERNAL TURNING TOOLHOLDERS WITH COOLANT HOLE  
P-ТИП ДЕРЖАВКИ ДЛЯ НАРУЖНОГО ТОЧЕНИЕ С ПОДВОДОМ СОЖ

new

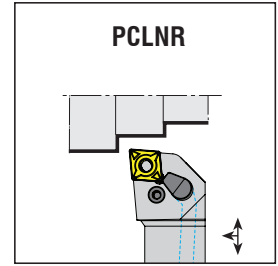
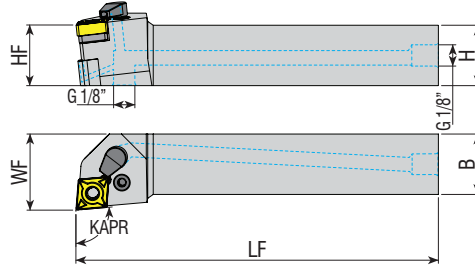

Takım Kodu  
Ordering Code  
Код для заказа

Stok Stock Наличие	Takım Ölçüleri (mm) Dimension (mm) Размеры (мм)						Kesici Uç Insert Пластина	Levyeye Lever Рычаг	Levyeye Vidası Lever Screw Винт рычага	Altılık Shim Опорная пластина	Altılık Yayı Shim Spring Втулка рычага	Oring Ring Кольцо	Sızdırmaz Vida Threaded Pin Резьбовой Винт	Nozul Nozzle Прижим СОЖ	Anahtar Allen Key Ключ
	R	L	HF=H	B	LF	WF									
	●	●	20	20	125	25									
PCLNR/L 2020 K12-H	●	●	20	20	125	25	CNM. 1204..	APL-02	ALV-03-M8x19	AACN-3-0001	AAV-02	AXR-01 AOR-01	2705-G1/8x5.5	AN-01	AAL-03-3
2525 M12-H	●	●	25	25	150	32									
3232 P12-H	●	○	32	32	170	40									

new

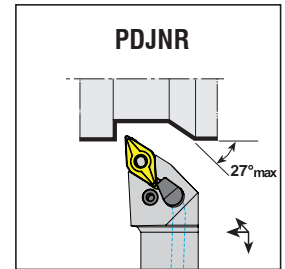
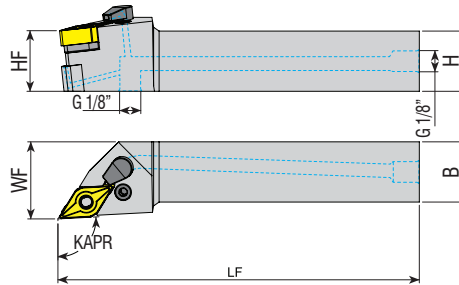

Takım Kodu  
Ordering Code  
Код для заказа

Stok Stock Наличие	Takım Ölçüleri (mm) Dimension (mm) Размеры (мм)						Kesici Uç Insert Пластина	Levyeye Lever Рычаг	Levyeye Vidası Lever Screw Винт рычага	Altılık Shim Опорная пластина	Altılık Yayı Shim Spring Втулка рычага	Oring Ring Кольцо	Sızdırmaz Vida Threaded Pin Резьбовой Винт	Nozul Nozzle Прижим СОЖ	Anahtar Allen Key Ключ
	R	L	HF=H	B	LF	WF									
	●	●	20	20	125	25									
PDJNR/L 2020 K15-H	●	●	20	20	125	25	DNM. 1506..	APL-03	ALV-03-M8x19	AADN-3-0001	AAV-02	AXR-01 AOR-01	2705-G1/8x5.5	AN-01	AAL-03-3
2525 M15-H	●	●	25	25	150	32									
3232 P15-H	●	○	32	32	170	40									

R: Sağ / Right / Правый L: Sol / Left / Левый

● Stokta / In Stock / В наличии ○ Stokta Yok / Non Stock Item / Нет в наличии

Sipariş Örneği/Ordering Example/Образец заказа

1 ad./pcs./шт. PCLNR 2020 K12-H

**AKKO**

www.akko.com.tr

new

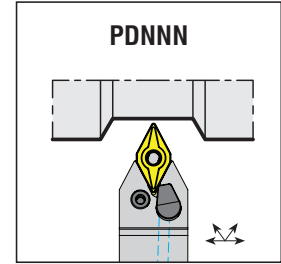
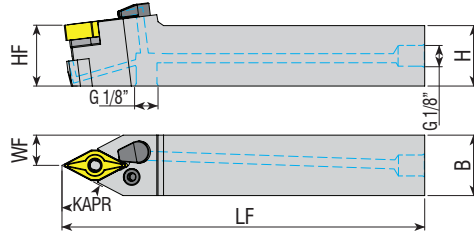

Takım Kodu Ordering Code Код для заказа	Stok Stock Наличие	Takım Ölçüleri (mm) Dimension (mm) Размеры (мм)				Kesici Uç Insert Пластина	Yedek Parçaları / Spare Parts / Запасные части									
		HF=H	B	LF	WF		Levyeye Lever Рычаг	Levyeye Vidası Lever Screw Винт рычага	Altılık Shim Отверная пластина	Altılık Yayı Shim Spring Втулка рычага	Oring Ring Кольцо	Sızdırmaz Vida Threaded Pin Резьбовой Винт	Nozul Nozzle Прижим СОЖ	Anahtar Allen Key Ключ		
PDNNN 2525 M15-H	●	25	25	150	32											
						<b>DNM. 1506..</b>	APL-03	ALV-03-M8x19	AADN-3-0001	AAV-02	AXR-01 AOR-01	2705-G1/8x5.5	AN-01	AAL-03-3		

new

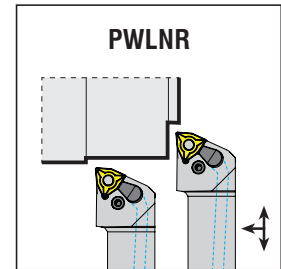
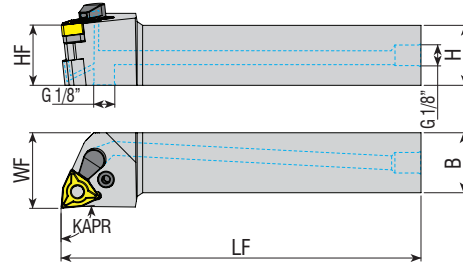

Takım Kodu Ordering Code Код для заказа	Stok Stock Наличие		Takım Ölçüleri (mm) Dimension (mm) Размеры (мм)				Kesici Uç Insert Пластина	Yedek Parçaları / Spare Parts / Запасные части									
	R	L	HF=H	B	LF	WF		Levyeye Lever Рычаг	Levyeye Vidası Lever Screw Винт рычага	Altılık Shim Отверная пластина	Altılık Yayı Shim Spring Втулка рычага	Oring Ring Кольцо	Sızdırmaz Vida Threaded Pin Резьбовой Винт	Nozul Nozzle Прижим СОЖ	Anahtar Allen Key Ключ		
PWLNR/L 2020 K08-H	●	●	20	20	125	25											
2525 M08-H	●	●	25	25	150	32	<b>WNM. 0804..</b>	APL-02	ALV-03-M8x19	AAWN-3-0001	AAV-02	AXR-01 AOR-01	2705-G1/8x5.5	AN-01	AAL-03-3		

R: Sağ / Right / Правый L: Sol / Left / Левый  
● Stokta / In Stock / В наличии ○ Stokta Yok / Non Stock Item / Нет в наличии

Sipariş Örneği/Ordering Example/Образец заказа  
1 ad./pcs./шт. PDNNN 2525 M15-H

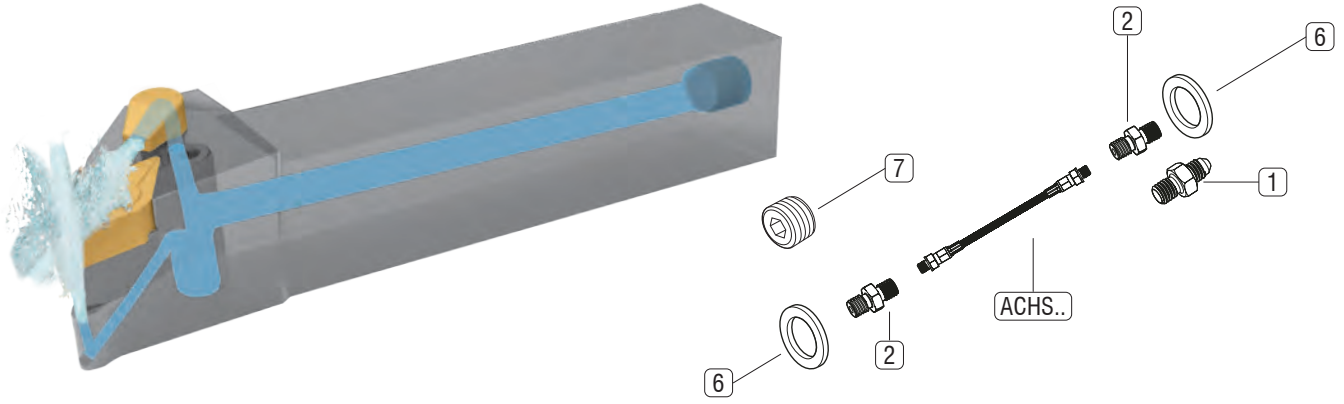

Not: İçten soğutmalı tüm torna katerlerinde kullanılacak 3 tip soğutma hortum setleri tasarlanmıştır. Takımların kullanılmasından önce, kullanılmayan bağlantıların set içindeki vida ile kapatılarak sızdırmazlığın sağlanmasına dikkat edilmelidir. Torna katerlerine yönelik soğutma hortum setleri, ACHS... 10 bar ile maksimum 275 bar basınç aralığında kullanılabilir.

Note: 3 types of cooling hose sets are designed that can be used in all internally cooled lathes. Before using the tools, care should be taken to ensure that the unused connections are closed with the screw in the set and that sealing is ensured. Cooling hose sets for lathe tools can be used in the pressure range of ACHS ... 10 bar to max 275 bar.

Примечание: Предлагается 3 типа комплектов трубок для подвода СОЖ. Они могут использоваться на всех токарных станках оснащенных системой подвода СОЖ. Перед началом работ необходимо закрыть неиспользуемые соединения винтом из набора и обеспечить герметичность системы подвода СОЖ. Комплекты охлаждающих трубок, для токарных инструментов, могут использоваться в диапазоне давлений АСНС ..... от 10 бар до 275 бар.

Set İçindeki Parçalar Parts In The Set Запчасти в Наборе				Uzunluk / Length Code / Длина		
				Set Kodu: Set Code: Код Набора: ACHS-1-250	Set Kodu: Set Code: Код Набора: ACHS-2-250	Set Kodu: Set Code: Код Набора: ACHS-3-250
	Resim Picture Рисунок	Takım Kodu Set Code Код Набора	Ürün Açıklaması Product Description Описание товара			
1		AMP-01	M10 Bağlantı Elemanı M10 Fastener Застежка M10	1x	-	-
2		AMP-02	G 1/8" Çift Bağlantı Elemanı G 1/8" Double Fastener G 1/8" двойная застежка	2x	1x	-
3		AMP-03	G 1/8" Açılı Bağlantısı G 1/8" Angle Connection G 1/8" угловое соединение	-	1x	2x
4		AMP-04	M10" Açılı Bağlantısı M10" Angle Connection M10" угловое соединение	-	1x	1x
5		AMP-05	G1/4"-G1/8" Kılcalma Parçası G1/4"-G1/8" Capillary Piece G1/4"-G1/8" Капиллярная часть	-	1x	1x
6		AG-01	Bakır Conta Copper Gasket Медная прокладка	2x	3x	4x
7		2705-G1/8-5.5	G1/8" Sızdırmaz Civata G1/8" Sealing Bolt G1/8" Уплотнительный болт	1x	1x	1x
8		AH-1-250	Hortum Hose Трубка	1x	-	-
9		AH-2-250	Hortum Hose Трубка	-	1x	-
10		AH-3-250	Hortum Hose Трубка	-	-	1x

# C-SİSTEM

C-SİSTEM DIŞ TORNA KATERLERİ  
C-SYSTEM EXTERNAL TURNING TOOLHOLDERS  
C-ТИП ДЕРЖАВКИ ДЛЯ НАРУЖНОГО ТОЧЕНИЯ

*konusulan*  
*the spoken kalite...*  
*quality...*



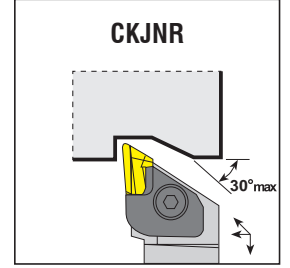
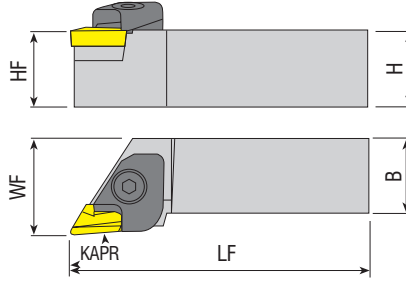

**Takım Kodu**  
**Ordering Code**  
Код для заказа

Stok  
Stock  
Наличие

Takım Ölçüleri (mm)  
Dimension (mm)  
Размеры (мм)

Kesici Uç  
Insert  
Пластина

Baskı Pabuçu  
Wedge Clamp  
Прижим

Pabuç Vidası  
Clamp Screw  
Зажимной винт

Altlık  
Shim  
Опорная пластина

Altlık Vidası  
Shim Screw  
Винт опорной пластины

Yay  
Spring  
Пружина

Pul  
Stamp  
Шайба

Anahtar  
Allen Key  
Ключ

Yedek Parçaları / Spare Parts / Запасные части

R L

HF=H

B

LF

WF

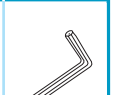

**CKJNR/L 2020 K16**

**2525 M16**

**3232 P16**

**4040 S16**

● ●

● ●

20

20

125

27.5

● ●

25

25

150

31.5

● ●

32

32

170

40

● ●

40

40

250

50

**KNUX 1604..**

ACK-01-R

ACK-02-L

AKV-06-M16x20

AKS-16-R

AKS-16-L

AAV-01-M3x10

AKY-02

ABPL-01

AAL-05-4

R: Sağ / Right / Правый L: Sol / Left / Левый

● Stokta / In Stock / В наличии ○ Stokta Yok / Non Stock Item / Нет в наличии

Sipariş Örneği/Ordering Example/Образец заказа

1 ad./pcs./шт. CKJNR 2020 K16



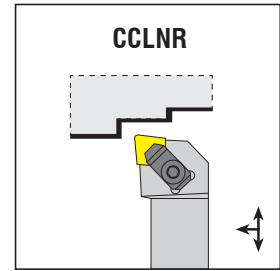
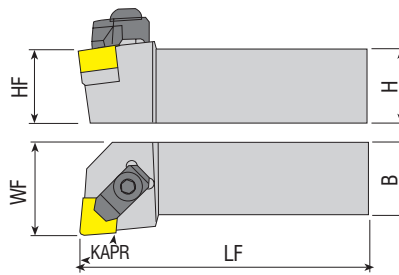
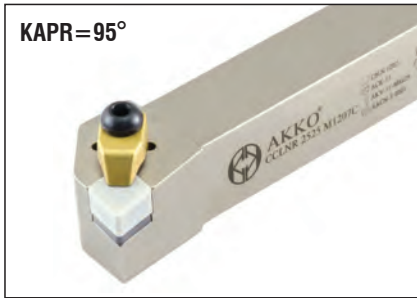

**Takım Kodu**  
**Ordering Code**  
Код для заказа

Stok Stock Наличие	Takım Ölçüleri (mm) Dimension (mm) Размеры (мм)						Kesici Uç Insert Пластина	Yedek Parçaları / Spare Parts / Запасные части						
	R	L	HF=H	B	LF	WF		Baskı Pabucu Wedge Clamp Прижим	Pabuç Vidası Clamp Screw Зажимной винт	Altlık Shim Опорная пластина	Altlık Vidası Shim Screw Винт опорной пластины	Sekman Ring Кольцо	Anahtar Allen Key Ключ	
			25	25	150	32								
	●	●	25	25	150	32	<b>CN.N 1207..</b>	ACK-13	AKV-11-M8x29	AACN-3-0001	AAV-02-M5x12	ACS-01	AAL-05-4	
	●	●	32	32	170	40								
	●	●	25	25	150	32	<b>CN.N 1607..</b>	ACK-13	AKV-11-M8x29	AACN-3-0002	AAV-05-M6x15	ACS-01	AAL-05-4	

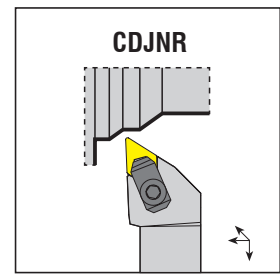
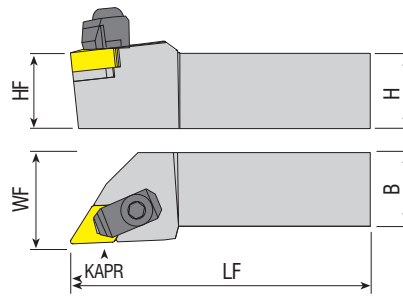

**Takım Kodu**  
**Ordering Code**  
Код для заказа

Stok Stock Наличие	Takım Ölçüleri (mm) Dimension (mm) Размеры (мм)						Kesici Uç Insert Пластина	Yedek Parçaları / Spare Parts / Запасные части						
	R	L	HF=H	B	LF	WF		Baskı Pabucu Wedge Clamp Прижим	Pabuç Vidası Clamp Screw Зажимной винт	Altlık Shim Опорная пластина	Altlık Vidası Shim Screw Винт опорной пластины	Sekman Ring Кольцо	Anahtar Allen Key Ключ	
			25	25	150	32								
	●	●	25	25	150	32	<b>DN.N 1107..</b>	ACK-22	AKV-11-M8x29	AADN-2-0001	AAV-04-M5x12	ACS-01	AAL-05-4	
	●	●	25	25	150	32								
	●	●	32	32	170	40	<b>DN.N 1507..</b>	ACK-13	AKV-11-M8x29	AADN-3-0001	AAV-02-M5x12	ACS-01	AAL-05-4	

R: Sağ / Right / Правый L: Sol / Left / Левый

● Stokta / In Stock / В наличии ○ Stokta Yok / Non Stock Item / Нет в наличии

Sipariş Örneği/Ordering Example/Образец заказа

1 ad./pcs./шт. CCLNR 2525 M1207C



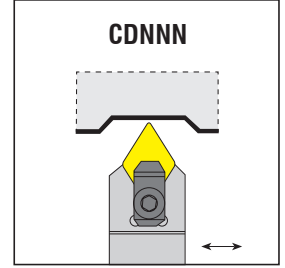
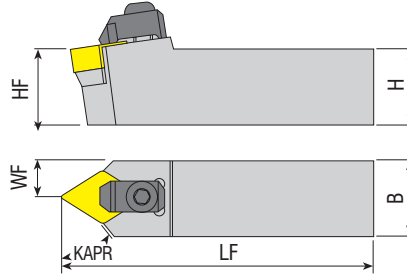

Takım Kodu Ordering Code Код для заказа	Stok Stock Наличие	Takım Ölçüleri (mm) Dimension (mm) Размеры (мм)				Kesici Uç Insert Пластина	Yedek Parçaları / Spare Parts / Запасные части					
		HF=H	B	LF	WF		Baskı Pabuçu Wedge Clamp Прижим	Pabuç Vidası Clamp Screw Зажимной винт	Altlık Shim Опорная пластина	Altlık Vidası Shim Screw Винт опорной пластины	Sekman Ring Кольцо	Anahtar Allen Key Ключ
CDNNN 2525 M1107C	●	25	25	150	12.5	DN.N 1107..	ACK-22	AKV-11-M8x29	AADN-2-0001	AAV-04-M5x12	ACS-01	AAL-05-4

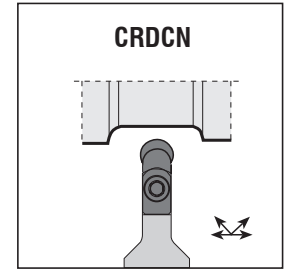
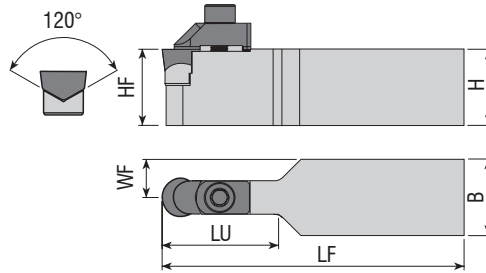

Takım Kodu Ordering Code Код для заказа	Stok Stock Наличие	Takım Ölçüleri (mm) Dimension (mm) Размеры (мм)					Kesici Uç Insert Пластина	Yedek Parçaları / Spare Parts / Запасные части				
		HF=H	B	LF	LU	WF		Baskı Pabuçu Wedge Clamp Прижим	Pabuç Vidası Clamp Screw Зажимной винт	Altlık Shim Опорная пластина	Altlık Vidası Shim Screw Винт опорной пластины	Anahtar Allen Key Ключ
CRDCN 2525 M06CV	●	25	25	150	19	12.5	RCGX 0606..	ACK-27	2525-M3X14	AARC-3-0001	3007-M2.2X5	AAL-02-2.5
3225 P06CV	●	32	25	170	19	12.5						
4040 S06CV	●	40	40	250	19	20						
2525 M09CV	●	25	25	150	29	12.5	RCGX 0907..	ACK-28	2504-M5X16	AARC-3-0002	3008-M2.5x6	AAL-05-4
3225 P09CV	●	32	25	170	29	12.5						
4040 S09CV	●	40	40	250	29	20						
2525 M12CV	●	25	25	150	38	12.5	RCGX 1207..	ACK-29	2505-M6X20	AARC-3-0003	3008-M2.5x6	AAL-07-5
3225 P12CV	●	32	25	170	38	12.5						
4040 S12CV	●	40	40	250	38	20						

R: Sağ / Right / Правый L: Sol / Left / Левый  
● Stokta / In Stock / В наличии ○ Stokta Yok / Non Stock Item / Нет в наличии

Sipariş Örneği/Ordering Example/Образец заказа  
1 ad./pcs./шт. CDNNN 2525 M1107C

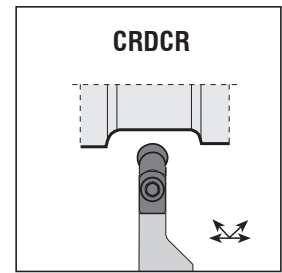
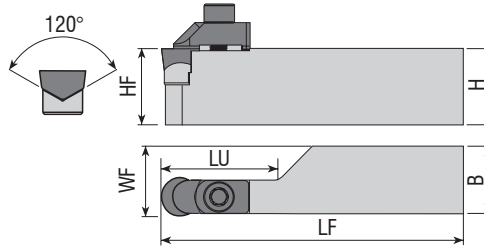

Takım Kodu Ordering Code Код для заказа	Stok Stock Наличие		Takım Ölçüleri (mm) Dimension (mm) Размеры (мм)					Kesici Uç Insert Пластина	Baskı Pabucu Wedge Clamp Прижим	Pabuç Vidası Clamp Screw Зажимной винт	Altlık Shim Опорная пластина	Altlık Vidası Shim Screw Винт опорной пластины	Anahtar Allen Key Ключ
	R	L	HF=H	B	LF	LU	WF						
CRDCR/L 3225 P06CV	●	●	32	25	170	19.4	25.6	RCGX 0606..	ACK-27	2525-M3X14	AARC-3-0001	3007-M2.2X5	AAL-02-2.5
3225 P09CV	●	●	32	25	170	29	25.8	RCGX 0907..	ACK-28	2504-M5X16	AARC-3-0002	3008-M2.5x6	AAL-05-4
3225 P12CV	●	●	32	25	170	38.5	25.9	RCGX 1207..	ACK-29	2505-M6X20	AARC-3-0003	3008-M2.5x6	AAL-07-5

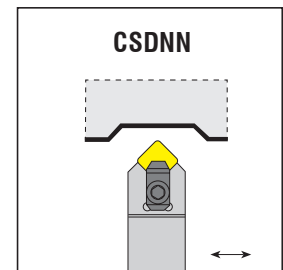
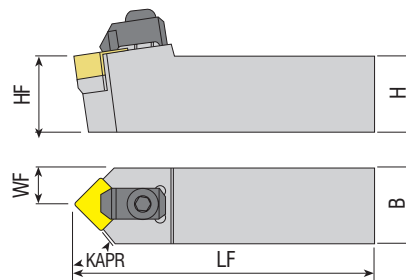

Takım Kodu Ordering Code Код для заказа	Stok Stock Наличие		Takım Ölçüleri (mm) Dimension (mm) Размеры (мм)				Kesici Uç Insert Пластина	Baskı Pabucu Wedge Clamp Прижим	Pabuç Vidası Clamp Screw Зажимной винт	Altlık Shim Опорная пластина	Altlık Vidası Shim Screw Винт опорной пластины	Sekman Ring Кольцо	Anahtar Allen Key Ключ
	HF=H	B	LF	WF									
CSDNN 2525 M1207C	●	●	25	25	150	12.5	SN.N 1207..	ACK-13	AKV-11-M8x29	AASN-3-0004	AAV-02-M5x12	ACS-01	AAL-05-4
3232 P1207C	●	●	32	32	170	16							

R: Sağ / Right / Правый L: Sol / Left / Левый  
● Stokta / In Stock / В наличии ○ Stokta Yok / Non Stock Item / Нет в наличии

Sipariş Örneği/Ordering Example/Образец заказа  
1 ad./pcs./шт. CRDCR 3225 P06CV

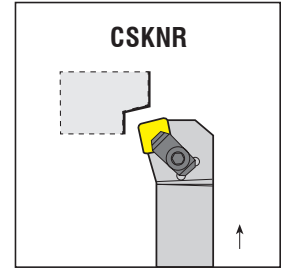
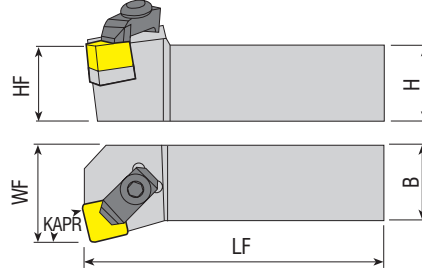
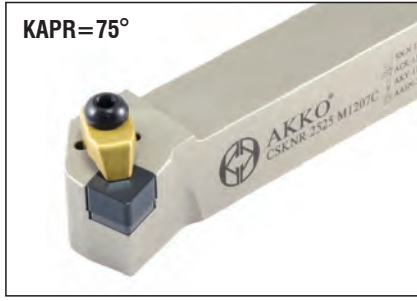

**Takım Kodu**  
**Ordering Code**  
 Код для заказа

Stok Stock Наличие	Takım Ölçüleri (mm) Dimension (mm) Размеры (мм)					Kesici Uç Insert Пластина	Yedek Parçaları / Spare Parts / Запасные части						
	R	L	HF=H	B	LF		WF	Baskı Pabucu Wedge Clamp Прижим	Pabuç Vidası Clamp Screw Зажимной винт	Altık Shim Опорная пластина	Altık Vidası Shim Screw Винт опорной пластины	Sekman Ring Кольцо	Anahtar Allen Key Ключ
CSKNR/L 2525 M1207C	●	●	25	25	150	32	SN.N 1207..	ACK-13	AKV-11-M8x29	AASN-3-0004	AAV-02-M5x12	ACS-01	AAL-05-4
3232 P1207C	●	●	32	32	170	40							

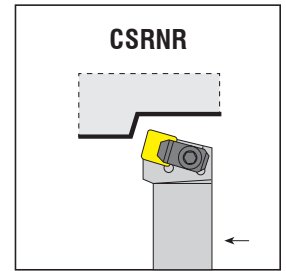
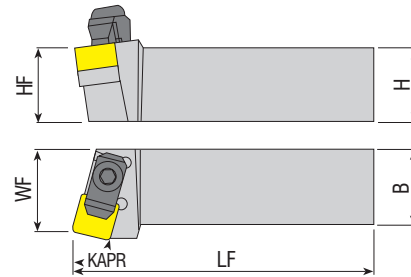

**Takım Kodu**  
**Ordering Code**  
 Код для заказа

Stok Stock Наличие	Takım Ölçüleri (mm) Dimension (mm) Размеры (мм)					Kesici Uç Insert Пластина	Yedek Parçaları / Spare Parts / Запасные части						
	R	L	HF=H	B	LF		WF	Baskı Pabucu Wedge Clamp Прижим	Pabuç Vidası Clamp Screw Зажимной винт	Altık Shim Опорная пластина	Altık Vidası Shim Screw Винт опорной пластины	Sekman Ring Кольцо	Anahtar Allen Key Ключ
CSRNR/L 2525 M1207C	●	●	25	25	150	32	SN.N 1207..	ACK-13	AKV-11-M8x29	AASN-3-0004	AAV-02-M5x12	ACS-01	AAL-05-4
3232 P1207C	●	●	32	32	170	40							

R: Sağ / Right / Правый L: Sol / Left / Левый

● Stokta / In Stock / В наличии ○ Stokta Yok / Non Stock Item / Нет в наличии

Sipariş Örneği/Ordering Example/Образец заказа

1 ad./pcs./шт. CSKNR 2525 M1207C

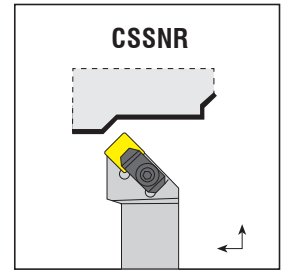
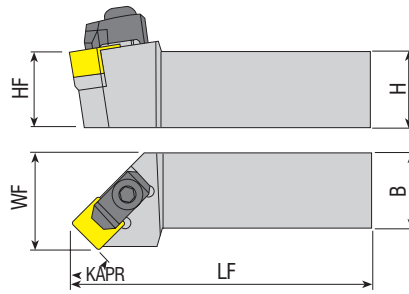

Takım Kodu Ordering Code Код для заказа	Stok Stock Наличие		Takım Ölçüleri (mm) Dimension (mm) Размеры (мм)				Kesici Uç Insert Пластина	Yedek Parçaları / Spare Parts / Запасные части					
	R	L	HF=H	B	LF	WF		Baskı Pabucu Wedge Clamp Прижим	Pabuç Vidası Clamp Screw Зажимной винт	Altlık Shim Опорная пластина	Altlık Vidası Shim Screw Винт опорной пластины	Sekman Ring Кольцо	Anahtar Allen Key Ключ
	●	○											
CSSNR/L 2525 M1207C	●	●	25	25	150	32	SN.N 1207..	ACK-13	AKV-11-M8x29	AASN-3-0004	AAV-02-M5x12	ACS-01	AAL-05-4
3232 P1207C	●	●	32	32	170	40							

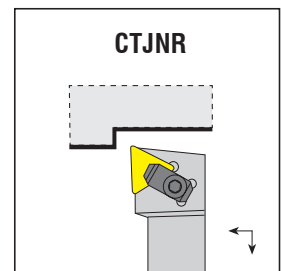
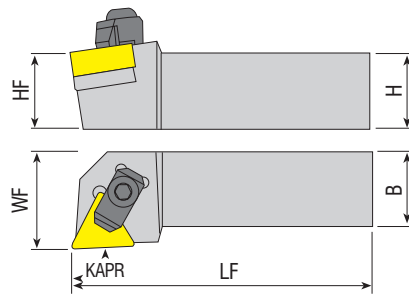

Takım Kodu Ordering Code Код для заказа	Stok Stock Наличие		Takım Ölçüleri (mm) Dimension (mm) Размеры (мм)				Kesici Uç Insert Пластина	Yedek Parçaları / Spare Parts / Запасные части					
	R	L	HF=H	B	LF	WF		Baskı Pabucu Wedge Clamp Прижим	Pabuç Vidası Clamp Screw Зажимной винт	Altlık Shim Опорная пластина	Altlık Vidası Shim Screw Винт опорной пластины	Sekman Ring Кольцо	Anahtar Allen Key Ключ
	●	○											
CTJNR/L 2525 M1607C	●	●	25	25	150	32	TN.N 1607..	ACK-14	AKV-11-M8x29	AATN-2-0002	AAV-03-M5x12	ACS-01	AAL-05-4
3232 P1607C	○	○	32	32	170	40							

R: Sağ / Right / Правый L: Sol / Left / Левый  
● Stokta / In Stock / В наличии ○ Stokta Yok / Non Stock Item / Нет в наличии

Sipariş Örneği/Ordering Example/Образец заказа  
1 ad./pcs./шт. CSSNR 2525 M1207C



*konusulan  
the spoken kalite...  
quality...*

## S-SİSTEM

**S-SİSTEM DIŞ TORNA KATERLERİ**  
S-SYSTEM EXTERNAL TURNING TOOLHOLDERS  
S-ТИП ДЕРЖАВКИ ДЛЯ НАРУЖНОГО ТОЧЕНИЯ



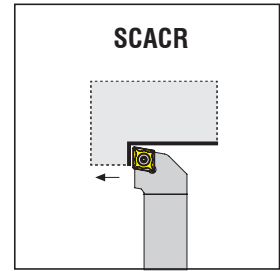
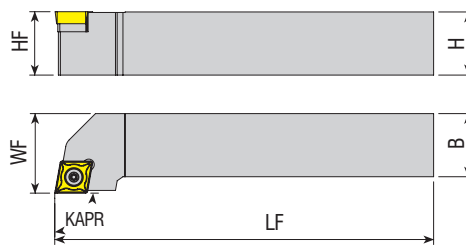
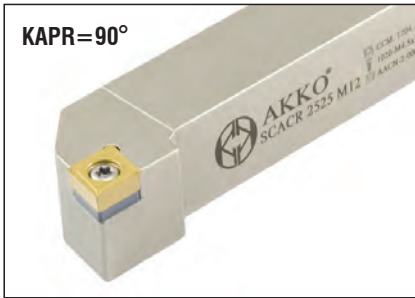

**Takım Kodu**  
**Ordering Code**  
Код для заказа

Stok  
Stock  
Наличие

Takım Ölçüleri (mm)  
Dimension (mm)  
Размеры (мм)

Kesici Uç  
Insert  
Пластина

Yedek Parçaları / Spare Parts / Запасные части

Sıkma Vidası  
Screw  
Зажимной винт

Altlık  
Shim  
Опорная пластина

Altlık Vidası  
Shim Screw  
Винт опорной пластины

Tork Anahtar  
Torx Key  
Торх Ключ

R L

HF=H

B

LF

WF



SCACR/L 0808 E06	●	●	08	08	70	10
1010 E06	●	●	10	10	70	12
1212 F09	●	●	12	12	80	16
1616 H09	●	●	16	16	100	20
2020 K09	●	●	20	20	125	25
2020 K12	●	●	20	20	125	25
2525 M12	●	●	25	25	150	32

CCM. 0602..

4008-M2.5x6

-

-

80-T08

CC.T 09T3..

4015-M3.5x11

-

-

4015-M3.5x14

AACN-2-0001

AAV-06-M3.5x11

80-T15

CC.T 1204..

1020-M4.5x16

AACN-2-0003

AAV-07-M4.5x13

80-T20

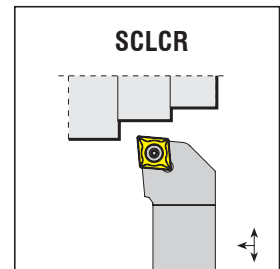
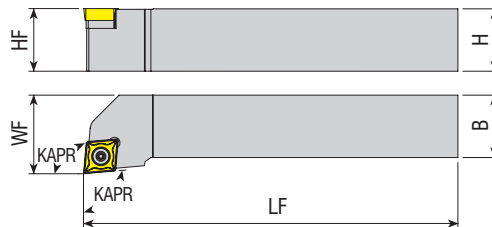
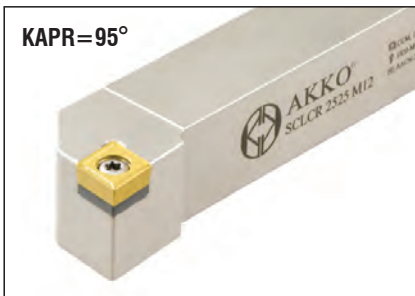

**Takım Kodu**  
**Ordering Code**  
Код для заказа

Stok  
Stock  
Наличие

Takım Ölçüleri (mm)  
Dimension (mm)  
Размеры (мм)

Kesici Uç  
Insert  
Пластина

Yedek Parçaları / Spare Parts / Запасные части

Sıkma Vidası  
Screw  
Зажимной винт

Altlık  
Shim  
Опорная пластина

Altlık Vidası  
Shim Screw  
Винт опорной пластины

Tork Anahtar  
Torx Key  
Торх Ключ

R L

HF=H

B

LF

WF



SCLCR/L 0808 E06	●	●	08	08	70	10
1010 E06	●	○	10	10	70	12
1212 F06	●	●	12	12	80	16
1010 E09	●	●	10	10	70	12
1212 F09	●	●	12	12	80	16
1616 H09	●	●	16	16	100	20
2020 K09	●	●	20	20	125	25
2525 M09	●	●	25	25	150	32
1616 H12	●	○	16	16	100	20
2020 K12	●	●	20	20	125	25
2525 M12	●	●	25	25	150	32

CCM. 0602..

4008-M2.5x6

-

-

80-T08

CC.T 09T3..

4015-M3x9

-

-

4015-M3.5x11

-

-

4015-M3.5x14

AACN-2-0001

AAV-06-M3.5x11

80-T15

CC.T 1204..

1020-M5x11

-

-

1020-M4.5x16

AACN-2-0003

AAV-07-M4.5x13

80-T20

R: Sağ / Right / Правый L: Sol / Left / Левый

● Stokta / In Stock / В наличии ○ Stokta Yok / Non Stock Item / Нет в наличии

Sipariş Örneği/Ordering Example/Образец заказа

1 ad./pcs./шт. SCACR 0808 E06

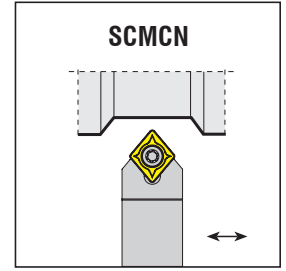
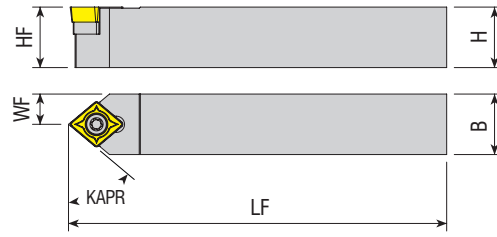
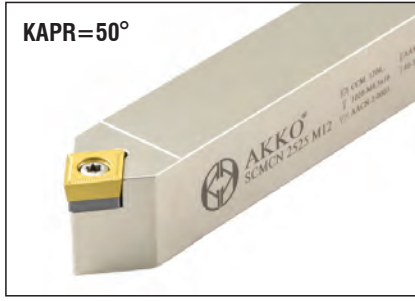

**Takım Kodu**  
**Ordering Code**  
Код для заказа

Stok  
Stock  
Наличие

Takım Ölçüleri (mm)  
Dimension (mm)  
Размеры (мм)

Kesici Uç  
Insert  
Пластина

Yedek Parçaları / Spare Parts / Запасные части

Sıkma Vidası  
Screw  
Зажимной винт

Altlık  
Shim  
Опорная пластина

Altlık Vidası  
Shim Screw  
Винт опорной пластины

Tork Anahtar  
Torx Key  
Торх Ключ

HF=H	B	LF	WF
------	---	----	----



SCMCN 0808 E06	●	08	08	70	04
1010 E06	●	10	10	70	05
1212 F06	●	12	12	80	06
1212 F09	●	12	12	80	06
1616 H09	●	16	16	100	08
2020 K12	●	20	20	125	10
2525 M12	●	25	25	150	12.5

CCM. 0602..

4008-M2.5x6

-

-

80-T08

CC.T 09T3..

4015-M3.5x11

-

-

80-T15

CC.T 1204..

1020-M4.5x16

AACN-2-0001

AAV-06-M3.5x11

80-T20

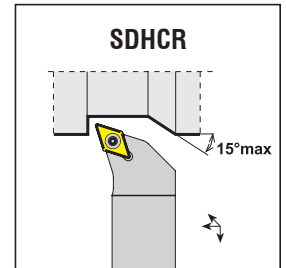
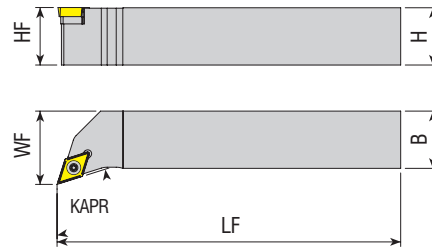
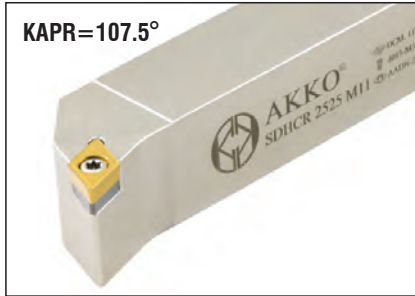

**Takım Kodu**  
**Ordering Code**  
Код для заказа

Stok  
Stock  
Наличие

Takım Ölçüleri (mm)  
Dimension (mm)  
Размеры (мм)

Kesici Uç  
Insert  
Пластина

Yedek Parçaları / Spare Parts / Запасные части

Sıkma Vidası  
Screw  
Зажимной винт

Altlık  
Shim  
Опорная пластина

Altlık Vidası  
Shim Screw  
Винт опорной пластины

Tork Anahtar  
Torx Key  
Торх Ключ

R	L	HF=H	B	LF	WF
---	---	------	---	----	----

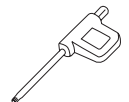

SDHCR/L 0808 E07	●	●	08	08	70	11
1010 E07	●	●	10	10	70	12
1212 F07	●	●	12	12	80	16
1616 H07	●	●	16	16	100	20
1616 H11	●	●	16	16	100	20
2020 K11	●	●	20	20	125	25
2525 M11	●	●	25	25	150	32
3232 P11	●	●	32	32	170	40

DC.T 0702..

4008-M2.5x6

-

-

80-T08

DC.T 11T3..

4015-M3.5x14

AADN-2-0001

AAV-06-M3.5x11

80-T15

R: Sağ / Right / Правый L: Sol / Left / Левый

● Stokta / In Stock / В наличии ○ Stokta Yok / Non Stock Item / Нет в наличии

Sipariş Örneği/Ordering Example/Образец заказа

1 ad./pcs./шт. SCMCN 0808 E06

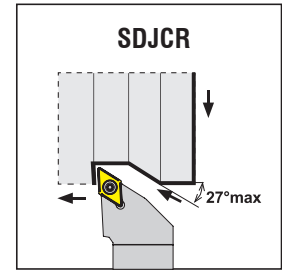
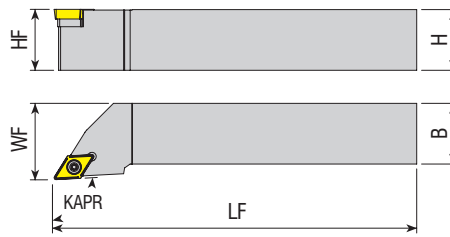
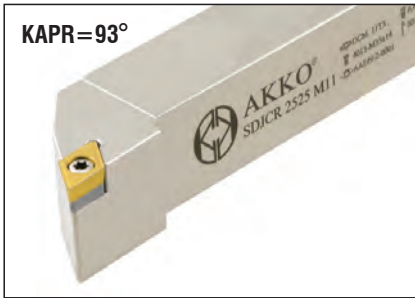

Takım Kodu Ordering Code Код для заказа	Stok Stock Наличие		Takım Ölçüleri (mm) Dimension (mm) Размеры (мм)				Kesici Uç Insert Пластина	Yedek Parçaları / Spare Parts / Запасные части			
	R	L	HF=H	B	LF	WF		Sıkma Vidası Screw Зажимной винт	Altılık Shim Опорная пластина	Altılık Vidası Shim Screw Винт опорной пластины	Tork Anahtar Torx Key Торх Ключ
SDJCR/L 0808 E07	●	●	08	08	70	10	DC.T 0702..	4008-M2.5x6	-	-	80-T08
1010 E07	●	●	10	10	70	12					
1212 F07	●	●	12	12	80	16					
1616 H07	●	●	16	16	100	20					
1616 H11	●	●	16	16	100	20	DC.T 11T3..	4015-M3.5x14	AADN-2-0001	AAV-06-M3.5x11	80-T15
2020 K11	●	●	20	20	125	25					
2525 M11	●	●	25	25	150	32					
3232 P11	●	●	32	32	170	40					

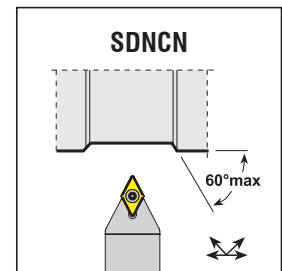
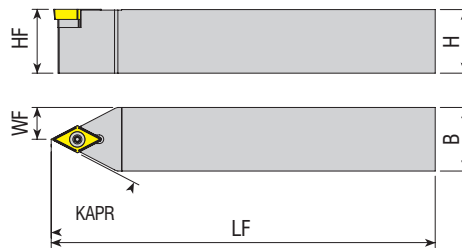
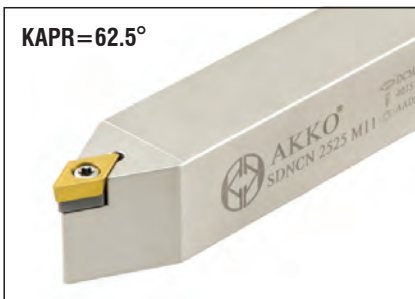

Takım Kodu Ordering Code Код для заказа	Stok Stock Наличие		Takım Ölçüleri (mm) Dimension (mm) Размеры (мм)				Kesici Uç Insert Пластина	Yedek Parçaları / Spare Parts / Запасные части			
			HF=H	B	LF	WF		Sıkma Vidası Screw Зажимной винт	Altılık Shim Опорная пластина	Altılık Vidası Shim Screw Винт опорной пластины	Tork Anahtar Torx Key Торх Ключ
SDNCN 0808 E07	●		08	08	70	4	DC.T 0702..	4008-M2.5x6	-	-	80-T08
1010 E07	●		10	10	70	5					
1212 F07	●		12	12	80	6					
1616 H07	●		16	16	100	8					
1616 H11	●		16	16	100	8	DC.T 11T3..	4015-M3.5x14	AADN-2-0001	AAV-06-M3.5x11	80-T15
2020 K11	●		20	20	125	10					
2525 M11	●		25	25	150	12.5					
3232 P11	●		32	32	170	16					

R: Sağ / Right / Правый L: Sol / Left / Левый  
● Stokta / In Stock / В наличии ○ Stokta Yok / Non Stock Item / Нет в наличии

Sipariş Örneği/Ordering Example/Образец заказа  
1 ad./pcs./шт. SDJCR 0808 E07

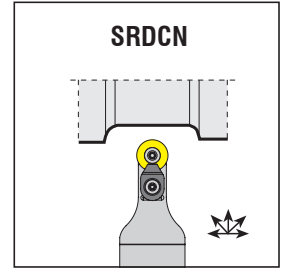
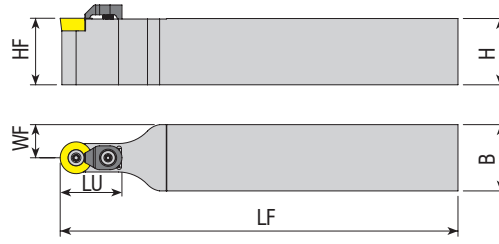

**Takım Kodu**  
**Ordering Code**  
 Код для заказа

 Stok  
 Stock  
 Наличие

 Takım Ölçüleri (mm)  
 Dimension (mm)  
 Размеры (мм)

 Kesici Uç  
 Insert  
 Пластина

Yedek Parçaları / Spare Parts / Запасные части

 Sıkma Vidası  
 Screw  
 Зажимной винт

 Altlık  
 Shim  
 Опорная пластина

 Altlık Vidası  
 Shim Screw  
 Винт опорной пластины

 Baskı Parçası  
 Wedge Clamp  
 Прижим

 Baskı Vidası  
 Clamp Screw  
 Зажимной винт

 Tork Anahtar  
 Torx Key  
 Торк Ключ

HF=H

B

LF

LU

WF



SRDCN 1616 H06

●

16

16

100

15

8

2020 K06

●

20

20

125

17

10

RC.T 0602..

3008-M2.5x6

-

-

-

-

2525 M06

●

25

25

150

17

12.5

1616 H08C

●

16

16

100

15

8

RC.T 0803..

3008-M3x8

-

-

-

-

80-T08

2020 K08C

●

20

20

125

20

10

2525 M08C

●

25

25

150

20

12.5

1616 H10C

●

16

16

100

20

8

RC.T 10T3..

4015-M3.5x11

-

-

ACK-15

4015-M3.5x11

2020 K10C

●

20

20

125

20

10

2525 M10C

●

25

25

150

20

12.5

3232 P10C

●

32

32

170

20

16

2020 K12C

●

20

20

125

22

10

RC.T 1204..

4015-M3.5x11

-

-

ACK-05

4015-M4x11

80-T15

2525 M12C

●

25

25

150

22

12.5

3232 P12C

●

32

32

170

22

16

2525 M16C

●

25

25

150

32

12.5

RC.T 1605..

1020-M5x11

-

-

ACK-05

4015-M4x11

3232 P16C

●

32

32

170

35

16

2525 M20C

●

25

25

150

32

12.5

RC.T 2006..

1420-M6x16

-

-

ACK-09

AAV-05-M6x15

80-T20

3232 P20C

●

32

32

170

40

16

3232 P25C

●

32

32

170

40

16

RC.T 2507..

1520-M6x16

-

-

ACK-09

AAV-05-M6x15

80-T20

3232 P32C

●

32

32

170

45

16

RC.T 3209..

1904-M8x1x20

-

-

ACK-09

AAV-05-M6x15

80-T20

AAL-05-4

R: Sağ / Right / Правый L: Sol / Left / Левый

● Stokta / In Stock / В наличии ○ Stokta Yok / Non Stock Item / Нет в наличии

Sipariş Örneği/Ordering Example/Образец заказа

1 ad./pcs./шт. SRDCN 1616 H06



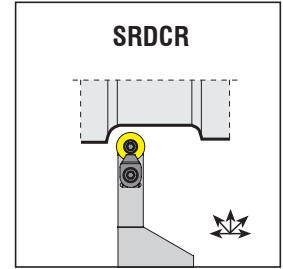
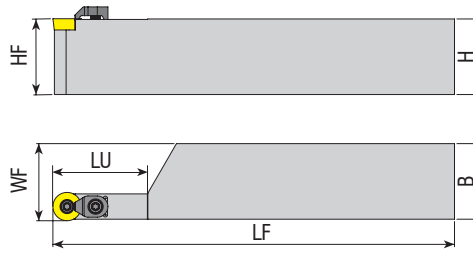

**Takım Kodu**  
**Ordering Code**  
*Код для заказа*

Takım Kodu Ordering Code <i>Код для заказа</i>	Stok Stock <i>Наличие</i>		Takım Ölçüleri (mm) Dimension (mm) <i>Размеры (мм)</i>					Kesici Uç Insert <i>Пластина</i>	Yedek Parçaları / Spare Parts / <i>Запасные части</i>					
	R	L	HF=H	B	LF	LU	WF		Sıkma Vidası Screw <i>Зажимной винт</i>	Altlık Shim <i>Опорная пластина</i>	Altlık Vidası Shim Screw <i>Винт опорной пластины</i>	Baskı Parçası Wedge Clamp <i>Прижим</i>	Baskı Vidası Clamp Screw <i>Зажимной винт</i>	Tork Anahtar Torx Key <i>Торх Ключ</i>
SRDCR/L 3232 T06	●	●	32	32	300	20	32.35			-	-	-	-	80-T08
3232 P12C	●	●	32	32	170	40	32.65			-	-	ACK-05	4015-M4x11	80-T15

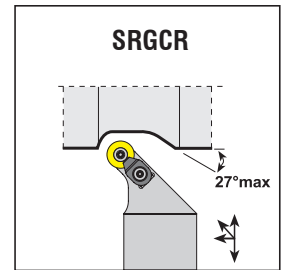
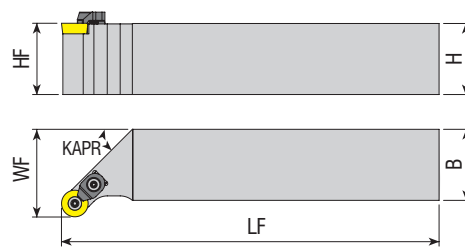

**Takım Kodu**  
**Ordering Code**  
*Код для заказа*

Takım Kodu Ordering Code <i>Код для заказа</i>	Stok Stock <i>Наличие</i>		Takım Ölçüleri (mm) Dimension (mm) <i>Размеры (мм)</i>					Kesici Uç Insert <i>Пластина</i>	Yedek Parçaları / Spare Parts / <i>Запасные части</i>					
	R	L	HF=H	B	LF	WF	Sıkma Vidası Screw <i>Зажимной винт</i>		Altlık Shim <i>Опорная пластина</i>	Altlık Vidası Shim Screw <i>Винт опорной пластины</i>	Baskı Parçası Wedge Clamp <i>Прижим</i>	Baskı Vidası Clamp Screw <i>Зажимной винт</i>	Tork Anahtar Torx Key <i>Торх Ключ</i>	
SRGCR/L 1616 H06	●	●	16	16	100	20	RC.T 0602..		-	-	-	-	80-T08	
2020 K06	●	●	20	20	125	25								
1616 H08C	●	●	16	16	100	20	RC.T 0803..		-	-	ACK-15	4015-M3.5x11	80-T15	
2020 K08C	●	●	20	20	125	25								
2525 M08C	●	●	25	25	150	32	RC.T 10T3..		-	-	ACK-05	4015-M4x11		
1616 H10C	●	●	16	16	100	20								
2020 K10C	●	●	20	20	125	25								
2525 M10C	●	●	25	25	150	32								
3232 P10C	●	●	32	32	170	40	RC.T 1204..		-	ACK-05	4015-M4x11			
2020 K12C	●	●	20	20	125	25								
2525 M12C	●	●	25	25	150	32								
3232 P12C	●	●	32	32	170	40								

R: Sağ / Right / Правый L: Sol / Left / Левый  
● Stokta / In Stock / В наличии ○ Stokta Yok / Non Stock Item / Нет в наличии

Sipariş Örneği/Ordering Example/Образец заказа  
1 ad./pcs./шт. SRDCR 3232 T06

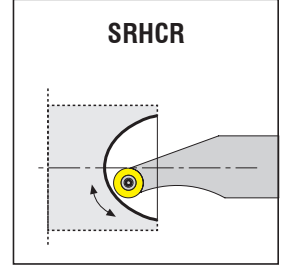
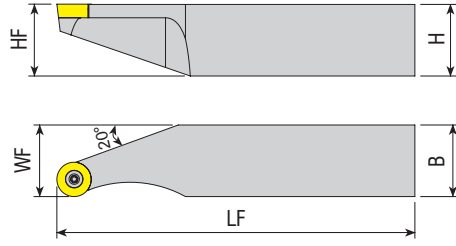

**Takım Kodu**  
**Ordering Code**  
Код для заказа

Stok Stock Наличие	Takım Ölçüleri (mm) Dimension (mm) Размеры (мм)						Kesici Uç Insert Пластина	Yedek Parçaları / Spare Parts / Запасные части				Tork Anahtar Torx Key Торх Ключ
	R	L	HF=H	B	LF	WF		Sikma Vidası Screw Зажимной винт	Altlık Shim Опорная пластина	Altlık Vidası Shim Screw Винт опорной пластины		
SRHCR/L 2525 K06	●	○	25	25	125	25	32.5	RC.T 0602..	3008-M2.5x6	-	-	80-T08
2525 K08	●	●	25	25	125	25	32.5	RC.T 0803..	3008-M3x8	-	-	80-T08
2525 K10	●	●	25	25	125	25	36	RC.T 10T3..	4015-M3.5x11	-	-	80-T15
2525 K12	●	●	25	25	125	25	40	RC.T 1204..	-	-	-	80-T15
2525 K16	●	●	25	25	125	25	47.5	RC.T 1606..	1020-M5x11	-	-	80-T20

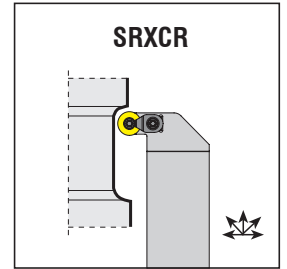
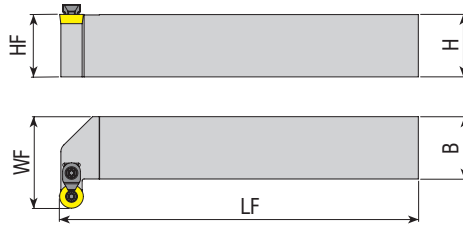

**Takım Kodu**  
**Ordering Code**  
Код для заказа

Stok Stock Наличие	Takım Ölçüleri (mm) Dimension (mm) Размеры (мм)						Kesici Uç Insert Пластина	Sikma Vidası Screw Зажимной винт	Altılık Shim Опорная пластина	Altılık Vidası Shim Screw Винт опорной пластины	Baskı Parçası Wedge Clamp Прижим	Baskı Vidası Clamp Screw Зажимной винт	Tork Anahtar Torx Key Торх Ключ
	R	L	HF=H	B	LF	WF							
SRXCR/L 3232 X08C	●	●	32	32	220	47	RC.T 0803..	3008-M3x8	-	-	ACK-15	4015-M3.5x11	80-T08
3232 X10C	●	●	32	32	220	47	RC.T 10T3..	4015-M3.5x11	-	-	ACK-15	4015-M3.5x11	80-T15
3232 X12C	●	●	32	32	220	47	RC.T 1204..	-	-	ACK-05	4015-M4x11	-	80-T15

R: Sağ / Right / Правый L: Sol / Left / Левый

● Stokta / In Stock / В наличии ○ Stokta Yok / Non Stock Item / Нет в наличии

Sipariş Örneği/Ordering Example/Образец заказа

1 ad./pcs./шт. SRHCR 2525 K06

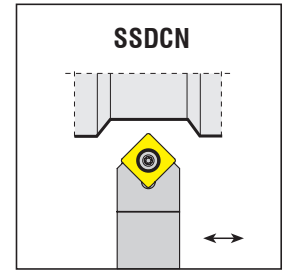
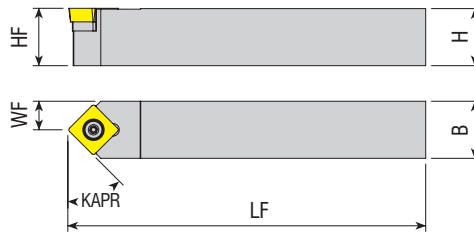
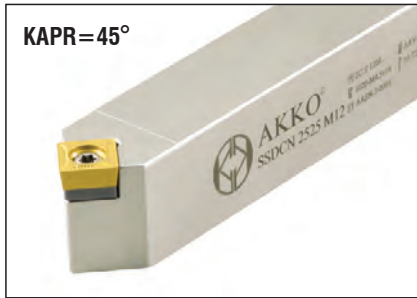

Yedek Parçaları / Spare Parts / Залпасные части

Takım Kodu Ordering Code Код для заказа	Stok Stock Наличие		Takım Ölçüleri (mm) Dimension (mm) Размеры (мм)				Kesici Uç Insert Пластина	Sıkma Vidası Screw Зажимной винт	Altlık Shim Опорная пластина	Altlık Vidası Shim Screw Винт опорной пластины	Tork Anahtar Torx Key Торх Ключ
	R	L	HF=H	B	LF	WF					
SSDCN 1212 F09	●		12	12	80	6	SC.T 09T3..	4015-M3.5x11	-	-	80-T15
1616 H09	●		16	16	100	8		4015-M3.5x14	AASN-2-0001	AAV-06-M3.5x11	
2020 K09	●		20	20	125	10		4020-M4.5x12		AAV-10-M4.5x8	
1616 H12	●		16	16	100	8	SC.T 1204..	1020-M4.5x16	AASN-2-0004	AAV-07-M4.5x13	80-T20
2020 K12	●		20	20	125	10					
2525 M12	●		25	25	150	12.5					

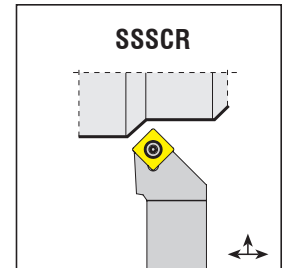
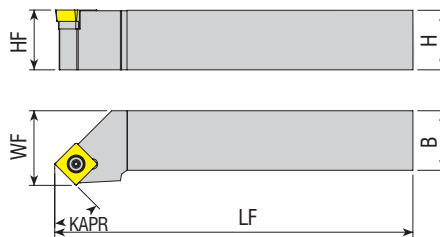
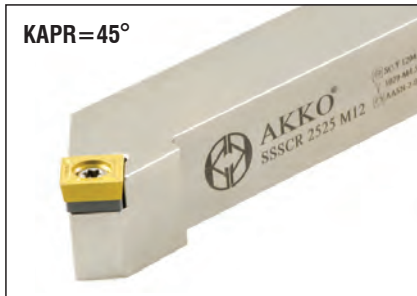

Yedek Parçaları / Spare Parts / Залпасные части

Takım Kodu Ordering Code Код для заказа	Stok Stock Наличие		Takım Ölçüleri (mm) Dimension (mm) Размеры (мм)				Kesici Uç Insert Пластина	Sıkma Vidası Screw Зажимной винт	Altlık Shim Опорная пластина	Altlık Vidası Shim Screw Винт опорной пластины	Tork Anahtar Torx Key Торх Ключ
	R	L	HF=H	B	LF	WF					
SSSCR/L 1212 F09	●	●	12	12	80	16	SC.T 09T3..	4015-M3.5x11	-	-	80-T15
1616 H09	●	●	16	16	100	20		4015-M3.5x14	AASN-2-0001	AAV-06-M3.5x11	
2020 K09	●	●	20	20	125	25		4020-M4.5x12		AAV-10-M4.5x8	
1616 H12	●	●	16	16	100	20	SC.T 1204..	1020-M4.5x16	AASN-2-0004	AAV-07-M4.5x13	80-T20
2020 K12	●	●	20	20	125	25					
2525 M12	●	●	25	25	150	32					

R: Sağ / Right / Правый L: Sol / Left / Левый

● Stokta / In Stock / В наличии ○ Stokta Yok / Non Stock Item / Нет в наличии

Sipariş Örneği/Ordering Example/Образец заказа

1 ad./pcs./шт. SSDCN 1212 F09

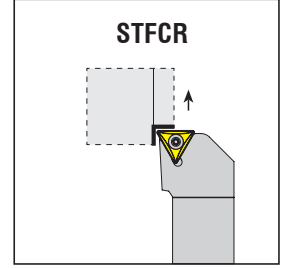
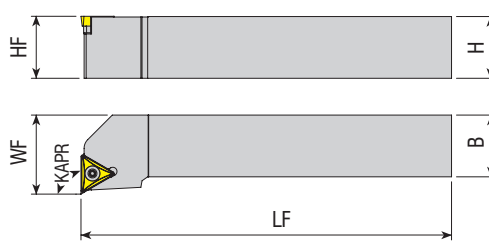

**Takım Kodu**  
**Ordering Code**  
Код для заказа

Stok Stock Наличие	Takım Ölçüleri (mm) Dimension (mm) Размеры (мм)					Kesici Uç Insert Пластина	Yedek Parçaları / Spare Parts / Запасные части			
	R	L	HF=H	B	LF		WF	Sikma Vidası Screw Зажимной винт	Altlık Shim Опорная пластина	Altlık Vidası Shim Screw Винт опорной пластины
○	○	08	08	70	10	TC.T 0902..	3007-M2.2x5	-	-	80-T07
●	●	10	10	70	12					
●	●	12	12	80	16	TC.T 1102..	4008-M2.5x6	-	-	80-T08
●	●	16	16	100	20					
●	●	16	16	100	20	TC.T 16T3..	4015-M3.5x14	AATN-2-0001	AAV-06-M3.5x11	80-T15
●	●	20	20	125	25					
●	●	25	25	150	32					
●	●	32	32	170	40					

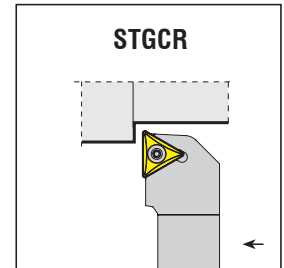
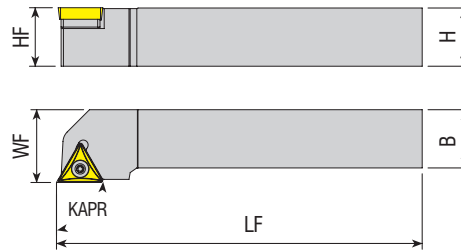

**Takım Kodu**  
**Ordering Code**  
Код для заказа

Stok Stock Наличие	Takım Ölçüleri (mm) Dimension (mm) Размеры (мм)					Kesici Uç Insert Пластина	Yedek Parçaları / Spare Parts / Запасные части			
	R	L	HF=H	B	LF		WF	Sikma Vidası Screw Зажимной винт	Altlık Shim Опорная пластина	Altlık Vidası Shim Screw Винт опорной пластины
●	●	08	08	70	10	TC.T 0902..	3007-M2.2x5	-	-	80-T07
●	●	10	10	70	12					
●	●	12	12	80	16	TC.T 1102..	4008-M2.5x6	-	-	80-T08
●	●	16	16	100	20					
●	●	16	16	100	20	TC.T 16T3..	4015-M3.5x14	AATN-2-0001	AAV-06-M3.5x11	80-T15
●	●	20	20	125	25					
●	●	25	25	150	32					
●	●	32	32	170	40					

R: Sağ / Right / Правый L: Sol / Left / Левый  
● Stokta / In Stock / В наличии ○ Stokta Yok / Non Stock Item / Нет в наличии

Sipariş Örneği/Ordering Example/Образец заказа  
1 ad./pcs./шт. STFGR 0808 E09

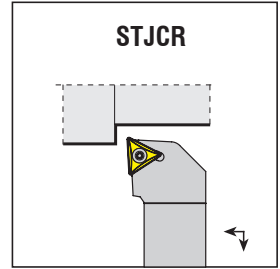
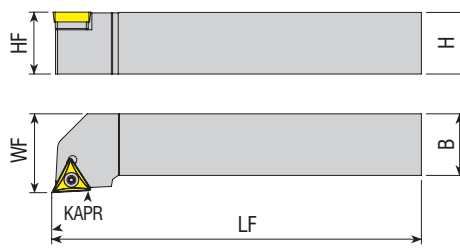
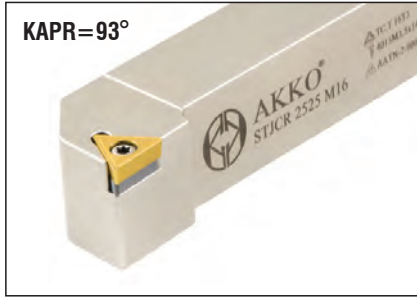

**Takım Kodu**  
**Ordering Code**  
Код для заказа

Stok Stock Наличие	Takım Ölçüleri (mm) Dimension (mm) Размеры (мм)					Kesici Uç Insert Пластина	Yedek Parçaları / Spare Parts / Запасные части				
	R	L	HF=H	B	LF		WF	Sıkma Vidası Screw Зажимной винт	Altık Shim Опорная пластина	Altık Vidası Shim Screw Винт опорной пластины	Tork Anahtar Torx Key Торх Ключ
							<b>TC.T 0902..</b>	3007-M2.2x5	-	-	80-T07
							<b>TC.T 1102..</b>	4008-M2.5x6	-	-	80-T08
							<b>TC.T 16T3..</b>	4015-M3.5x14	AATN-2-0001	AAV-06-M3.5x11	80-T15

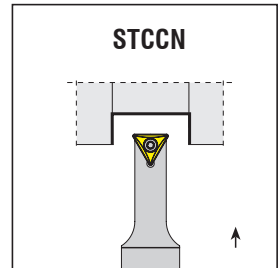
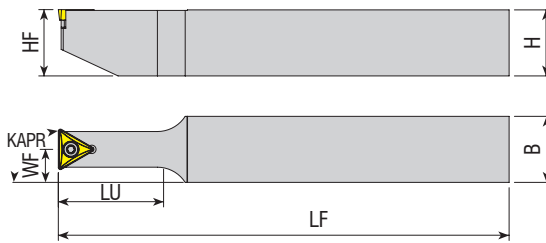

**Takım Kodu**  
**Ordering Code**  
Код для заказа

Stok Stock Наличие	Takım Ölçüleri (mm) Dimension (mm) Размеры (мм)						Kesici Uç Insert Пластина	Yedek Parçaları / Spare Parts / Запасные части			
	HF=H	B	LF	WF	LU	Sıkma Vidası Screw Зажимной винт		Altık Shim Опорная пластина	Altık Vidası Shim Screw Винт опорной пластины	Tork Anahtar Torx Key Торх Ключ	
							<b>TC.T 1102..</b>	4008-M2.5x6	-	-	80-T08
							<b>TC.T 16T3..</b>	4015-M3.5x14	AATN-2-0001	AAV-06-M3.5x11	80-T15
							<b>TC.T 2204..</b>	4020-M4.5x12	-	-	80-T20

R: Sağ / Right / Правый L: Sol / Left / Левый

● Stokta / In Stock / В наличии ○ Stokta Yok / Non Stock Item / Нет в наличии

Sipariş Örneği/Ordering Example/Образец заказа

1 ad./pcs./шт. STJCR 0808 E09

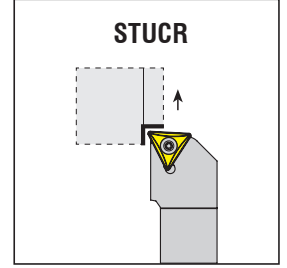
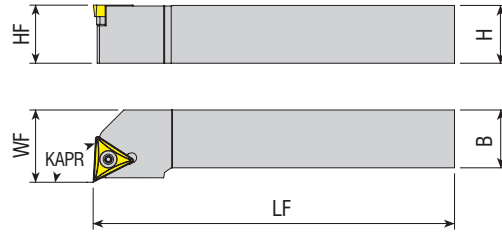

Takım Kodu Ordering Code Код для заказа	Stok Stock Наличие		Takım Ölçüleri (mm) Dimension (mm) Размеры (мм)				Kesici Uç Insert Пластина	Yedek Parçaları / Spare Parts / Запасные части			
	R	L	HF=H	B	LF	WF		Sıkma Vidası Screw Зажимной винт	Altlık Shim Опорная пластина	Altlık Vidası Shim Screw Винт опорной пластины	Tork Anahtar Torx Key Торх Ключ
STUCR/L 0808 E09	●	●	08	08	70	10					80-T07
1010 E09	●	●	10	10	70	12					
1212 F11	●	●	12	12	80	16					
1616 H11	●	●	16	16	100	20	TC.T 1102..	4008-M2.5x6	-	-	80-T08
1616 H16	○	○	16	16	100	20					
2020 K16	●	●	20	20	125	25	TC.T 16T3..	4015-M3.5x14	AATN-2-0001	AAV-06-M3.5x11	80-T15
2525 M16	●	●	25	25	150	32					
3232 P16	●	●	32	32	170	40					

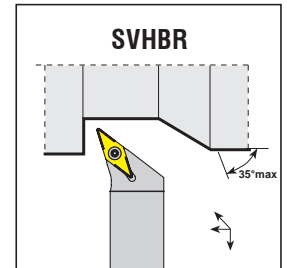
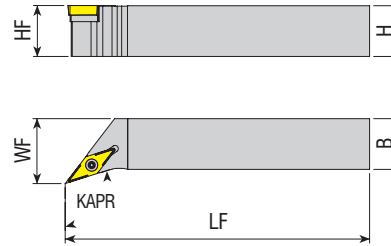
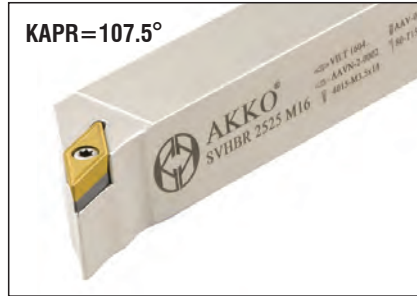

Takım Kodu Ordering Code Код для заказа	Stok Stock Наличие		Takım Ölçüleri (mm) Dimension (mm) Размеры (мм)				Kesici Uç Insert Пластина	Yedek Parçaları / Spare Parts / Запасные части			
	R	L	HF=H	B	LF	WF		Sıkma Vidası Screw Зажимной винт	Altlık Shim Опорная пластина	Altlık Vidası Shim Screw Винт опорной пластины	Tork Anahtar Torx Key Торх Ключ
SVHBR/L 1212 F11	●	●	12	12	80	16		4008-M2.5x6	-	-	80-T08
1616 H11	●	●	16	16	100	20					
2020 K11	●	●	20	20	125	25					
2020 K16	●	●	20	20	125	25	VB.T 1604..	4015-M3.5x14	AAVN-2-0002	AAV-06-M3.5x11	80-T15
2525 M16	●	●	25	25	150	32					
3232 P16	●	●	32	32	170	40					

R: Sağ / Right / Правый L: Sol / Left / Левый  
● Stokta / In Stock / В наличии ○ Stokta Yok / Non Stock Item / Нет в наличии

Sipariş Örneği/Ordering Example/Образец заказа  
1 ad./pcs./шт. STUCR 0808 E09

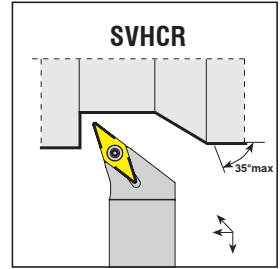
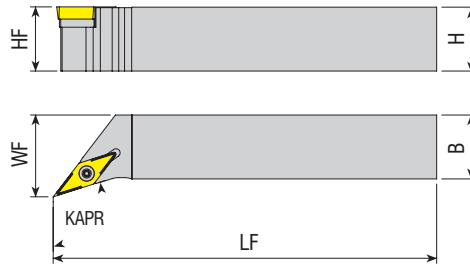
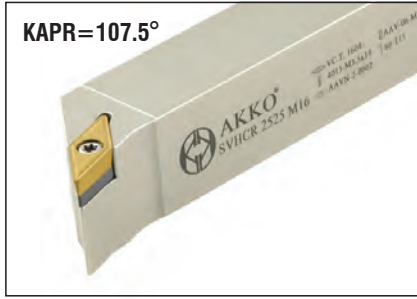

**Takım Kodu**  
**Ordering Code**  
Код для заказа

Stok  
Stock  
Наличие

Takım Ölçüleri (mm)  
Dimension (mm)  
Размеры (мм)

Kesici Uç  
Insert  
Пластина

Yedek Parçaları / Spare Parts / Запасные части

Sıkma Vidası  
Screw  
Зажимной винт

Altlık  
Shim  
Опорная пластина

Altlık Vidası  
Shim Screw  
Винт опорной пластины

Tork Anahtar  
Torx Key  
Torx Ключ

R	L	HF=H	B	LF	WF
●	●	12	12	80	16
●	●	16	16	100	20
●	●	20	20	125	25
●	●	20	20	125	25
●	●	25	25	150	32
●	●	32	32	170	40

<b>VC.T 1103..</b>	4008-M2.5x6	-	-	80-T08
<b>VC.T 1604..</b>	4015-M3.5x14	AAVN-2-0002	AAV-06-M3.5x11	80-T15

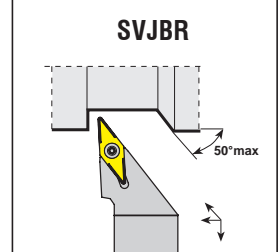
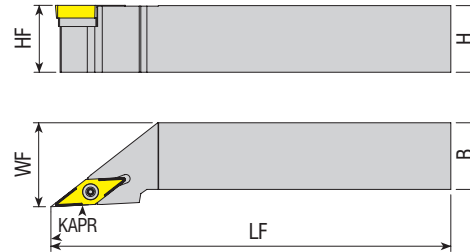

**Takım Kodu**  
**Ordering Code**  
Код для заказа

Stok  
Stock  
Наличие

Takım Ölçüleri (mm)  
Dimension (mm)  
Размеры (мм)

Kesici Uç  
Insert  
Пластина

Yedek Parçaları / Spare Parts / Запасные части

Sıkma Vidası  
Screw  
Зажимной винт

Altlık  
Shim  
Опорная пластина

Altlık Vidası  
Shim Screw  
Винт опорной пластины

Tork Anahtar  
Torx Key  
Torx Ключ

R	L	HF=H	B	LF	WF
●	●	12	12	80	16
●	●	16	16	100	20
●	●	20	20	125	25
●	●	16	16	100	20
●	●	20	20	125	25
●	●	25	25	150	32
●	●	32	32	170	40

<b>VB.T 1103..</b>	4008-M2.5x6	-	-	80-T08
<b>VB.T 1604..</b>	4015-M3.5x14	AAVN-2-0002	AAV-06-M3.5x11	80-T15

R: Sağ / Right / Правый L: Sol / Left / Левый  
● Stokta / In Stock / В наличии ○ Stokta Yok / Non Stock Item / Нет в наличии

Sipariş Örneği/Ordering Example/Образец заказа  
1 ad./pcs./шт. SVHCR 1212 F11



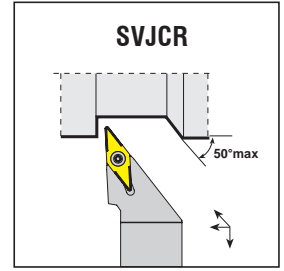
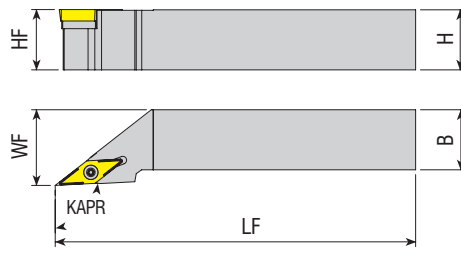

Takım Kodu Ordering Code Код для заказа	Stok Stock Наличие		Takım Ölçüleri (mm) Dimension (mm) Размеры (мм)				Kesici Uç Insert Пластина	Yedek Parçaları / Spare Parts / Запасные части				
	R	L	HF=H	B	LF	WF		Sıkma Vidası Screw Зажимной винт	Altlık Shim Опорная пластина	Altlık Vidası Shim Screw Винт опорной пластины	Tork Anahtar Torx Key Торх Ключ	
SVJCR/L 1212 F11	●	●	12	12	80	16	VC.T 1103..	4008-M2.5x6	-	-	80-T08	
1616 H11	●	●	16	16	100	20						
2020 K11	●	●	20	20	125	25						
2525 M11	●	●	25	25	150	32	VC.T 1604..	4015-M3.5x11	AAVN-2-0002	AAV-06-M3.5x11	80-T15	
1212 F16	●	●	12	12	80	16						
2020 K16	●	●	20	20	125	25						
2525 M16	●	●	25	25	150	32						
3232 P16	●	●	32	32	170	40						

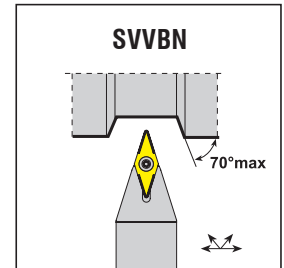
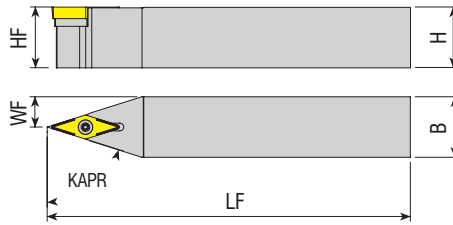

Takım Kodu Ordering Code Код для заказа	Stok Stock Наличие		Takım Ölçüleri (mm) Dimension (mm) Размеры (мм)				Kesici Uç Insert Пластина	Yedek Parçaları / Spare Parts / Запасные части				
	R	L	HF=H	B	LF	WF		Sıkma Vidası Screw Зажимной винт	Altlık Shim Опорная пластина	Altlık Vidası Shim Screw Винт опорной пластины	Tork Anahtar Torx Key Торх Ключ	
SVVBN 1212 F11	●	●	12	12	80	06	VB.T 1103..	4008-M2.5x6	-	-	80-T08	
1616 H11	●	●	16	16	100	08						
2020 K11	●	●	20	20	125	10						
2020 K16	●	●	20	20	125	10	VB.T 1604..	4015-M3.5x14	AAVN-2-0002	AAV-06-M3.5x11	80-T15	
2525 M16	●	●	25	25	150	12.5						
3232 P16	●	●	32	32	170	16						

R: Sağ / Right / Правый L: Sol / Left / Левый  
● Stokta / In Stock / В наличии ○ Stokta Yok / Non Stock Item / Нет в наличии

Sipariş Örneği/Ordering Example/Образец заказа  
1 ad./pcs./шт. SVJCR 1212 F11

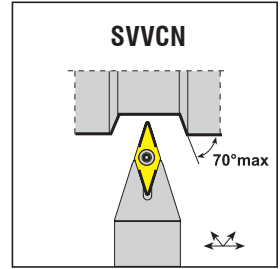
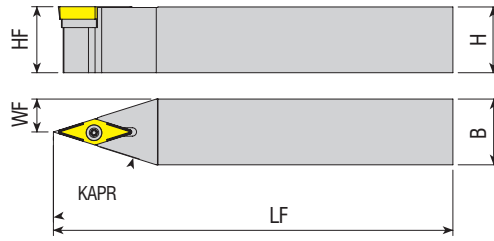

Takım Kodu Ordering Code Код для заказа	Stok Stock Наличие	Takım Ölçüleri (mm) Dimension (mm) Размеры (мм)				Kesici Uç Insert Пластина	Yedek Parçaları / Spare Parts / Запасные части			
		HF=H	B	LF	WF		Sikma Vidası Screw Зажимной винт	Altılık Shim Опорная пластина	Altılık Vidası Shim Screw Винт опорной пластины	Tork Anahtar Torx Key Торх Ключ
SVVCN 1212 F11	●	12	12	80	06	VC.T 1103..	4008-M2.5x6	-	-	80-T08
1616 H11	●	16	16	100	08					
2020 K11	●	20	20	125	10					
2020 K16	●	20	20	125	10	VC.T 1604..	4015-M3.5x14	AAVN-2-0002	AAV-06-M3.5x11	80-T15
2525 M16	●	25	25	150	12.5					
3232 P16	●	32	32	170	16					

S-SİSTEM İSVİÇRE TİPİ KAYAR OTOMAT MAKİNA TAKIMLARI  
S-SYSTEM TOOLS FOR SWISS TYPE SLIDING AUTOMATIC LATHES  
S-ТИП ДЕРЖАВКИ ДЛЯ СТАНКОВ АВТОМАТОВ ШВЕЙЦАРСКОГО ТИПА

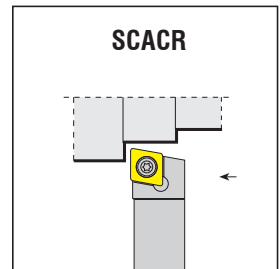
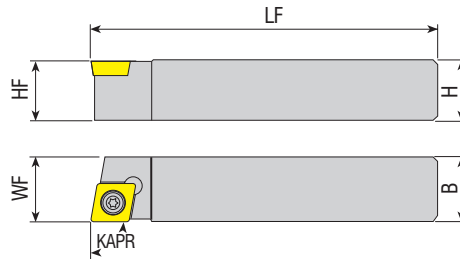
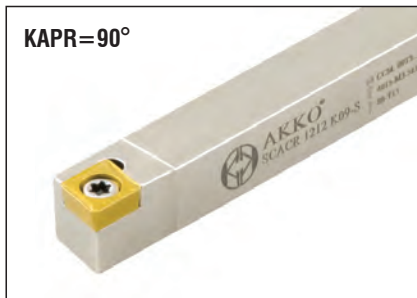

Takım Kodu Ordering Code Код для заказа	Stok Stock Наличие		Takım Ölçüleri (mm) Dimension (mm) Размеры (мм)				Kesici Uç Insert Пластина	Yedek Parçaları / Spare Parts / Запасные части			
	R	L	HF=H	B	LF	WF		Sikma Vidası Screw Зажимной винт	Altılık Shim Опорная пластина	Altılık Vidası Shim Screw Винт опорной пластины	Tork Anahtar Torx Key Торх Ключ
SCACR/L 0808 X06-S	●	●	08	08	115	08	CC.T 0602..	4008-M2.5x6	-	-	80-T08
1010 K06-S	●	○	10	10	125	10					
1212 G06-S	●	○	12	12	90	12					
1212 K06-S	●	○	12	12	125	12					
1616 F06-S	○	○	16	16	75	16					
1616 K06-S	○	○	16	16	125	16					
1212 G09-S	○	○	12	12	90	12	CC.T 09T3..	4015-M3.5x11	-	-	80-T15
1212 K09-S	●	●	12	12	125	12					
1616 F09-S	○	○	16	16	75	16					
1616 K09-S	●	●	16	16	125	16					
2020 K09-S	●	●	20	20	125	20					

R: Sağ / Right / Правый L: Sol / Left / Левый  
● Stokta / In Stock / В наличии ○ Stokta Yok / Non Stock Item / Нет в наличии

Sipariş Örneği/Ordering Example/Образец заказа  
1 ad./pcs./шт. SVVCN 1212 F11

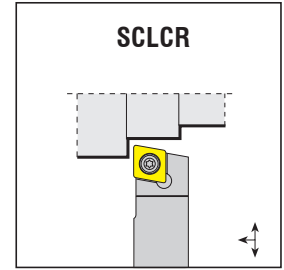
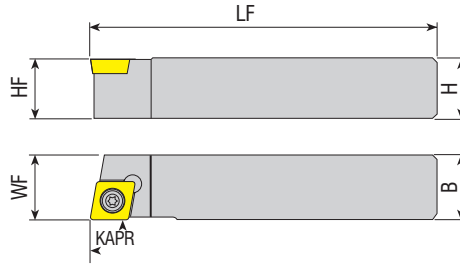
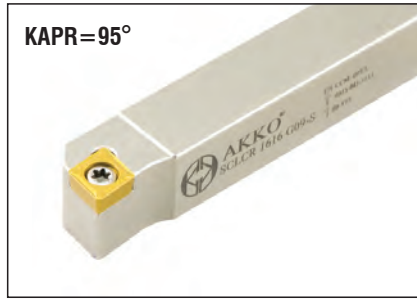

Takım Kodu Ordering Code Код для заказа	Stok Stock Наличие		Takım Ölçüleri (mm) Dimension (mm) Размеры (мм)				Kesici Uç Insert Пластина	Yedek Parçaları / Spare Parts / Запасные части								
	R	L	HF=H	B	LF	WF		Sıkma Vidası Screw Зажимной винт	Altlık Shim Опорная пластина	Altlık Vidası Shim Screw Винт опорной пластины	Tork Anahtar Torx Key Торх Ключ					
<b>SCLCR/L 0808 X06-S</b>	●	●	08	08	115	08	<b>CC.T 0602..</b>	4008-M2.5x6	-	-	80-T08					
<b>1010 X06-S</b>	●	○	10	10	115	10										
<b>1212 G06-S</b>	●	●	12	12	90	12										
<b>1212 X06-S</b>	●	○	12	12	130	12										
<b>1212 K06-S</b>	○	●	12	12	125	12										
<b>1616 F06-S</b>	●	○	16	16	75	16										
<b>1616 X06-S</b>	●	○	16	16	130	16										
<b>1212 G09-S</b>	●	●	12	12	90	12						<b>CC.T 09T3..</b>	4015-M3.5x11	-	-	80-T15
<b>1212 X09-S</b>	●	○	12	12	130	12										
<b>1616 F09-S</b>	●	○	16	16	75	16										
<b>1616 G09-S</b>	●	○	16	16	90	16										
<b>1616 X09-S</b>	●	○	16	16	115	16										
<b>2020 X09-S</b>	●	○	20	20	120	20										

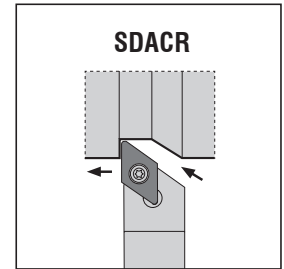
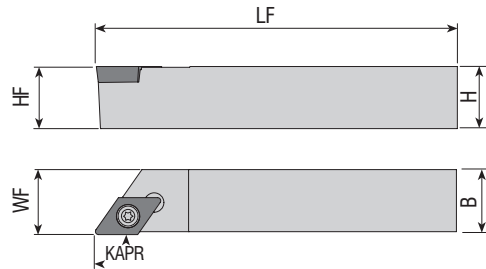
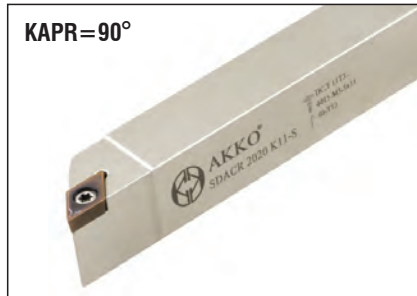

Takım Kodu Ordering Code Код для заказа	Stok Stock Наличие		Takım Ölçüleri (mm) Dimension (mm) Размеры (мм)				Kesici Uç Insert Пластина	Yedek Parçaları / Spare Parts / Запасные части				
	R	L	HF=H	B	LF	WF		Sıkma Vidası Screw Зажимной винт	Altlık Shim Опорная пластина	Altlık Vidası Shim Screw Винт опорной пластины	Tork Anahtar Torx Key Торх Ключ	
<b>SDACR/L 0808 X07-S</b>	●	●	08	08	115	08	<b>DC.T 0702..</b>	4008-M2.5x6	-	-	80-T08	
<b>1010 K07-S</b>	●	●	10	10	125	10						
<b>1212 G07-S</b>	○	○	12	12	90	12						
<b>1212 K07-S</b>	●	●	12	12	125	12						
<b>1616 F07-S</b>	●	○	16	16	75	16						
<b>1616 K07-S</b>	●	●	16	16	125	16						<b>DC.T 11T3..</b>
<b>1212 G11-S</b>	○	○	12	12	90	12						
<b>1212 K11-S</b>	●	●	12	12	125	12						
<b>1616 F11-S</b>	●	○	16	16	75	16						
<b>1616 K11-S</b>	●	●	16	16	125	16						
<b>2020 K11-S</b>	●	●	20	20	125	20						

R: Sağ / Right / Правый L: Sol / Left / Левый  
 ● Stokta / In Stock / В наличии ○ Stokta Yok / Non Stock Item / Нет в наличии

Sipariş Örneği/Ordering Example/Образец заказа  
 1 ad./pcs./шт. SCLCR 0808 X06-S

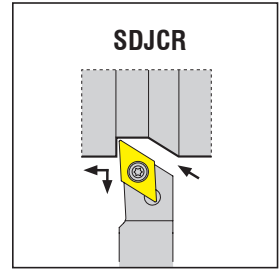
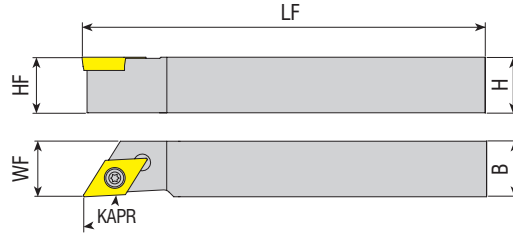
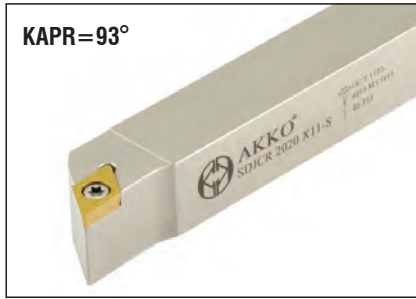

Takım Kodu Ordering Code Код для заказа	Stok Stock Наличие		Takım Ölçüleri (mm) Dimension (mm) Размеры (мм)				Kesici Uç Insert Пластина	Yedek Parçaları / Spare Parts / Запасные части			
	R	L	HF=H	B	LF	WF		Sıkma Vidası Screw Зажимной винт	Altlık Shim Опорная пластина	Altlık Vidası Shim Screw Винт опорной пластины	Tork Anahtar Torx Key Торх Ключ
SDJCR/L 0808 X07-S	●	○	08	08	115	08	DC.T 0702..	4008-M2.5x6	-	-	80-T08
1010 X07-S	●	●	10	10	115	10					
1212 G07-S	●	○	12	12	90	12					
1212 X07-S	●	●	12	12	130	12					
1616 F07-S	●	○	16	16	75	16					
1616 X07-S	●	○	16	16	130	16					
2020 X07-S	●	○	20	20	120	20					
1212 G11-S	●	○	12	12	90	12	DC.T 11T3..	4015-M3.5x11	-	-	80-T15
1212 X11-S	●	●	12	12	130	12					
1212 K11-S	●	●	12	12	125	12					
1616 F11-S	●	○	16	16	75	16					
1616 X11-S	●	●	16	16	130	16					
1616 K11-S	●	●	16	16	125	16					
2020 X11-S	●	○	20	20	120	20					

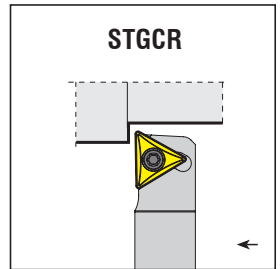
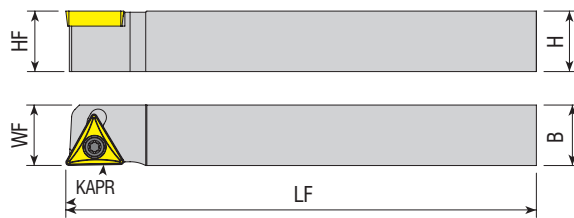

Takım Kodu Ordering Code Код для заказа	Stok Stock Наличие		Takım Ölçüleri (mm) Dimension (mm) Размеры (мм)				Kesici Uç Insert Пластина	Yedek Parçaları / Spare Parts / Запасные части			
	R	L	HF=H	B	LF	WF		Sıkma Vidası Screw Зажимной винт	Altlık Shim Опорная пластина	Altlık Vidası Shim Screw Винт опорной пластины	Tork Anahtar Torx Key Торх Ключ
STGCR/L 1216 K11-S	●	○	12	16	125	16	TC.T 1102..	4008-M2.5x6	-	-	80-T08
1616 K11-S	●	○	16	16	125	16					
1216 K16-S	●	○	12	16	125	16	TC.T 16T3..	4015-M3.5x11	-	-	80-T15
1616 K16-S	●	○	16	16	125	16					

R: Sağ / Right / Правый L: Sol / Left / Левый

● Stokta / In Stock / В наличии ○ Stokta Yok / Non Stock Item / Нет в наличии

Sipariş Örneği/Ordering Example/Образец заказа

1 ad./pcs./шт. SDJCR 0808 X07-S

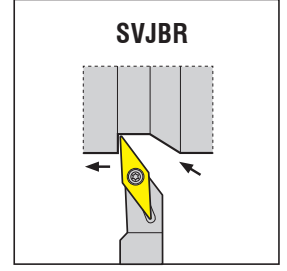
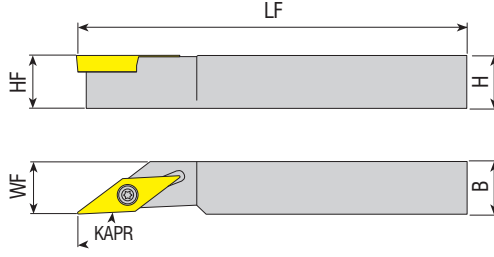

Takım Kodu Ordering Code Код для заказа	Stok Stock Наличие		Takım Ölçüleri (mm) Dimension (mm) Размеры (мм)				Kesici Uç Insert Пластина	Yedek Parçaları / Spare Parts / Запасные части			
	R	L	HF=H	B	LF	WF		Sıkma Vidası Screw Зажимной винт	Altlık Shim Опорная пластина	Altlık Vidası Shim Screw Винт опорной пластины	Tork Anahtar Torx Key Торх Ключ
SVJBR/L 1616 K11-S	●	●	16	16	125	16			-	-	

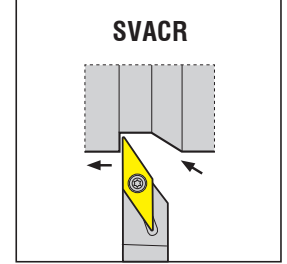
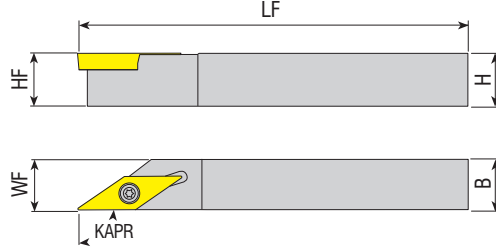

Takım Kodu Ordering Code Код для заказа	Stok Stock Наличие		Takım Ölçüleri (mm) Dimension (mm) Размеры (мм)				Kesici Uç Insert Пластина	Yedek Parçaları / Spare Parts / Запасные части			
	R	L	HF=H	B	LF	WF		Sıkma Vidası Screw Зажимной винт	Altlık Shim Опорная пластина	Altlık Vidası Shim Screw Винт опорной пластины	Tork Anahtar Torx Key Торх Ключ
SVACR/L 0808 X11-S	○	○	08	08	115	08			-	-	
1010 K11-S	●	○	10	10	125	10					
1212 G11-S	○	○	12	12	90	12					
1212 K11-S	●	●	12	12	125	12					
1616 F11-S	○	○	16	16	75	16					
1616 K11-S	●	●	16	16	125	16					
2020 K11-S	●	●	20	20	125	20			-	-	
1212 K16-S	●	●	12	12	125	12					
1616 K16-S	●	●	16	16	125	16					

R: Sağ / Right / Правый L: Sol / Left / Левый  
● Stokta / In Stock / В наличии ○ Stokta Yok / Non Stock Item / Нет в наличии

Sipariş Örneği/Ordering Example/Образец заказа  
1 ad./pcs./шт. SVJBR 1616 K11-S

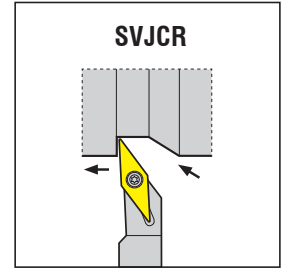
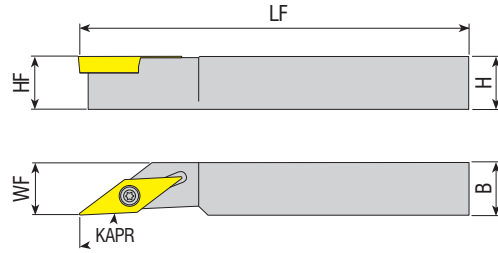

Takım Kodu Ordering Code Код для заказа	Stok Stock Наличие		Takım Ölçüleri (mm) Dimension (mm) Размеры (мм)				Kesici Uç Insert Пластина	Yedek Parçaları / Spare Parts / Запасные части			
	R	L	HF=H	B	LF	WF		Sıkma Vidası Screw Зажимной винт	Altlık Shim Опорная пластина	Altlık Vidası Shim Screw Винт опорной пластины	Tork Anahtar Torx Key Торк Ключ
SVJCR/L 0808 X11-S	●	○	08	08	115	08	VC.T 1103..	4008-M2.5x6	-	-	80-T08
1010 K11-S	●	○	10	10	125	10					
1212 G11-S	○	○	12	12	90	12					
1212 K11-S	●	●	12	12	125	12					
1616 F11-S	○	○	16	16	75	16					
1616 K11-S	●	○	16	16	125	16					
2020 K11-S	○	○	20	20	125	20					

SEC TOOLS

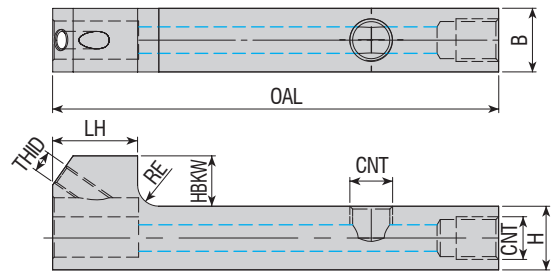

Takım Kodu Ordering Code Код для заказа	Stok Stock Наличие	Takım Ölçüleri (mm) Dimension (mm) Размеры (мм)								Yedek Parçaları / Spare Parts / Запасные части		
		H	B	RE	HBKW	LH	OAL	CNT	THID	Sızdırmaz Vida Threaded Pin Резьбовой Винт	Montaj Vidası Mounting Screw Монтажный винт	Anahtar Allen Key Ключ
ASTB-1212-L84-H	●	12	12	4	9.5	16	84	M8X1X5	M4x0.7	2704-M8X1X5	2503-M4x12-C	AAL-03-3
ASTB-1616-L90-H	●	16	16	1	5.5	16	90	M8X1X5	M4x0.7			

R: Sağ / Right / Правый L: Sol / Left / Левый

● Stokta / In Stock / В наличии ○ Stokta Yok / Non Stock Item / Нет в наличии

Sipariş Örneği/Ordering Example/Образец заказа

1 ad./pcs./шт. SVJCR 0808 X11-S



KAPR=93°

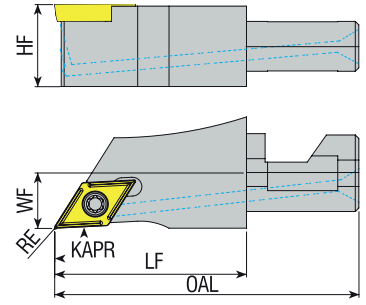

Yedek Parçaları / Spare Parts / Запасные части

Takım Kodu Ordering Code Код для заказа	Stok Stock Наличие		Takım Ölçüleri (mm) Dimension (mm) Размеры (мм)				Kesici Uç Insert Пластина	Yedek Parçaları / Spare Parts / Запасные части		
	R	L	HF	WF	RE	LF		OAL	Sıkma Vidası Screw Зажимной винт	Tork Anahtar Torx Key Торх Ключ
SDJCR/L-12X43.3-07	●	●	11.8	8	0.2	27.3	43.3	DC.T 070202	4008-M2.5x6	80-T08
12X43.3-07-H	●	●	11.8	8	0.2	27.3	43.3			
16X43.3-07	●	●	15.8	8	0.2	27.3	43.3			
16X43.3-07-H	●	●	15.8	8	0.2	27.3	43.3			
12X43.3-11	●	●	11.8	8	0.2	27.3	43.3	DC.T 11T302	4015-M3.5x9	80-T15
12X43.3-11-H	●	●	11.8	8	0.2	27.3	43.3			
16X43.3-11	●	●	15.8	8	0.2	27.3	43.3			
16X43.3-11-H	●	●	15.8	8	0.2	27.3	43.3			



KAPR=93°

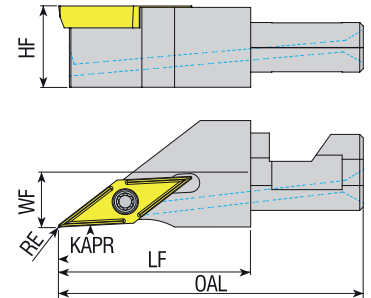

Yedek Parçaları / Spare Parts / Запасные части

Takım Kodu Ordering Code Код для заказа	Stok Stock Наличие		Takım Ölçüleri (mm) Dimension (mm) Размеры (мм)				Kesici Uç Insert Пластина	Yedek Parçaları / Spare Parts / Запасные части		
	R	L	HF	WF	RE	LF		OAL	Sıkma Vidası Screw Зажимной винт	Tork Anahtar Torx Key Торх Ключ
SVJCR/L-12X43.3-11	●	●	11.8	8	0.2	27.3	43.3	VC.T 110302	4008-M2.5x6	80-T08
12X43.3-11-H	●	●	11.8	8	0.2	27.3	43.3			
16X43.3-11	●	●	15.8	8	0.2	27.3	43.3			
16X43.3-11-H	●	●	15.8	8	0.2	27.3	43.3			

R: Sağ / Right / Правый L: Sol / Left / Левый

● Stokta / In Stock / В наличии ○ Stokta Yok / Non Stock Item / Нет в наличии

Sipariş Örneği/Ordering Example/Образец заказа

1 ad./pcs./шт. SDJCR-12X43.3-07

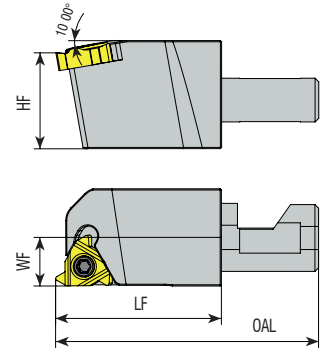

**Takım Kodu**  
**Ordering Code**  
Код для заказа

Stok Stock Наличие		Takım Ölçüleri (mm) Dimension (mm) Размеры (мм)					Kesici Uç Insert Пластина	Yedek Parçaları / Spare Parts / Запасные части					
		R	L	OAL	LF	WF		HF	Sıkma Vidası Screw Зажимной винт	Sağ Altlık Right Shim правая подкладная пластина	Sol Altlık Left Shim левая подкладная пластина	Altlık Vidası Shim Screw Винт опорной пластины	Altlık Vidası Pulu Shim Screw Ring Винт опорной пластины/пту
							<b>11 ER/EL</b>	4008-M2.5x6	-	-	-	-	80-T08
							<b>16 ER/EL</b>	1710-U5-40x12.2	ATS-16E	ATS-16I	AAV-11-U5-40x4.5	ABPL-03	80-T10

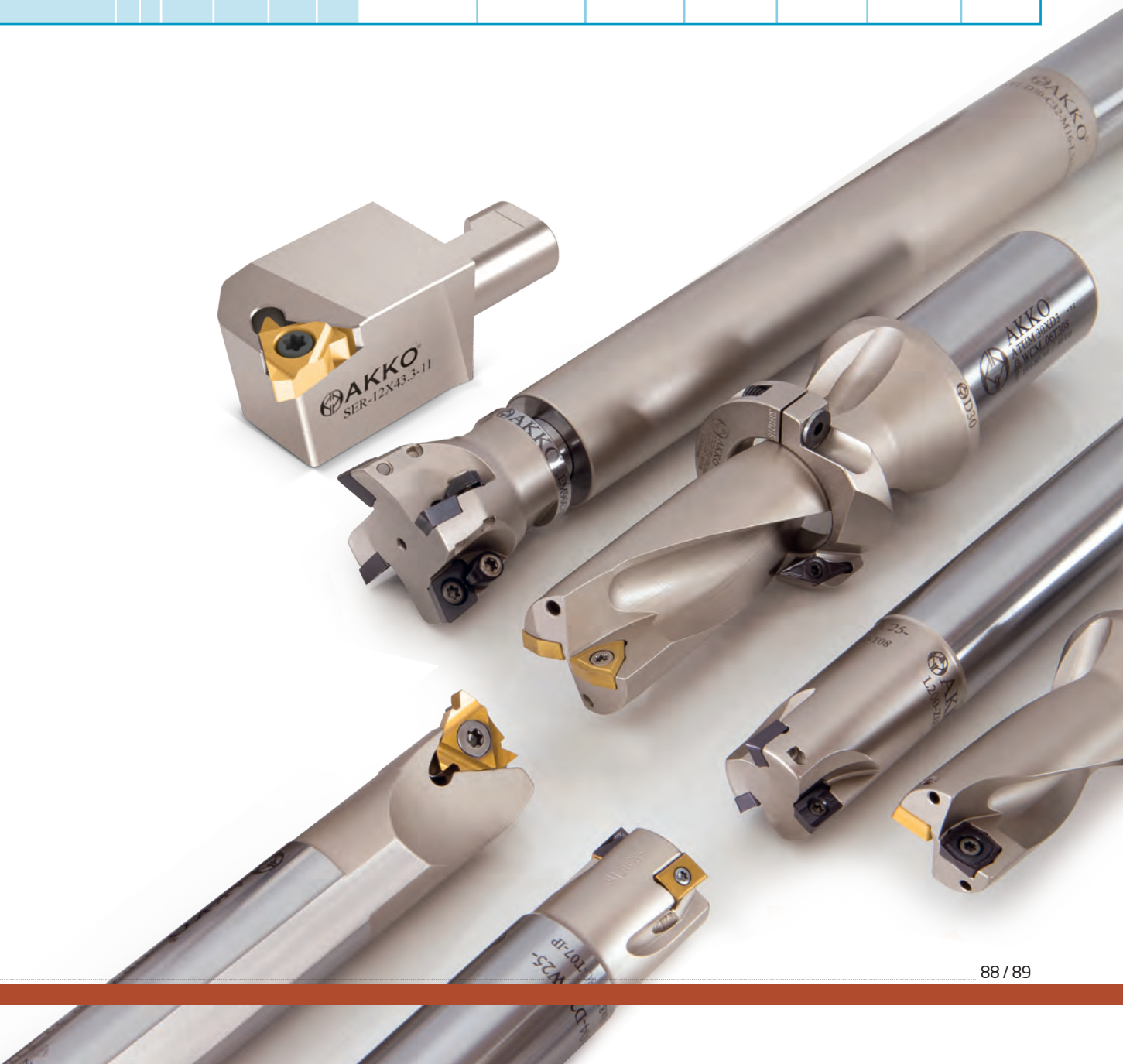



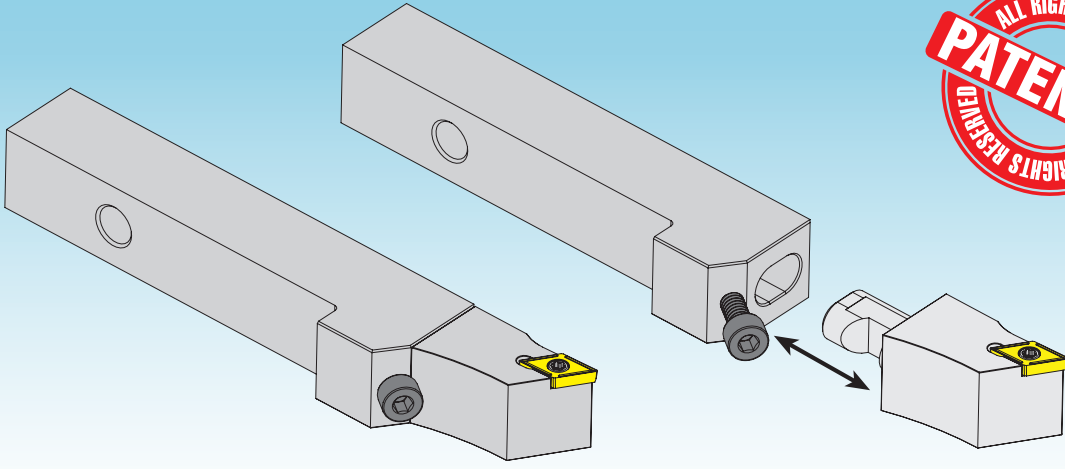

Takım tutucuyu, bağlama ünitesinden sökme zorunluğ u kalmadan hızlıca deęiřtirin!

Quick change, without having to remove the tool-holder from the gang !

Быстрое извлечение картриджа для замены пластины. При этом, не требуется снимать державку из резцедержателя.

Makina dıřında ön ayar yapmak mümkün.

Presetting is possible outside of the machine.

Возможность предварительной настройке не в станке

Çok hassas montaj.

Ultra precise fitting.

Ультраточное соединение при сборке

Rijit sabitleme.

Rigid fixation.

Жесткая фиксация

Takım tutucu bölümü: 12x12 ve 16x16 mm.

Tool-holder section : 12x12 and 16x16 mm.

Размер секции для держателя инструмена 12x12 и 16x16мм

Saę ve sol uçlar kullanılır.

Left and right inserts available.

Используются левые и правые пластины

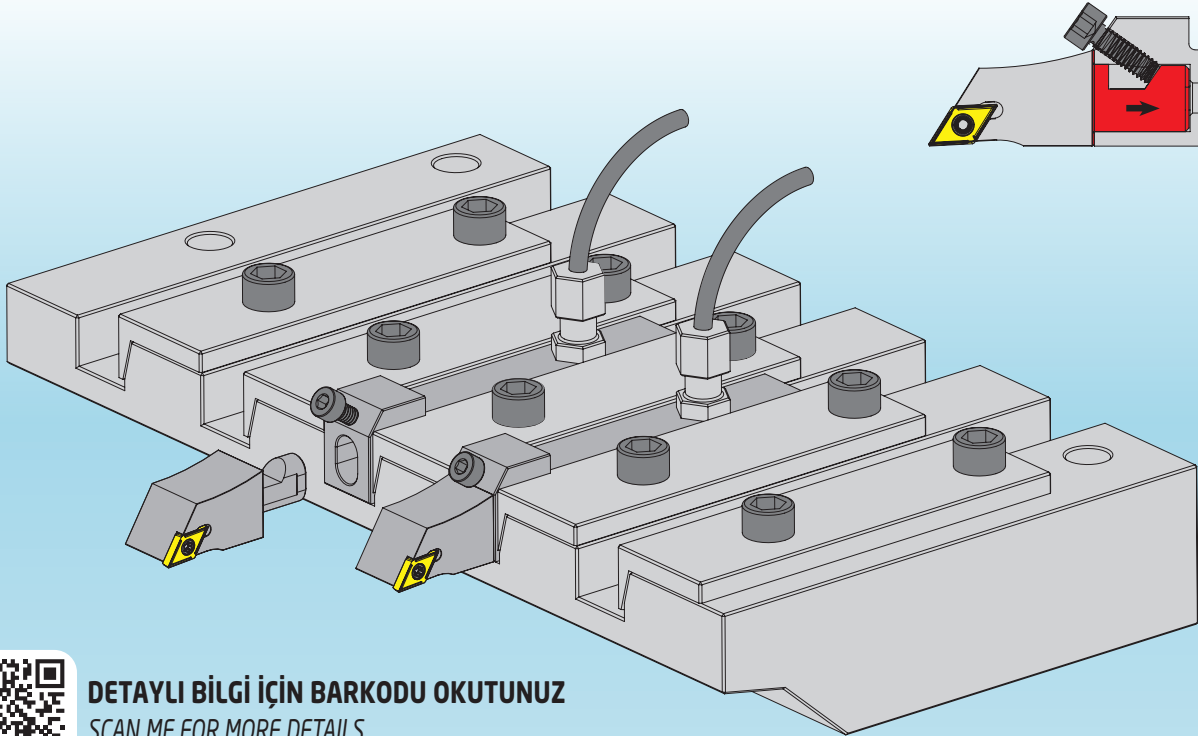

**DETAYLI BİLGİ İÇİN BARKODU OKUTUNUZ**

SCAN ME FOR MORE DETAILS

ПРОСКАНИРУЙТЕ ДЛЯ ПОЛУЧЕНИЯ БОЛЕЕ ПОДРОБНОЙ ИНФОРМАЦИИ

**DELİK TORNA TAKIMLARI**  
**INTERNAL TURNING TOOLHOLDERS**  
**РАСТОЧНЫЕ ДЕРЖАВКИ**





**1** Takım Malzemesi / Type of Boring Bar / Тип скучного бара вставки  
 "A" Yekpare çelik gövde soğutma suyu kanallı / "A" Solid steel with coolant hole  
 "A" Расточная державка из твердой стали с подвожом СОЖ  
 "E" Çelik başlıkla sert metal gövde ve soğutma suyu kanallı / "E" Carbide bar with fixed steel head and coolant hole  
 "E" Расточная державка из твердосплавного карбида с подвожом СОЖ  
 "C" Karbür Şaft / "C" Carbide shank / "C" Расточная державка из твердосплавного карбида  
 "S" Çelik Şaft / "S" Steel shank / "S" Расточная державка из твердой стали

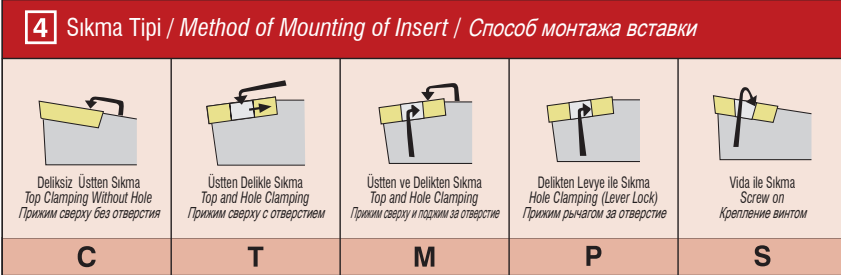
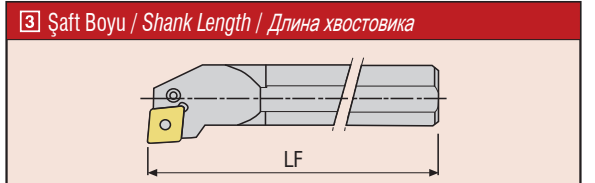

A - 32	H - 100	Q - 180	x-special
B - 40	J - 110	R - 200	
C - 50	K - 125	S - 250	
D - 60	L - 140	T - 300	
E - 70	M - 150	U - 350	
F - 80	N - 160	V - 400	
G - 90	P - 170	W - 450	

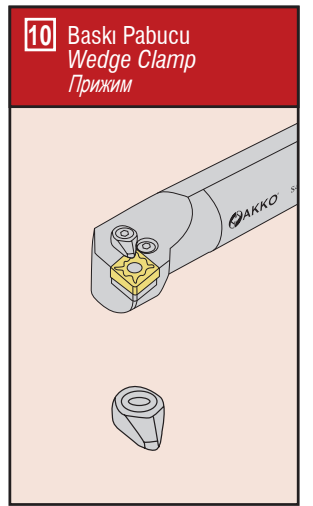
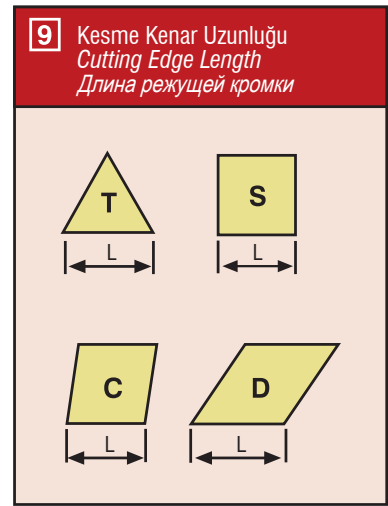
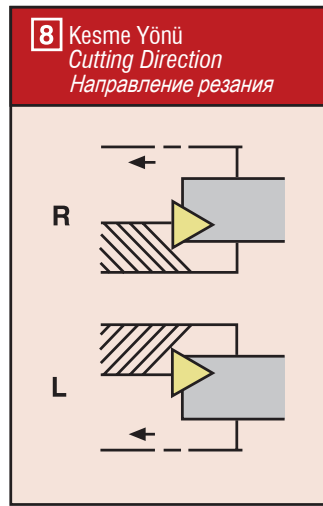
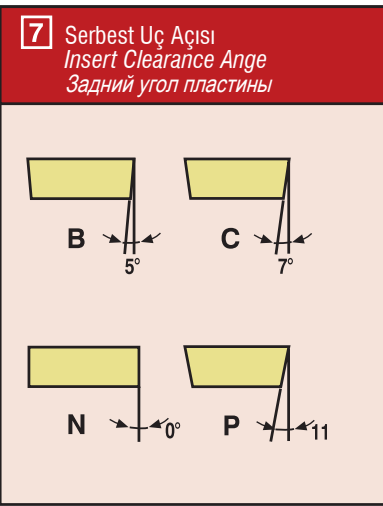
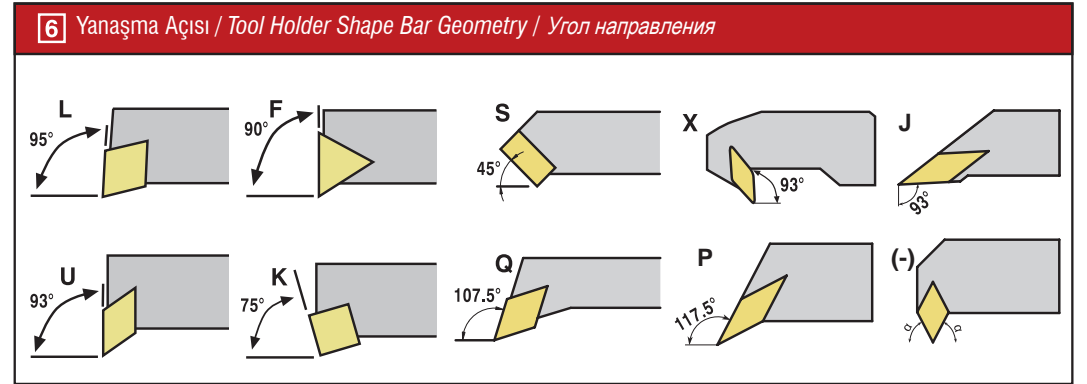
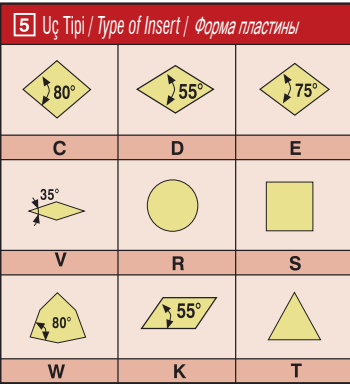



# T&C-SİSTEM

T&C SİSTEM DELİK TORNA KATERLERİ  
T&C SYSTEM BORING BARS  
Т И С-ТИП РАСТОЧНЫЕ ДЕРЖАВКИ

*konusulan  
the spoken kalite...  
quality...*



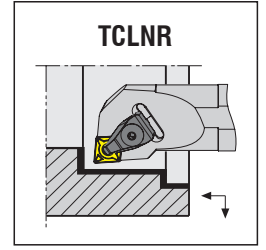
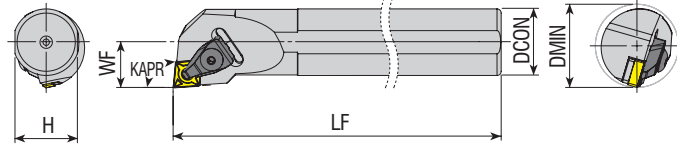

Yedek Parçaları / Spare Parts / Запасные части

Takım Kodu Ordering Code Код для заказа	Stok Stock Наличие		Takım Ölçüleri (mm) Dimension (mm) Размеры (мм)					Kesici Uç Insert Пластина	Baskı Pabucu Wedge Clamp Прижим	Pabuç Vidası Clamp Screw Зажимной винт	Altlık Shim Отпорная пластина	Altlık Vidası Shim Screw Винт отпорной пластины	Sekman Ring Кольцо	Pul Stamp Шайба	Anahtar Allen Key Ключ
	R	L	DCON	H	LF	WF	DMIN								
S25S TCLNR/L 09	●	●	25	23	250	17	≥32	CNM. 0903..	ATK-01	AKV-01-M5x22	AACN -2-0001	AAV-09-M5x9	-		
S25S TCLNR/L 12	●	●	25	23	250	17	≥32					AAV-13-M5x8			
S32T TCLNR/L 12	●	●	32	30	300	22	≥40	CNM. 1204..	ATK-02	AKV-30-M6x22	AACN -3-0001	AAV-02-M5x12	AS-01	ABPL-01	AAL-03-3
S40U TCLNR/L 12	●	●	40	37.5	350	27	≥50								
S50V TCLNR/L 12	●	●	50	47	400	35	≥63								
S32T TCLNR/L 16	●	●	32	30	300	22	≥40	CNM. 1606..	ATK-04	AKV-19-M7x25	AACN -3-0002	AAV-05-M6x15	AS-02	ABPL-02	AAL-05-4
S40U TCLNR/L 16	●	●	40	37.5	350	27	≥50								
S50V TCLNR/L 16	●	●	50	47	400	35	≥63								

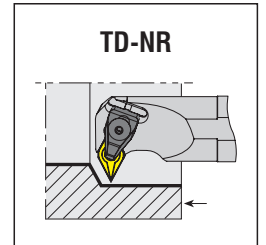
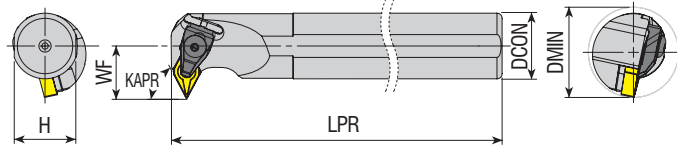

Yedek Parçaları / Spare Parts / Запасные части

Takım Kodu Ordering Code Код для заказа	Stok Stock Наличие		Takım Ölçüleri (mm) Dimension (mm) Размеры (мм)					Kesici Uç Insert Пластина	Baskı Pabucu Wedge Clamp Прижим	Pabuç Vidası Clamp Screw Зажимной винт	Altlık Shim Отпорная пластина	Altlık Vidası Shim Screw Винт отпорной пластины	Sekman Ring Кольцо	Pul Stamp Шайба	Anahtar Allen Key Ключ
	R	L	DCON	H	LPR	WF	DMIN								
S32T TD-NR/L 15	●	●	32	30	300	26	≥44	DNM. 1506..	ATK-02	AKV-30-M6x22	AADN-3-0001	AAV-02-M5x12	AS-01	ABPL-01	AAL-03-3
S40U TD-NR/L 15	●	●	40	37.5	350	29	≥52								
S50V TD-NR/L 15	●	●	50	47	400	35	≥63								

R: Sağ / Right / Правый L: Sol / Left / Левый  
● Stokta / In Stock / В наличии ○ Stokta Yok / Non Stock Item / Нет в наличии

Sipariş Örneği/Ordering Example/Образец заказа  
1 ad./pcs./шт. S25S TCLNR 09

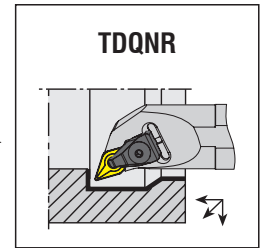
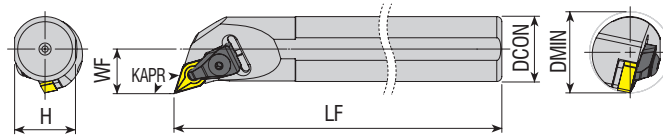

Takım Kodu Ordering Code Код для заказа	Stok Stock Наличие		Takım Ölçüleri (mm) Dimension (mm) Размеры (мм)					Kesici Uç Insert Пластина	Yedek Parçaları / Spare Parts / Запасные части						
	R	L	DCON	H	LF	WF	DMIN		Baskı Pabuçu Wedge Clamp Прижим	Pabuç Vidası Clamp Screw Зажимный винт	Altlık Shim Опорная пластина	Altlık Vidası Shim Screw Винт опорной пластины	Sekman Ring Кольцо	Pul Stamp Шайба	Anahtar Allen Key Ключ
S25S TDQNR/L 11	●	●	25	23	250	17	≥32	DNM. 1104..	ATK-01	AKV-01-M5x22	AADN-2-0001	AAV-09-M5x9	-	ABPL-01	AAL-03-3
S32T TDQNR/L 11	●	●	32	30	300	22	≥40					AAV-04-M5x12			
S25S TDQNR/L 15	●	●	25	23	250	17	≥32	DNM. 1506..	ATK-02	AKV-30-M6x22	AADN-3-0001	AAV-13-M5x8	AS-01	ABPL-01	AAL-03-3
S32T TDQNR/L 15	●	●	32	30	300	22	≥40					AAV-02-M5x12			
S40U TDQNR/L 15	●	●	40	37.5	350	27	≥50								
S50V TDQNR/L 15	●	●	50	47	400	35	≥63								

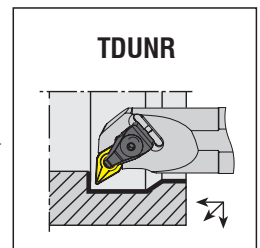
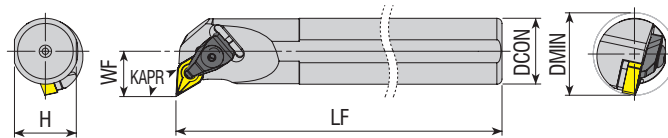

Takım Kodu Ordering Code Код для заказа	Stok Stock Наличие		Takım Ölçüleri (mm) Dimension (mm) Размеры (мм)					Kesici Uç Insert Пластина	Yedek Parçaları / Spare Parts / Запасные части						
	R	L	DCON	H	LF	WF	DMIN		Baskı Pabuçu Wedge Clamp Прижим	Pabuç Vidası Clamp Screw Зажимный винт	Altlık Shim Опорная пластина	Altlık Vidası Shim Screw Винт опорной пластины	Sekman Ring Кольцо	Pul Stamp Шайба	Anahtar Allen Key Ключ
S25S TDUNR/L 11	●	●	25	23	250	17	≥32	DNM. 1104..	ATK-01	AKV-01-M5x22	AADN-2-0001	AAV-09-M5x9	-	ABPL-01	AAL-03-3
S32T TDUNR/L 11	●	●	32	30	300	22	≥40					AAV-04-M5x12			
S25S TDUNR/L 15	●	●	25	23	250	17	≥34	DNM. 1506..	ATK-02	AKV-30-M6x22	AADN-3-0001	AAV-13-M5x8	AS-01	ABPL-01	AAL-03-3
S32T TDUNR/L 15	●	●	32	30	300	22	≥40					AAV-02-M5x12			
S40U TDUNR/L 15	●	●	40	37.5	350	27	≥50								
S50V TDUNR/L 15	●	●	50	47	400	35	≥63								

R: Sağ / Right / Правый L: Sol / Left / Левый  
● Stokta / In Stock / В наличии ○ Stokta Yok / Non Stock Item / Нет в наличии

Sipariş Örneği/Ordering Example/Образец заказа  
1 ad./pcs./шт. S25S TDQNR 11

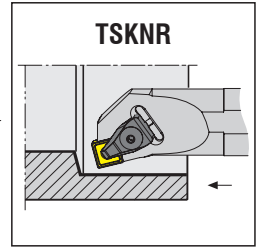
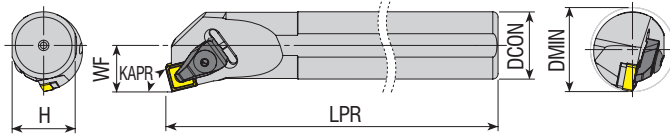

Takım Kodu Ordering Code Код для заказа	Stok Stock Наличие		Takım Ölçüleri (mm) Dimension (mm) Размеры (мм)					Kesici Uç Insert Пластина	Yedek Parçaları / Spare Parts / Запасные части						
	R	L	DCON	H	LPR	WF	DMIN		Baskı Pabucu Wedge Clamp Прижим	Pabuç Vidası Clamp Screw Зажимной винт	Altlık Shim Опорная пластина	Altlık Vidası Shim Screw Винт опорной пластины	Sekman Ring Кольцо	Pul Stamp Шайба	Anahtar Allen Key Ключ
	●	●													
S25S TSKNR/L 12	●	●	25	23	250	17	≥32	SNM. 1204..	ATK-02	AKV-30-M6x22	AASN-3-0004	AAV-13-M5x8	AS-01	ABPL-01	AAL-03-3
S32T TSKNR/L 12	●	●	32	30	300	22	≥40								
S40U TSKNR/L 12	●	●	40	37.5	350	27	≥50								

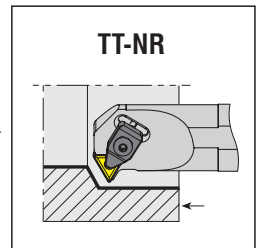
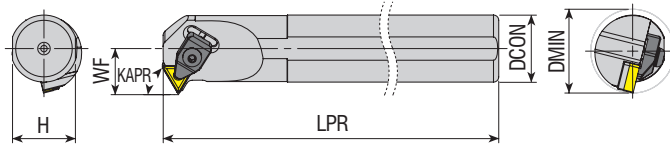
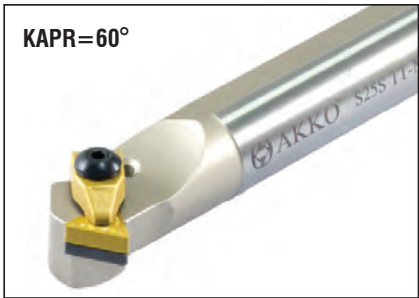

Takım Kodu Ordering Code Код для заказа	Stok Stock Наличие		Takım Ölçüleri (mm) Dimension (mm) Размеры (мм)					Kesici Uç Insert Пластина	Yedek Parçaları / Spare Parts / Запасные части						
	R	L	DCON	H	LPR	WF	DMIN		Baskı Pabucu Wedge Clamp Прижим	Pabuç Vidası Clamp Screw Зажимной винт	Altlık Shim Опорная пластина	Altlık Vidası Shim Screw Винт опорной пластины	Yay Spring Пружина	Pul Stamp Шайба	Anahtar Allen Key Ключ
	●	●													
S25S TT-NR/L 16	●	●	25	23	250	17	≥32	TNM. 1604..	ATK-01	AKV-01-M5x22	AATN-2-0002	AAV-03-M5x12	-	ABPL-01	AAL-03-3
S32T TT-NR/L 16	●	●	32	30	300	22	≥40								

R: Sağ / Right / Правый L: Sol / Left / Левый  
● Stokta / In Stock / В наличии ○ Stokta Yok / Non Stock Item / Нет в наличии

Sipariş Örneği/Ordering Example/Образец заказа  
1 ad./pcs./шт. S25S TSKNR 12

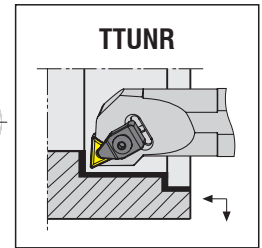
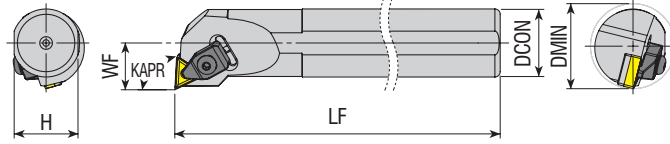

Takım Kodu Ordering Code Код для заказа	Stok Stock Наличие		Takım Ölçüleri (mm) Dimension (mm) Размеры (мм)					Kesici Uç Insert Пластина	Yedek Parçaları / Spare Parts / Запасные части						
	R	L	DCON	H	LF	WF	DMIN		Baskı Pabuçu Wedge Clamp Прижим	Pabuç Vidası Clamp Screw Зажимной винт	Altlık Shim Опорная пластина	Altlık Vidası Shim Screw Винт опорной пластины	Sekman Ring Кольцо	Pul Stamp Шайба	Anahtar Allen Key Ключ
S25S TTUNR/L 16	●	●	25	23	250	17	≥32	TNM. 1604..	ATK-01	AKV-01-M5x22	AATN-2-0002	AAV-03-M5x12	-	ABPL-01	AAL-03-3
S32T TTUNR/L 16	●	●	32	30	300	22	≥40								
S25S TTUNR/L 22	●	●	25	23	250	17	≥32	TNM. 2204..	ATK-02	AKV-30-M6x22	AATN-3-0015	AAV-02-M5x12	AS-01	ABPL-01	AAL-03-3
S32T TTUNR/L 22	●	●	32	30	300	22	≥40								
S40U TTUNR/L 22	●	●	40	37.5	350	27	≥50								
S50V TTUNR/L 22	●	●	50	47	400	35	≥63								

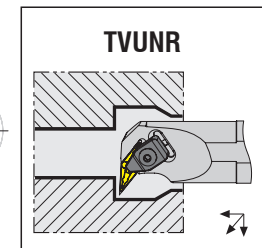
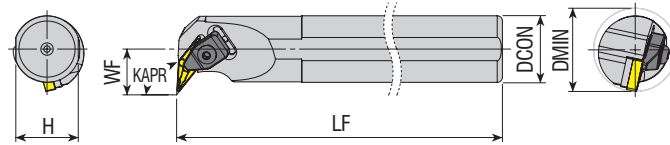

Takım Kodu Ordering Code Код для заказа	Stok Stock Наличие		Takım Ölçüleri (mm) Dimension (mm) Размеры (мм)					Kesici Uç Insert Пластина	Yedek Parçaları / Spare Parts / Запасные части						
	R	L	DCON	H	LF	WF	DMIN		Baskı Pabuçu Wedge Clamp Прижим	Pabuç Vidası Clamp Screw Зажимной винт	Altlık Shim Опорная пластина	Altlık Vidası Shim Screw Винт опорной пластины	Yay Spring Пружина	Pul Stamp Шайба	Anahtar Allen Key Ключ
S25S TVUNR/L 16	●	●	25	23	250	20	≥36	VNM. 1604..	ATK-01	AKV-01-M5x22	AAVN-2-0002	AAV-04-M5x12	-	ABPL-01	AAL-03-3
S32T TVUNR/L 16	●	●	32	30	300	22	≥40								
S40U TVUNR/L 16	●	●	40	37.5	350	27	≥50								

R: Sağ / Right / Правый L: Sol / Left / Левый  
● Stokta / In Stock / В наличии ○ Stokta Yok / Non Stock Item / Нет в наличии

Sipariş Örneği/Ordering Example/Образец заказа  
1 ad./pcs./шт. S25S TTUNR 16



T-SİSTEM DELİK TORNA KATERLERİ  
T-SYSTEM BORING BARS  
T-ТИП РАСТОЧНЫЕ ДЕРЖАВКИ

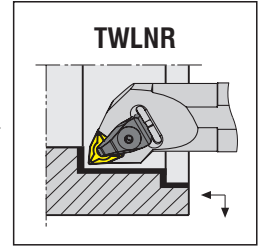
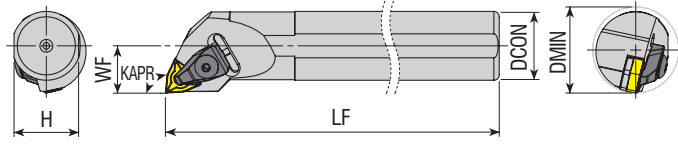

Yedek Parçaları / Spare Parts / Запасные части

Takım Kodu Ordering Code Код для заказа	Stok Stock Наличие		Takım Ölçüleri (mm) Dimension (mm) Размеры (мм)					Kesici Uç Insert Пластина	Baskı Pabuçu Wedge Clamp Прижим	Pabuç Vidası Clamp Screw Зажимной винт	Altlık Shim Опорная пластина	Altlık Vidası Shim Screw Винт опорной пластины	Sekman Ring Кольцо	Pul Stamp Шайба	Anahtar Allen Key Ключ
	R	L	DCON	H	LF	WF	DMIN								
S25S TWLNR/L 06	●	●	25	23	250	17	≥32	WNM. 0604..	ATK-01	AKV-01-M5x22	AAWN-SW317	AAV-01-M3x10	-		
S32T TWLNR/L 06	●	●	32	30	300	22	≥40					AAV-13-M5x8			
S25S TWLNR/L 08	●	●	25	23	250	17	≥32	WNM. 0804..	ATK-02	AKV-30-M6x22	AAWN-3-0001	AAV-02-M5x12	AS-01	ABPL-01	AAL-03-3
S32T TWLNR/L 08	●	●	32	30	300	22	≥40								
S40U TWLNR/L 08	●	●	40	37.5	350	27	≥50								
S50V TWLNR/L 08	●	●	50	47	400	35	≥63								
A40T TWLNR/L 08	●	○	40	37.5	300	27	≥50								
A50U TWLNR/L 08	●	○	50	47	350	35	≥63								

C-SİSTEM DELİK TORNA KATERLERİ  
C-SYSTEM BORING BARS  
C-ТИП РАСТОЧНЫЕ ДЕРЖАВКИ

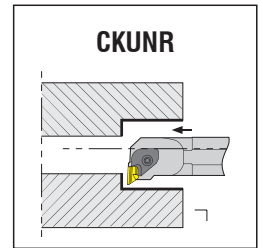
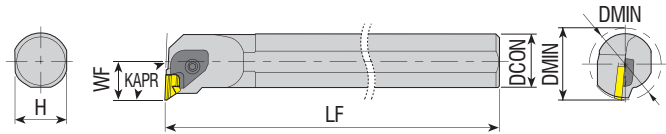

Yedek Parçaları / Spare Parts / Запасные части

Takım Kodu Ordering Code Код для заказа	Stok Stock Наличие		Takım Ölçüleri (mm) Dimension (mm) Размеры (мм)					Kesici Uç Insert Пластина	Baskı Pabuçu Wedge Clamp Прижим	Pabuç Vidası Clamp Screw Зажимной винт	Altlık Shim Опорная пластина	Altlık Vidası Shim Screw Винт опорной пластины	Yay Spring Пружина	Pul Stamp Шайба	Anahtar Allen Key Ключ
	R	L	DCON	H	LF	WF	DMIN								
S25S CKUNR/L 16	●	●	25	23	250	19	≥38	KNUX 1604..	ACK-01-R ACK-02-L	AKV-06-M6x20	AKS-16-R AKS-16-L	AAV-01-M3x10	AKY-02	ABPL-01	AAL-05-4
S32T CKUNR/L 16	●	●	32	30	300	22	≥40								
S40U CKUNR/L 16	●	●	40	37.5	350	27	≥50								
S50V CKUNR/L 16	●	●	50	47	400	35	≥63								

R: Sağ / Right / Правый L: Sol / Left / Левый

● Stokta / In Stock / В наличии ○ Stokta Yok / Non Stock Item / Нет в наличии

Sipariş Örneği/Ordering Example/Образец заказа

1 ad./pcs./шт. S25S TWLNR 06



# M-SİSTEM

M-SİSTEM DELİK TORNA KATERLERİ  
M-SYSTEM BORING BARS  
M-ТИП РАСТОЧНЫЕ ДЕРЖАВКИ

*konusulan  
the spoken kalite...  
quality...*



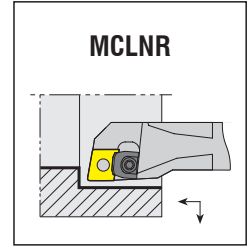
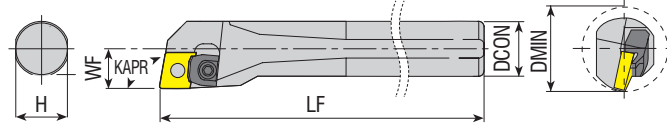

Takım Kodu Ordering Code Код для заказа	Stok Stock Наличие		Takım Ölçüleri (mm) Dimension (mm) Размеры (мм)					Kesici Uç Insert Пластина	Yedek Parçaları / Spare Parts / Запасные части					
	R	L	DCON	H	LF	WF	DMIN		Baskı Pabucu Wedge Clamp Прижим	Pabuç Vidası Clamp Screw Зажимной винт	Altlık Shim Опорная пластина	Pim Pin Штифт	Pul Stamp Шайба	Anahtar Allen Key Ключ
S20R MCLNR/L 12	●	●	20	18.3	200	13	≥25	CNM. 1204..	AMK-07	AKV-04-M5x17	AACN-3-0001	APM-12	-	AAL-03-3
S25S MCLNR/L 12	●	●	25	23	250	17	≥32		AMK-03			APM-13		
S32T MCLNR/L 12	●	●	32	30	300	22	≥40					APM-04		

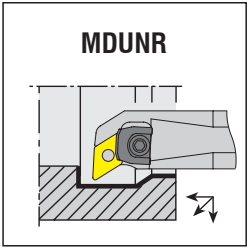
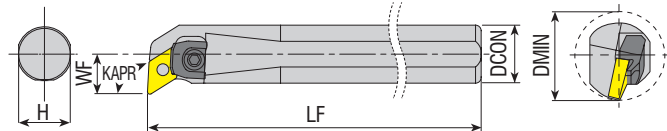
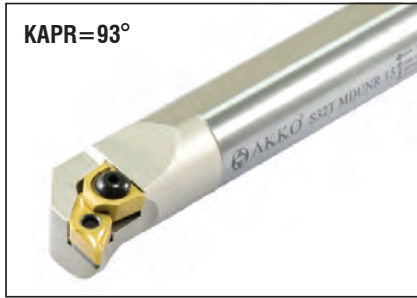

Takım Kodu Ordering Code Код для заказа	Stok Stock Наличие		Takım Ölçüleri (mm) Dimension (mm) Размеры (мм)					Kesici Uç Insert Пластина	Yedek Parçaları / Spare Parts / Запасные части						
	R	L	DCON	H	LF	WF	DMIN		Baskı Pabucu Wedge Clamp Прижим	Pabuç Vidası Clamp Screw Зажимной винт	Altlık Shim Опорная пластина	Pim Pin Штифт	Sekman Ring Кольцо	Pul Stamp Шайба	Anahtar Allen Key Ключ
S20R MDUNR/L 11	●	●	20	18.3	200	13	≥25	DNM. 1104..	AMK-03	AKV-17-M5x15	-	APM-03	-	-	AAL-03-3
S25S MDUNR/L 11	●	●	25	23	250	17	≥32			AKV-04-M5x17					
S32T MDUNR/L 11	○	○	32	30	300	22	≥40								
S25S MDUNR/L 15	●	●	25	23	250	17	≥32	DNM. 1506..	AMK-04	AKV-20-M6x19	AADN-3-0001	APM-04	AS-01	ABPL-01	
S32T MDUNR/L 15	●	●	32	30	300	22	≥40			AKV-30-M6x22					
S40U MDUNR/L 15	●	●	40	37.5	350	27	≥50								
S50V MDUNR/L 15	●	●	50	47	400	35	≥63								

R: Sağ / Right / Правый L: Sol / Left / Левый  
● Stokta / In Stock / В наличии ○ Stokta Yok / Non Stock Item / Нет в наличии

Sipariş Örneği/Ordering Example/Образец заказа  
1 ad./pcs./шт. S20R MCLNR 12

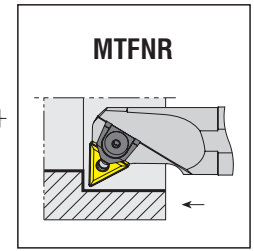
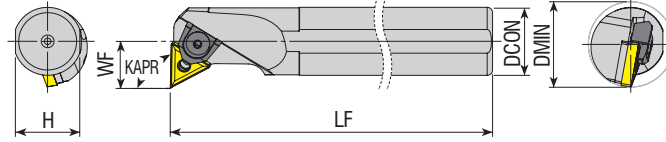
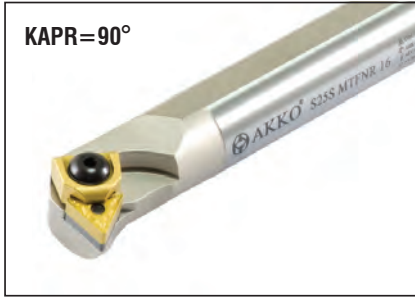

Takım Kodu Ordering Code Код для заказа	Stok Stock Наличие		Takım Ölçüleri (mm) Dimension (mm) Размеры (мм)				Kesici Uç Insert Пластина	Baskı Pabucu Wedge Clamp Прижим	Pabuç Vidası Clamp Screw Зажимной винт	Altlık Shim Опорная пластина	Pim Pin Штифт	Sekman Ring Кольцо	Pul Stamp Шайба	Anahtar Allen Key Ключ	
	R	L	DCON	H	LF	WF									DMIN
S20R MTFNR/L 16	●	●	20	18.3	200	14	≥25	TNM. 1604..	AMK-02	AKV-17-M5x15	-	APM-03	-	-	AAL-03-3
S25S MTFNR/L 16	●	●	25	23	250	17	≥32		AMK-04	AKV-30-M6x22	AATN-2-0002	APM-14	AS-01	ABPL-01	
S32T MTFNR/L 16	●	●	32	30	300	22	≥40				AATN-3-0015	APM-01			
S40U MTFNR/L 16	●	●	40	37.5	350	27	≥50								
S32T MTFNR/L 22	●	●	32	30	300	22	≥40	TNM. 2204..	AMK-04	AKV-30-M6x22	AATN-3-0015	APM-02	ABPL-01	AAL-03-3	
S40U MTFNR/L 22	●	●	40	37.5	350	27	≥50								
S50V MTFNR/L 22	●	○	50	47	400	35	≥63								

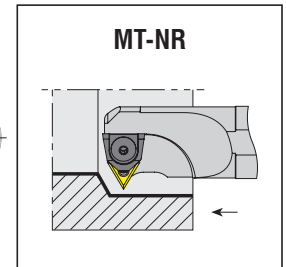
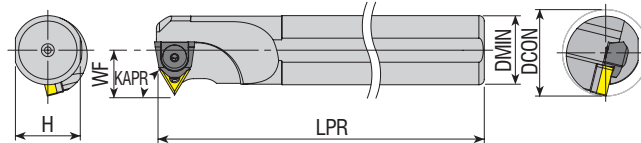

Takım Kodu Ordering Code Код для заказа	Stok Stock Наличие		Takım Ölçüleri (mm) Dimension (mm) Размеры (мм)				Kesici Uç Insert Пластина	Baskı Pabucu Wedge Clamp Прижим	Pabuç Vidası Clamp Screw Зажимной винт	Altlık Shim Опорная пластина	Pim Pin Штифт	Sekman Ring Кольцо	Pul Stamp Шайба	Anahtar Allen Key Ключ				
	R	L	DCON	H	LPR	WF									DMIN			
S20R MT-NR/L 16	●	●	20	18.3	200	16	≥26	TNM. 1604..	AMK-02	AKV-04-M5x17	-	APM-03	-	-	AAL-03-3			
S25S MT-NR/L 16	●	●	25	23	250	17	≥32					AATN-2-0002				APM-14		
S32T MT-NR/L 16	●	●	32	30	300	22	≥40									AATN-3-0015	APM-01	AS-01
S40U MT-NR/L 16	●	●	40	37.5	350	27	≥50											
S32T MT-NR/L 22	●	●	32	30	300	24	≥40	TNM. 2204..	AMK-04	AKV-30-M6x22	AATN-3-0015	APM-02	ABPL-01	AAL-03-3				
S40U MT-NR/L 22	●	●	40	37.5	350	27	≥50											
S50U MT-NR/L 22	●	●	50	47	350	35	≥63											

R: Sağ / Right / Правый L: Sol / Left / Левый  
● Stokta / In Stock / В наличии ○ Stokta Yok / Non Stock Item / Нет в наличии

Sipariş Örneği/Ordering Example/Образец заказа  
1 ad./pcs./шт. S20R MTFNR 16

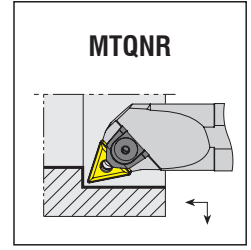
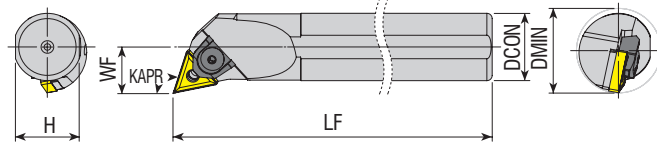

Takım Kodu Ordering Code Код для заказа	Stok Stock Наличие		Takım Ölçüleri (mm) Dimension (mm) Размеры (мм)					Kesici Uç Insert Пластина	Yedek Parçaları / Spare Parts / Запасные части						
	R	L	DCON	H	LF	WF	DMIN		Baskı Pabucu Wedge Clamp Прижим	Pabuç Vidası Clamp Screw Зажимной винт	Aitlik Shim Опорная пластина	Pim Pin Штифт	Sekman Ring Кольцо	Pul Stamp Шайба	Anahtar Allen Key Ключ
S20R MTQNR/L 16	●	●	20	18.3	200	13	≥25	TNM. 1604..	AMK-02	AKV-17-M5x15	-	APM-11	-	-	
S25S MTQNR/L 16	●	●	25	23	250	17	≥32				AATN-2-0002	APM-14			
S32T MTQNR/L 16	●	●	32	30	300	22	≥40					APM-01			
S40U MTQNR/L 16	●	●	40	37.5	350	27	≥50	TNM. 2204..	AMK-04	AKV-30-M6x22			AS-01	ABPL-01	AAL-03-3
S32T MTQNR/L 22	●	●	32	30	300	22	≥40				AATN-3-0015	APM-02			
S40U MTQNR/L 22	●	●	40	37.5	350	27	≥50								
S50V MTQNR/L 22	●	●	50	47	400	35	≥63								

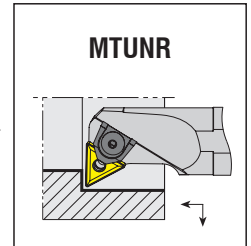
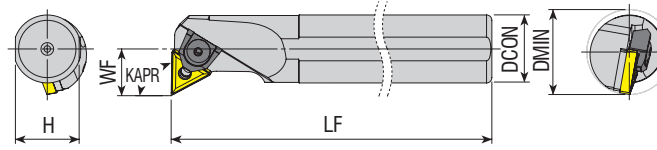

Takım Kodu Ordering Code Код для заказа	Stok Stock Наличие		Takım Ölçüleri (mm) Dimension (mm) Размеры (мм)					Kesici Uç Insert Пластина	Yedek Parçaları / Spare Parts / Запасные части						
	R	L	DCON	H	LF	WF	DMIN		Baskı Pabucu Wedge Clamp Прижим	Pabuç Vidası Clamp Screw Зажимной винт	Aitlik Shim Опорная пластина	Pim Pin Штифт	Sekman Ring Кольцо	Pul Stamp Шайба	Anahtar Allen Key Ключ
S20R MTUNR/L 16	●	●	20	18.3	200	13	≥25	TNM. 1604..	AMK-02	AKV-17-M5x15	-	APM-03	-	-	
S25S MTUNR/L 16	●	●	25	23	250	17	≥32				AATN-2-0002	APM-14			
S32T MTUNR/L 16	●	●	32	30	300	22	≥40					APM-01			
S40U MTUNR/L 16	●	●	40	37.5	350	27	≥50	TNM. 2204..	AMK-04	AKV-30-M6x22			AS-01	ABPL-01	AAL-03-3
S50V MTUNR/L 16	●	●	50	47	400	35	≥63				AATN-3-0015	APM-02			
S32T MTUNR/L 22	●	●	32	30	300	22	≥40								
S40U MTUNR/L 22	●	●	40	37.5	350	27	≥50								
S50V MTUNR/L 22	●	●	50	47	400	35	≥63								

R: Sağ / Right / Правый L: Sol / Left / Левый  
● Stokta / In Stock / В наличии ○ Stokta Yok / Non Stock Item / Нет в наличии

Sipariş Örneği/Ordering Example/Образец заказа  
1 ad./pcs./шт. S20R MTQNR 16

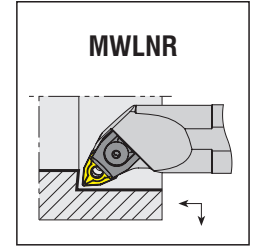
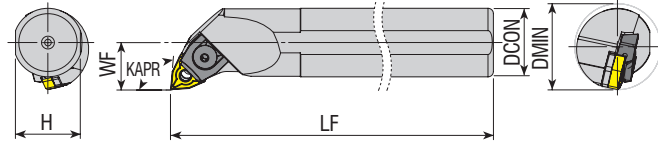

Takım Kodu Ordering Code Код для заказа	Stok Stock Наличие		Takım Ölçüleri (mm) Dimension (mm) Размеры (мм)				Kesici Uç Insert Пластина	Baskı Pabuçu Wedge Clamp Прижим	Pabuç Vidası Clamp Screw Зажимной винт	Altlık Shim Оторная пластина	Pim Pin Штифт	Sekman Ring Кольцо	Pul Stamp Шайба	Anahtar Allen Key Ключ	
	R	L	DCON	H	LF	WF									DMIN
S16P MWLNR/L 06	●	●	16	14.8	170	11	≥20	WNM. 0604..	AMK-01	AKV-17-M5x15	-	APM-09	-	-	AAL-03-3
S20R MWLNR/L 06	●	●	20	18.3	200	13	≥25			AKV-04-M5x17		APM-10			
S25S MWLNR/L 06	●	●	25	23	250	17	≥32			AKV-27-M6x20		APM-08			
S25S MWLNR/L 08	●	●	25	23	250	17	≥32	WNM. 0804..	AMK-05	AKV-03-M6x22	AAWN-3-0001	APM-04	AS-01	ABPL-01	
S32T MWLNR/L 08	●	●	32	30	300	22	≥40			APM-02					
S40U MWLNR/L 08	●	●	40	37.5	350	27	≥50								

R: Sağ / Right / Правый L: Sol / Left / Левый

● Stokta / In Stock / В наличии ○ Stokta Yok / Non Stock Item / Нет в наличии

Sipariş Örneği/Ordering Example/Образец заказа

1 ad./pcs./шт. S16P MWLNR 06





*konusulan  
the spoken kalite...  
quality...*

# P-SİSTEM

**P-SİSTEM DELİK TORNA KATERLERİ**  
P-SYSTEM BORING BARS  
P-ТИП РАСТОЧНЫЕ ДЕРЖАВКИ



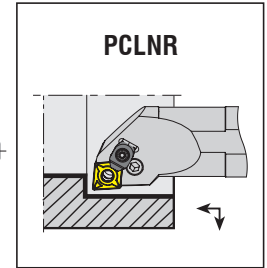
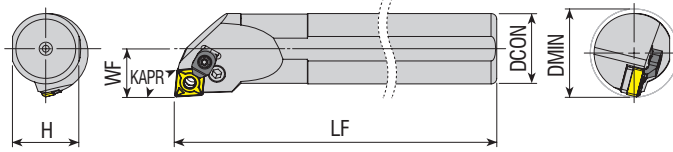

Takım Kodu Ordering Code Код для заказа	Stok Stock Наличие		Takım Ölçüleri (mm) Dimension (mm) Размеры (мм)					Kesici Uç Insert Пластина	Yedek Parçaları / Spare Parts / Запасные части						
	R	L	DCON	H	LF	WF	DMIN		Levyeye Lever Рычаг	Levyeye Vidası Lever Screw Винт рычага	Altılık Shim Опорная пластина	Altılık Yayı Shim Spring Втулка рычага	Baskı Pabuçu Wedge Clamp Прижим	Pabuç Vidası Clamp Screw Зажимной винт	Anahtar Allen Key Ключ
<b>S16P PCLNR/L 09</b>	●	●	16	14.8	170	11	≥20	<b>CNM. 0903..</b>	APL-07	ALV-07-M6x13	-	AAV-07	-	-	AAL-02-2.5
<b>S20R PCLNR/L 09</b>	●	●	20	18.3	200	13	≥25		APL-01	ALV-02-M6x17	AACN-2-0002	AAV-01	-	-	AAL-02-2.5
<b>S25S PCLNR/L 09</b>	●	○	25	23	250	17	≥32			ALV-08-M8x16					
<b>S25S PCLNR/L 12C</b>	●	●	25	23	250	17	≥32	<b>CNM. 1204..</b>	APL-02	ALV-03-M8x19	AACN-3-0001	AAV-02	ACK-05	4015-M4x11	AAL-03-3
<b>S32T PCLNR/L 12C</b>	●	●	32	30	300	22	≥40								
<b>S40U PCLNR/L 12C</b>	●	●	40	37.5	350	27	≥50								
<b>S50V PCLNR/L 12C</b>	●	●	50	47	400	35	≥63	<b>CNM. 1606..</b>	APL-04	ALV-04-M8x22	AACN-3-0002	AAV-03	ACK-09	AAV-05-M6x15	AAL-05-4
<b>S32T PCLNR/L 16C</b>	●	●	32	30	300	22	≥40								
<b>S40U PCLNR/L 16C</b>	●	●	40	37.5	350	27	≥50								
<b>S50V PCLNR/L 16C</b>	●	●	50	47	400	35	≥63	<b>CNM. 1906..</b>	APL-05	ALV-05-M10x27	AACN-3-0003	AAV-04	ACK-09	AAV-05-M6x15	AAL-05-4
<b>S40U PCLNR/L 19C</b>	●	●	40	37.5	350	27	≥50								
<b>S50V PCLNR/L 19C</b>	●	●	50	47	400	35	≥63								
<b>A20P PCLNR/L 09</b>	●	●	20	18.3	170	13	≥25	<b>CNM. 0903..</b>	APL-01	ALV-02-M6x17	AACN-2-0002	AAV-01	-	-	AAL-02-2.5
<b>A25R PCLNR/L 12C</b>	●	●	25	23	200	17	≥32								
<b>A32S PCLNR/L 12C</b>	●	●	32	30	250	22	≥40								
<b>A40T PCLNR/L 12C</b>	●	●	40	37.5	300	27	≥50	<b>CNM. 1204..</b>	APL-02	ALV-03-M8x19	AACN-3-0001	AAV-02	ACK-05	4015-M4x11	AAL-03-3
<b>A50U PCLNR/L 12C</b>	●	●	50	47	350	35	≥63								
<b>A32S PCLNR/L 16C</b>	●	●	32	30	250	22	≥40								
<b>A40T PCLNR/L 16C</b>	●	●	40	37.5	300	27	≥50	<b>CNM. 1606..</b>	APL-04	ALV-04-M8x22	AACN-3-0002	AAV-03	ACK-09	AAV-05-M6x15	AAL-05-4
<b>A50U PCLNR/L 16C</b>	●	●	50	47	350	35	≥63								
<b>A40T PCLNR/L 19C</b>	●	●	40	37.5	300	27	≥50								
<b>A50U PCLNR/L 19C</b>	●	●	50	47	350	35	≥63	<b>CNM. 1906..</b>	APL-05	ALV-05-M10x27	AACN-3-0003	AAV-04	ACK-09	AAV-05-M6x15	AAL-05-4
<b>A40T PCLNR/L 19C</b>	●	●	40	37.5	300	27	≥50								
<b>A50U PCLNR/L 19C</b>	●	●	50	47	350	35	≥63								

R: Sağ / Right / Правый L: Sol / Left / Левый

● Stokta / In Stock / В наличии ○ Stokta Yok / Non Stock Item / Нет в наличии

Sipariş Örneği/Ordering Example/Образец заказа

1 ad./pcs./шт. S16P PCLNR 09



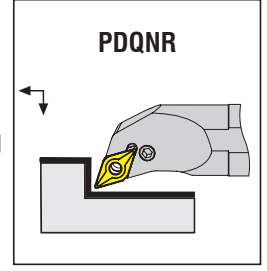
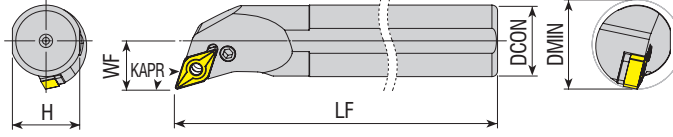

Takım Kodu Ordering Code Код для заказа	Stok Stock Наличие		Takım Ölçüleri (mm) Dimension (mm) Размеры (мм)					Kesici Uç Insert Пластина	Yedek Parçaları / Spare Parts / Запасные части						
	R	L	DCON	H	LF	WF	DMIN		Levyeye Lever Рычаг	Levyeye Vidası Lever Screw Винт рычага	Altılık Shim Опорная пластина	Altılık Yayı Shim Spring Втулка рычага	Baskı Pabuçu Wedge Clamp Прижим	Pabuç Vidası Clamp Screw Зажимной винт	Anahtar Allen Key Ключ
	●	○													
S20R PDQNR/L 11	●	○	20	18.3	200	13	≥25	DNM. 1104..	APL-01	ALV-01-M6x14 ALV-02-M6x17	AADN-SD317	AAY-01			AAL-02-2.5
S25S PDQNR/L 11	●	●	25	23	250	17	≥32								
S32T PDQNR/L 15	●	●	32	30	300	22	≥40	DNM. 1506..	APL-03	ALV-03-M8x19	AADN-3-0001	AAY-02	-	-	AAL-03-3
S40U PDQNR/L 15	●	●	40	37.5	350	27	≥50								
S50V PDQNR/L 15	●	●	50	47	400	35	≥63	DNM. 1504..	APL-03	ALV-03-M8x19	AADN-2-0003	AAY-02	-	-	AAL-03-3
S32T PDQNR/L 1504	●	●	32	30	300	22	≥40								
S40U PDQNR/L 1504	●	●	40	37.5	350	27	≥50	DNM. 1104..	APL-01	ALV-01-M6x14 ALV-02-M6x17	AADN-SD317	AAY-01	-	-	AAL-02-2.5
S50V PDQNR/L 1504	●	●	50	47	400	35	≥63								
A20P PDQNR/L 11	●	●	20	18.3	170	13	≥25	DNM. 1506..	APL-03	ALV-03-M8x19	AADN-3-0001	AAY-02	-	-	AAL-03-3
A25R PDQNR/L 11	●	●	25	23	200	17	≥32								
A32S PDQNR/L 15	●	●	32	30	250	22	≥40	DNM. 1504..	APL-03	ALV-03-M8x19	AADN-2-0003	AAY-02	-	-	AAL-03-3
A40T PDQNR/L 15	●	●	40	37.5	300	27	≥50								
A50U PDQNR/L 15	●	●	50	47	350	35	≥63	DNM. 1506..	APL-03	ALV-03-M8x19	AADN-3-0001	AAY-02	-	-	AAL-03-3
A32S PDQNR/L 1504	●	●	32	30	250	22	≥40								
A40T PDQNR/L 1504	●	●	40	37.5	300	27	≥50								

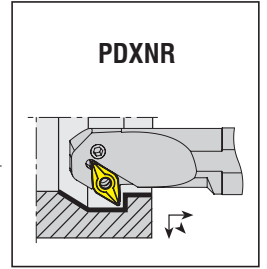
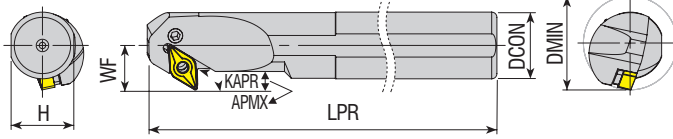

Takım Kodu Ordering Code Код для заказа	Stok Stock Наличие		Takım Ölçüleri (mm) Dimension (mm) Размеры (мм)					Kesici Uç Insert Пластина	Yedek Parçaları / Spare Parts / Запасные части							
	R	L	DCON	H	LPR	WF	APMX		DMIN	Levyeye Lever Рычаг	Levyeye Vidası Lever Screw Винт рычага	Altılık Shim Опорная пластина	Altılık Yayı Shim Spring Втулка рычага	Baskı Pabuçu Wedge Clamp Прижим	Pabuç Vidası Clamp Screw Зажимной винт	Anahtar Allen Key Ключ
	●	○														
S32T PDXNR/L 15	●	●	32	30	300	22	12	≥45	DNM. 1506..	APL-03	ALV-08-M8x16 ALV-03-M8x19 ALV-08-M8x16 ALV-03-M8x19	AADN-3-0001	AAY-02	-	-	AAL-03-3
S40U PDXNR/L 15	●	●	40	37.5	350	27	14	≥50								
S50V PDXNR/L 15	●	●	50	47	400	35	19	≥63								
A32S PDXNR/L 15	●	●	32	30	250	22	12	≥40								
A40T PDXNR/L 15	●	●	40	37.5	300	27	14	≥50								
A50U PDXNR/L 15	●	●	50	47	350	35	19	≥63								

R: Sağ / Right / Правый L: Sol / Left / Левый

● Stokta / In Stock / В наличии ○ Stokta Yok / Non Stock Item / Нет в наличии

Not: "APMX" ölçüleri R0.8'e göre verilmiştir. Note: Dimensions of "APMX" are given according to R0.8. Примечание: размеры должны быть R.08

Sipariş Örneği/Ordering Example/Образец заказа

1 ad./pcs./шт. S20R PDQNR 11

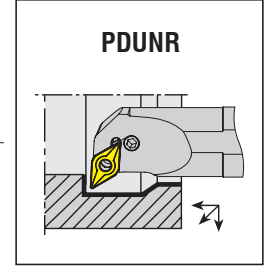
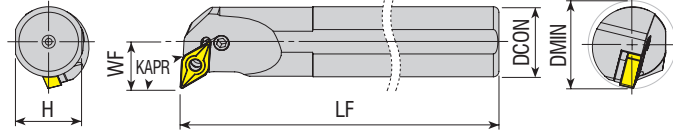

Takım Kodu Ordering Code Код для заказа	Stok Stock Наличие		Takım Ölçüleri (mm) Dimension (mm) Размеры (мм)					Kesici Uç Insert Пластина	Yedek Parçaları / Spare Parts / Запасные части						
	R	L	DCON	H	LF	WF	DMIN		Leyve Lever Рычаг	Leyve Vidası Lever Screw Винт рычага	Altlık Shim Опорная пластина	Altlık Yay Shim Spring Втулка рычага	Baskı Pabuç Wedge Clamp Прижим	Pabuç Vidası Clamp Screw Зажимной винт	Anahtar Allen Key Ключ
	●	○													
S20R PDUNR/L 11	●	●	20	18.3	200	13	≥25	DNM. 1104..	APL-01	ALV-01-M6x14 ALV-02-M6x17 ALV-08-M8x16	AADN-SD317	AAY-01	-	-	AAL-02-2.5
S25S PDUNR/L 11	●	●	25	23	250	17	≥32								
S25S PDUNR/L 15	●	●	25	23	250	19	≥32								
S32T PDUNR/L 15	●	●	32	30	300	22	≥40	DNM. 1506..	APL-03	ALV-03-M8x19	AADN-3-0001	AAY-02	-	-	AAL-03-3
S40U PDUNR/L 15	●	●	40	37.5	350	27	≥50								
S50V PDUNR/L 15	●	●	50	47	400	35	≥63								
A20P PDUNR/L 11	●	●	20	18.3	170	13	≥25	DNM. 1104..	APL-01	ALV-01-M6x14 ALV-02-M6x17	AADN-SD317	AAY-01	-	-	AAL-02-2.5
A25R PDUNR/L 11	●	●	25	23	200	17	≥32								
A32S PDUNR/L 11	●	●	32	30	250	22	≥40								
A32S PDUNR/L 15	●	●	32	30	250	22	≥40	DNM. 1506..	APL-03	ALV-03-M8x19	AADN-3-0001	AAY-02	-	-	AAL-03-3
A40T PDUNR/L 15	●	●	40	37.5	300	27	≥50								
A50U PDUNR/L 15	●	●	50	47	350	35	≥63								

R: Sağ / Right / Правый L: Sol / Left / Левый

● Stokta / In Stock / В наличии ○ Stokta Yok / Non Stock Item / Нет в наличии

Sipariş Örneği/Ordering Example/Образец заказа  
1 ad./pcs./шт. S20R PDUNR 11



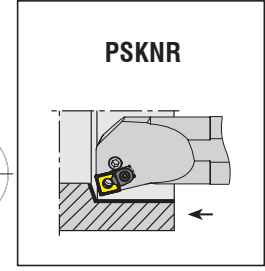
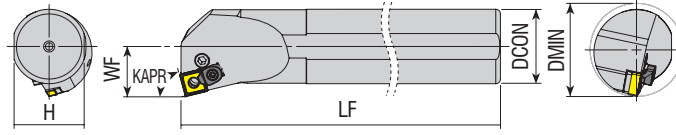

Takım Kodu Ordering Code Код для заказа	Stok Stock Наличие		Takım Ölçüleri (mm) Dimension (mm) Размеры (мм)					Kesici Uç Insert Пластина	Yedek Parçaları / Spare Parts / Запасные части						
	R	L	DCON	H	LF	WF	DMIN		Levyeye Lever Рычаг	Levyeye Vidası Lever Screw Винт рычага	Altılık Shim Опорная пластина	Altılık Yayılı Shim Spring Втулка рычага	Baskı Pabuçlu Wedge Clamp Прижим	Pabuç Vidası Clamp Screw Зажимный винт	Anahtar Allen Key Ключ
S25S PSKNR/L 12C	●	●	25	23	250	17	≥32	SNM. 1204..	APL-02	ALV-08-M8x16	AASN-3-0004	AAY-02	ACK-05	4015-M4x11	AAL-03-3
S32T PSKNR/L 12C	●	●	32	30	300	22	≥40								
S40U PSKNR/L 12C	●	●	40	37.5	350	27	≥50								
S50V PSKNR/L 12C	●	●	50	47	400	35	≥63								
S32T PSKNR/L 15C	○	○	32	30	300	22	≥40	SNM. 1506..	APL-04	ALV-04-M8x22	AASN-3-0023	AAY-03	ACK-09	AAV-05-M6x15	
S40U PSKNR/L 15C	○	●	40	37.5	350	27	≥50								
S50V PSKNR/L 15C	○	○	50	47	400	35	≥63								
A25R PSKNR/L 12C	●	●	25	23	200	17	≥32	SNM. 1204..	APL-02	ALV-08-M8x16	AASN-3-0004	AAY-02	ACK-05	4015-M4x11	
A32S PSKNR/L 12C	●	●	32	30	250	22	≥40								
A40T PSKNR/L 12C	●	●	40	37.5	300	27	≥50								
A50U PSKNR/L 12C	○	●	50	47	350	35	≥63								
A32S PSKNR/L 15C	●	●	32	30	250	22	≥40	SNM. 1506..	APL-04	ALV-04-M8x22	AASN-3-0023	AAY-03	ACK-09	AAV-05-M6x15	
A40T PSKNR/L 15C	●	●	40	37.5	300	27	≥50								
A50U PSKNR/L 15C	●	●	50	47	350	35	≥63								

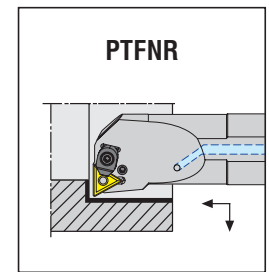
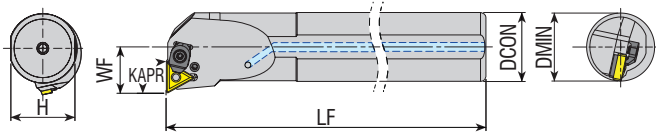
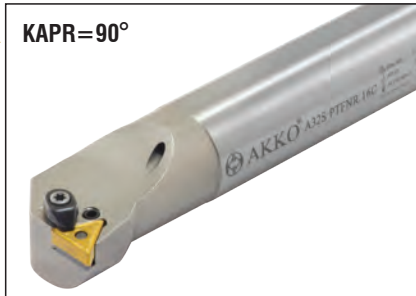

Takım Kodu Ordering Code Код для заказа	Stok Stock Наличие		Takım Ölçüleri (mm) Dimension (mm) Размеры (мм)					Kesici Uç Insert Пластина	Yedek Parçaları / Spare Parts / Запасные части						
	R	L	DCON	H	LF	WF	DMIN		Levyeye Lever Рычаг	Levyeye Vidası Lever Screw Винт рычага	Altılık Shim Опорная пластина	Altılık Yayılı Shim Spring Втулка рычага	Baskı Pabuçlu Wedge Clamp Прижим	Pabuç Vidası Clamp Screw Зажимный винт	Anahtar Allen Key Ключ
A25R PTFNR/L 16C	●	●	25	23	200	17	≥32	TNM. 1604..	APL-01	ALV-02-M6x17	AATN-3-0025	AAY-01	ACK-05	4015-M4x11	AAL-03-3
A32S PTFNR/L 16C	●	●	32	30	250	22	≥40								

R: Sağ / Right / Правый L: Sol / Left / Левый  
● Stokta / In Stock / В наличии ○ Stokta Yok / Non Stock Item / Нет в наличии

Sipariş Örneği/Ordering Example/Образец заказа  
1 ad./pcs./шт. S25S PSKNR 12C

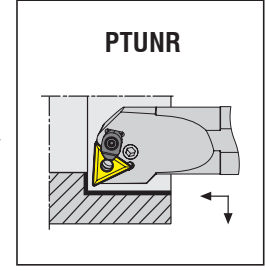
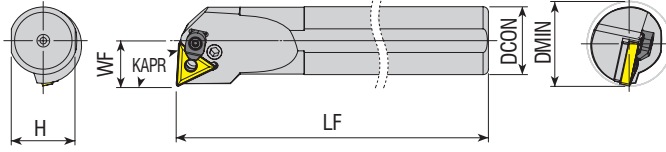

Takım Kodu Ordering Code Код для заказа	Stok Stock Наличие		Takım Ölçüleri (mm) Dimension (mm) Размеры (мм)				Kesici Uç Insert Пластина	Yedek Parçaları / Spare Parts / Запасные части																	
	R	L	DCON	H	LF	WF		DMIN	Leyve Lever Рычаг	Leyve Vidası Lever Screw Виты рычага	Altlık Shim Опорная пластина	Altlık Yayı Shim Spring Втулка рычага	Baskı Pabuçu Wedge Clamp Прижим	Pabuç Vidası Clamp Screw Зажимной винт	Anahtar Allen Key Ключ										
S16P PTUNR/L 16	●	●	16	14.8	170	11	≥20	TNM. 1604..	APL-08	ALV-07-M6x13	-	AAV-07	-	-	AAL-02-2.5										
S20R PTUNR/L 16	●	●	20	18.3	200	13	≥25		APL-01	ALV-01-M6x14	AATN-3-0025	AAV-01	ACK-05	4015-M4x11											
S25S PTUNR/L 16C	●	●	25	23	250	17	≥32			ALV-02-M6x17						AATN-3-0015	AAV-02	ACK-05	4015-M4x11						
S32T PTUNR/L 16C	●	●	32	30	300	22	≥40													APL-02	ALV-03-M8x19	AATN-3-0015	AAV-02	ACK-05	4015-M4x11
S40U PTUNR/L 16C	●	●	40	37.5	350	27	≥50																		
S32T PTUNR/L 22C	●	●	32	30	300	22	≥40	APL-08	ALV-07-M6x13	-	AAV-07	-	-												
S40U PTUNR/L 22C	●	●	40	37.5	350	27	≥50							TNM. 1604..	APL-01	ALV-02-M6x17	AATN-3-0025	AAV-01	ACK-05	4015-M4x11					
S50V PTUNR/L 22C	●	●	50	47	400	35	≥63	APL-02	ALV-03-M8x19	AATN-3-0015	AAV-02	ACK-05	4015-M4x11												
A16M PTUNR/L 16	●	●	16	14.8	150	11	≥20														TNM. 2204..	ALV-03-M8x19	AATN-3-0015	AAV-02	ACK-05
A20P PTUNR/L 16	●	●	20	18.3	170	13	≥25	APL-01	ALV-02-M6x17	AATN-3-0025	AAV-01	ACK-05	4015-M4x11												
A25R PTUNR/L 16C	●	●	25	23	200	17	≥32							TNM. 1604..	AATN-3-0025	AAV-01	ACK-05	4015-M4x11							
A32S PTUNR/L 16C	●	●	32	30	250	22	≥40												APL-02	ALV-03-M8x19	AATN-3-0015	AAV-02	ACK-05	4015-M4x11	
A40T PTUNR/L 16C	●	●	40	37.5	300	27	≥50																		TNM. 2204..
A32S PTUNR/L 22C	●	●	32	30	250	22	≥40	APL-08	ALV-07-M6x13	-	AAV-07	-	-												
A40T PTUNR/L 22C	●	●	40	37.5	300	27	≥50							TNM. 1604..	APL-01	ALV-02-M6x17	AATN-3-0025	AAV-01	ACK-05	4015-M4x11					

R: Sağ / Right / Правый L: Sol / Left / Левый  
● Stokta / In Stock / В наличии ○ Stokta Yok / Non Stock Item / Нет в наличии

Sipariş Örneği/Ordering Example/Образец заказа  
1 ad./pcs./шт. S16P PTUNR 16



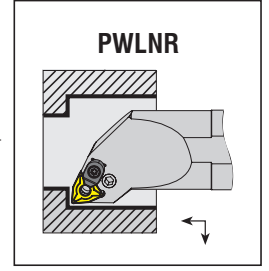
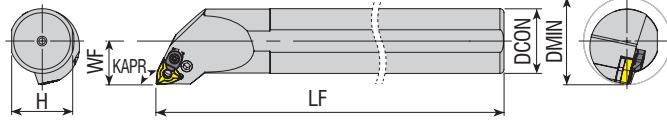

Takım Kodu Ordering Code Код для заказа	Stok Stock Наличие		Takım Ölçüleri (mm) Dimension (mm) Размеры (мм)				Kesici Uç Insert Пластина	Yedek Parçaları / Spare Parts / Запасные части							
	R	L	DCON	H	LF	WF		DMIN	Levyeye Lever Рычаг	Levyeye Vidası Lever Screw Винт рычага	Altılık Shim Отверная пластина	Altılık Yayılı Shim Spring Втулка рычага	Baskı Pabuçu Wedge Clamp Прижим	Pabuç Vidası Clamp Screw Зажимной винт	Anahtar Allen Key Ключ
S20R PwLNR/L 06	●	●	20	18.3	200	13	≥25	WNM. 0604..	APL-01	ALV-01-M6x14	AAWN-SW317	AAAY-01	-	-	AAL-02-2.5
S25S PwLNR/L 06	●	●	25	23	250	17	≥32			ALV-02-M6x17					
S32T PwLNR/L 06	●	●	32	30	300	22	≥40								
S25S PwLNR/L 08C	●	●	25	23	250	17	≥32								
S32T PwLNR/L 08C	●	●	32	30	300	22	≥40	WNM. 0804..	APL-02	ALV-03-M8x19	AAWN-3-0001	AAAY-02	ACK-05	4015-M4x11	AAL-03-3
S40U PwLNR/L 08C	●	●	40	37.5	350	27	≥50								
S50V PwLNR/L 08C	●	●	50	47	400	35	≥63								
A16M PwLNR/L 06	●	●	16	14.8	150	11	≥20	WNM. 0604..	APL-08	ALV-07-M6x13	-	AAAY-07	-	-	AAL-02-2.5
A20P PwLNR/L 06	●	●	20	18.3	170	13	≥25			ALV-01-M6x14					
A25R PwLNR/L 06	●	●	25	23	200	17	≥32		APL-01	ALV-02-M6x17	AAWN-SW317	AAAY-01			
A32S PwLNR/L 06	●	●	32	30	250	22	≥40								
A40T PwLNR/L 06C	●	○	40	37.5	300	27	≥50	WNM. 0804..	APL-02	ALV-03-M8x19	AAWN-3-0001	AAAY-02	ACK-05	4015-M4x11	AAL-03-3
A25R PwLNR/L 08C	●	●	25	23	200	17	≥32								
A32S PwLNR/L 08C	●	●	32	30	250	22	≥40								
A40T PwLNR/L 08C	●	●	40	37.5	300	27	≥50								
A50U PwLNR/L 08C	●	●	50	47	350	35	≥63								

R: Sağ / Right / Правый L: Sol / Left / Левый  
● Stokta / In Stock / В наличии ○ Stokta Yok / Non Stock Item / Нет в наличии

Sipariş Örneği/Ordering Example/Образец заказа  
1 ad./pcs./шт. S20R PwLNR 06



*konusulan  
the spoken kalite...  
quality...*

# S-SİSTEM

**S-SİSTEM DELİK TORNA KATERLERİ**  
S-SYSTEM BORING BARS  
S-ТИП РАСТОЧНЫЕ ДЕРЖАВКИ





KAPR=95°

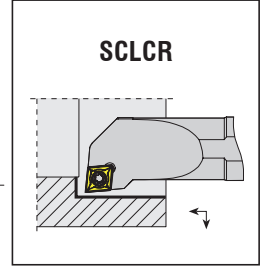
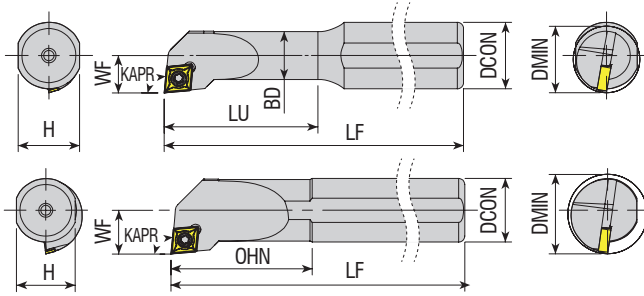

SCLCR

Takım Kodu Ordering Code Код для заказа	Stok Stock Наличие	Takım Ölçüleri (mm) Dimension (mm) Размеры (мм)								Kesici Uç Insert Пластина	Yedek Parçaları / Spare Parts / Запасные части			
		R	L	DCON	BD	H	LU=OHN	LF	WF		DMIN	Sıkma Vidası Screw Зажимной винт	Altlık Shim Опорная пластина	Altlık Vidası Shim Screw Винт опорной пластины
S0608H SCLCR/L 03	● ○	08	5	7.3	18	100	3	≥6	CC.T 030102	4006-M1.6x3.2 4008-M2.5x4.5			80-T06	
S0608H SCLCR/L 06	● ●	08	6	7.3	25	100	4.5	≥8						
S08H SCLCR/L 06	● ●	08	8	7.3	20	100	06	≥11						
S10K SCLCR/L 06	● ●	10	10	09	25	125	07	≥13						
S12K SCLCR/L 06	● ●	12	12	11	25	125	09	≥16						
S1216P SCLCR/L 06	● ●	16	11.5	14.8	37	170	09	≥16						
S16P SCLCR/L 06	● ●	16	16	14.8	35	170	11	≥20	CC.T 0602..	4008-M2.5x6	-	-	80-T08	
S12K SCLCR/L 09	● ●	12	12	11	30	125	09	≥16						
S1416P SCLCR/L 09	● ●	16	14	14.8	45	170	9.5	≥17						
S16P SCLCR/L 09	● ●	16	16	14.8	35	170	11	≥20						
S1620R SCLCR/L 09	● ●	20	16	18.3	50	200	11	≥20						
S20R SCLCR/L 09	● ●	20	20	18.3	40	200	13	≥25						
S25S SCLCR/L 09	● ●	25	25	23	50	250	17	≥32	CC.T 09T3..	4015-M3.5x12	AACN-2-0001	AAV-08-M3.5x8	80-T15	
S32T SCLCR/L 09	● ●	32	32	30	60	300	22	≥40						
S25S SCLCR/L 12	● ●	25	25	23	50	250	17	≥32						
S32T SCLCR/L 12	● ●	32	32	30	60	300	22	≥40						
S40U SCLCR/L 12	● ●	40	40	37.5	70	350	27	≥50						
A08H SCLCR/L 06	● ●	08	8	7.3	20	100	06	≥11						CC.T 1204..
A10H SCLCR/L 06	● ●	10	10	09	25	100	07	≥13						
A12H SCLCR/L 06	● ●	12	12	11	25	100	09	≥16						
A16M SCLCR/L 09	● ●	16	16	14.8	35	150	11	≥20						
A20P SCLCR/L 09	● ●	20	20	18.3	40	170	13	≥25						
A25R SCLCR/L 09	● ●	25	25	23	50	200	17	≥32						
A32S SCLCR/L 09	● ●	32	32	30	60	250	22	≥40	CC.T 09T3..	4015-M3.5x12	AACN-2-0001	AAV-08-M3.5x8	80-T15	
A25R SCLCR/L 12	● ●	25	25	23	50	200	17	≥32						
									CC.T 1204..	4020-M4.5x12	AACN-2-0003	AAV-10-M4.5x8	80-T20	

R: Sağ / Right / Правый L: Sol / Left / Левый  
● Stokta / In Stock / В наличии ○ Stokta Yok / Non Stock Item / Нет в наличии

Sipariş Örneği/Ordering Example/Образец заказа  
1 ad./pcs./шт. S0608H SCLCR 03

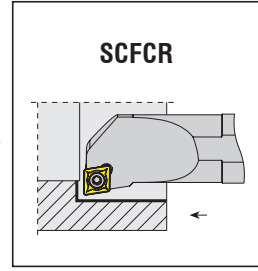
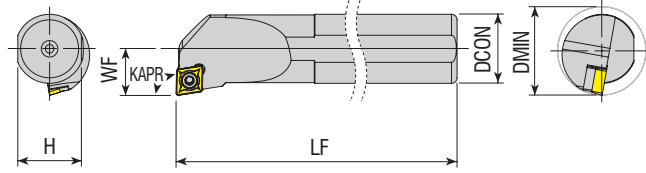

Takım Kodu Ordering Code Код для заказа	Stok Stock Наличие		Takım Ölçüleri (mm) Dimension (mm) Размеры (мм)				Kesici Uç Insert Пластина	Yedek Parçaları / Spare Parts / Запасные части				
	R	L	DCON	H	LF	WF		DMIN	Sıkma Vidası Screw Зажимной винт	Altık Shim Опорная пластина	Altık Vidası Shim Screw Винт опорной пластины	Tork Anahtar Torx Key Торх Ключ
S08H SCFCR/L 06	●	●	08	7.3	100	06	≥11	CC.T 0602..	4008-M2.5x6	-	-	80-T08
S10K SCFCR/L 06	●	●	10	09	125	07	≥13		4015-M3.5x8	-	-	
S12K SCFCR/L 06	●	●	12	11	125	09	≥16		4015-M3.5x9	-	-	
S12K SCFCR/L 09	●	●	12	11	125	09	≥16	CC.T 09T3..	4015-M3.5x12	AACN-2-0001	AAV-08-M3.5x8	80-T15
S16P SCFCR/L 09	●	●	16	14.8	170	11	≥20		4015-M3.5x12	-	-	
S20R SCFCR/L 09	●	●	20	18.3	200	13	≥25		4015-M3.5x12	AACN-2-0001	AAV-08-M3.5x8	
S25S SCFCR/L 09	●	●	25	23	250	17	≥32	CC.T 1204..	4020-M4.5x12	AACN-2-0003	AAV-10-M4.5x8	80-T20
S25S SCFCR/L 12	●	○	25	23	250	17	≥32		4020-M4.5x12	AACN-2-0003	AAV-10-M4.5x8	
S32T SCFCR/L 12	○	○	32	30	300	22	≥40		1020-M4.5x16	-	AAV-07-M4.5x13	
S40U SCFCR/L 12	○	○	40	37.5	350	27	≥50	CC.T 0602..	4008-M2.5x6	-	-	80-T08
A08H SCFCR/L 06	●	○	08	7.3	100	06	≥11		4008-M2.5x6	-	-	

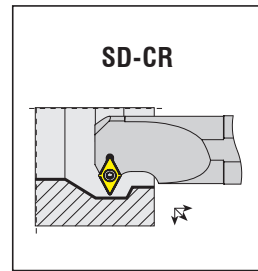
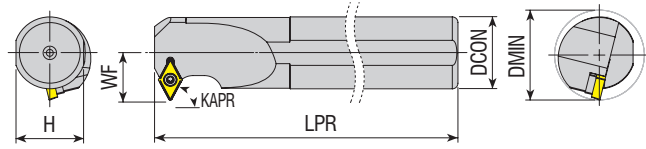

Takım Kodu Ordering Code Код для заказа	Stok Stock Наличие		Takım Ölçüleri (mm) Dimension (mm) Размеры (мм)				Kesici Uç Insert Пластина	Yedek Parçaları / Spare Parts / Запасные части				
	R	L	DCON	H	LPR	WF		DMIN	Sıkma Vidası Screw Зажимной винт	Altık Shim Опорная пластина	Altık Vidası Shim Screw Винт опорной пластины	Tork Anahtar Torx Key Торх Ключ
S10K SD-CR/L 07	●	●	10	9	125	07	≥14	DC.T 0702..	4008-M2.5x6	-	-	80-T08
S12K SD-CR/L 07	●	●	12	11	125	09	≥16		4015-M3.5x11	-	-	
S16P SD-CR/L 07	●	●	16	14.8	170	11	≥20		4015-M3.5x11	-	-	
S20R SD-CR/L 07	●	○	20	18.3	200	13	≥25	DC.T 11T3..	4015-M3.5x14	AADN-2-0001	AAV-06-M3.5x11	80-T15
S16P SD-CR/L 11	●	●	16	14.8	170	14	≥22		4015-M3.5x14	AADN-2-0001	AAV-06-M3.5x11	
S20R SD-CR/L 11	●	●	20	18.3	200	15	≥25		4015-M3.5x14	AADN-2-0001	AAV-06-M3.5x11	
S25S SD-CR/L 11	●	●	25	23	250	18	≥32		4015-M3.5x14	AADN-2-0001	AAV-06-M3.5x11	
S32T SD-CR/L 11	●	●	32	30	300	22	≥40	DC.T 11T3..	4015-M3.5x14	AADN-2-0001	AAV-06-M3.5x11	80-T15
S40U SD-CR/L 11	●	●	40	37.5	350	27	≥50		4015-M3.5x14	AADN-2-0001	AAV-06-M3.5x11	

R: Sağ / Right / Правый L: Sol / Left / Левый  
● Stokta / In Stock / В наличии ○ Stokta Yok / Non Stock Item / Нет в наличии

Sipariş Örneği/Ordering Example/Образец заказа  
1 ad./pcs./шт. S08H SCFCR 06



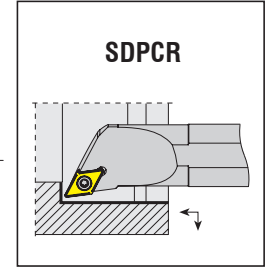
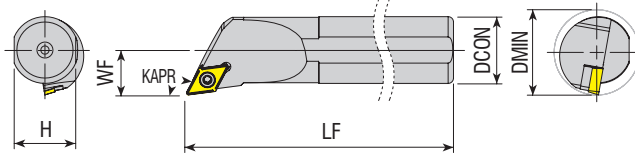

Takım Kodu Ordering Code Код для заказа	Stok Stock Наличие		Takım Ölçüleri (mm) Dimension (mm) Размеры (мм)				Kesici Uç Insert Пластина	Yedek Parçaları / Spare Parts / Запасные части				
	R	L	DCON	H	LF	WF		DMIN	Sıkma Vidası Screw Зажимной винт	Altlık Shim Опорная пластина	Altlık Vidası Shim Screw Винт опорной пластины	Tork Anahtar Torx Key Торх Ключ
S10K SDPCR/L 07	●	●	10	09	125	07	≥13	DC.T 0702..	4008-M2.5x6	-	-	80-T08
S12K SDPCR/L 07	●	●	12	11	125	09	≥16		4015-M3.5x9	-	-	
S16P SDPCR/L 11	●	●	16	14.8	170	11	≥20	DC.T 11T3..	4015-M3.5x11	-	-	80-T15
S20R SDPCR/L 11	●	●	20	18.3	200	13	≥25		4015-M3.5x12	AADN-2-0001	AAV-08-M3.5x8	
S25S SDPCR/L 11	●	●	25	23	250	17	≥32					

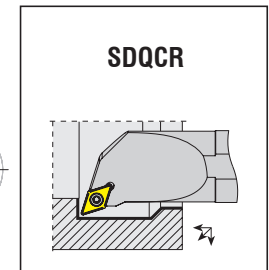
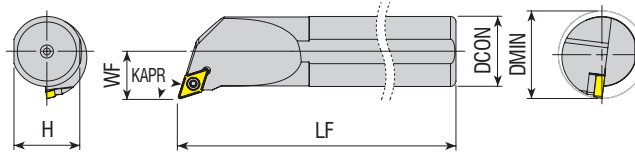

Takım Kodu Ordering Code Код для заказа	Stok Stock Наличие		Takım Ölçüleri (mm) Dimension (mm) Размеры (мм)				Kesici Uç Insert Пластина	Yedek Parçaları / Spare Parts / Запасные части				
	R	L	DCON	H	LF	WF		DMIN	Sıkma Vidası Screw Зажимной винт	Altlık Shim Опорная пластина	Altlık Vidası Shim Screw Винт опорной пластины	Tork Anahtar Torx Key Торх Ключ
S10K SDQCR/L 07	●	●	10	09	125	07	≥13	DC.T 0702..	4008-M2.5x6	-	-	80-T08
S12K SDQCR/L 07	●	●	12	11	125	09	≥16		4015-M3.5x9	-	-	
S16P SDQCR/L 07	●	●	16	14.8	170	11	≥20	DC.T 11T3..	4015-M3.5x11	-	-	80-T15
S20R SDQCR/L 07	●	●	20	18.3	200	13	≥25		4015-M3.5x12	AADN-2-0001	AAV-08-M3.5x8	
S16P SDQCR/L 11	●	●	16	14.8	170	11	≥20		4015-M3.5x14	AADN-2-0001	AAV-06-M3.5x11	
S20R SDQCR/L 11	●	●	20	18.3	200	13	≥25	DC.T 0702..	4008-M2.5x6	-	-	80-T08
S25S SDQCR/L 11	●	●	25	23	250	17	≥32		4015-M3.5x9	-	-	
S32T SDQCR/L 11	●	●	32	30	300	22	≥40	DC.T 11T3..	4015-M3.5x11	-	-	80-T15
S40U SDQCR/L 11	●	●	40	37.5	350	27	≥50		4015-M3.5x12	AADN-2-0001	AAV-08-M3.5x8	
A10H SDQCR/L 07	●	●	10	09	100	07	≥13		4015-M3.5x14	AADN-2-0001	AAV-06-M3.5x11	
A12H SDQCR/L 07	●	●	12	11	100	09	≥16	DC.T 0702..	4008-M2.5x6	-	-	80-T08
A16M SDQCR/L 07	●	●	16	14.8	150	11	≥20		4015-M3.5x9	-	-	
A20P SDQCR/L 07	●	●	20	18.3	170	13	≥25	DC.T 11T3..	4015-M3.5x11	-	-	80-T15
A16M SDQCR/L 11	●	●	16	14.8	150	11	≥20		4015-M3.5x12	AADN-2-0001	AAV-08-M3.5x8	
A20P SDQCR/L 11	●	●	20	18.3	170	13	≥25		4015-M3.5x14	AADN-2-0001	AAV-06-M3.5x11	
A25R SDQCR/L 11	●	●	25	23	200	17	≥32	DC.T 0702..	4008-M2.5x6	-	-	80-T08
A32S SDQCR/L 11	●	●	32	30	250	22	≥40		4015-M3.5x9	-	-	

R: Sağ / Right / Правый L: Sol / Left / Левый  
● Stokta / In Stock / В наличии ○ Stokta Yok / Non Stock Item / Нет в наличии

Sipariş Örneği/Ordering Example/Образец заказа  
1 ad./pcs./шт. S10K SDPCR 07

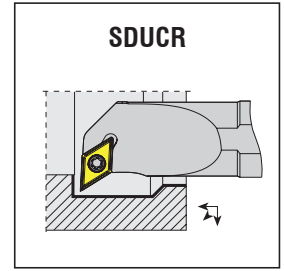
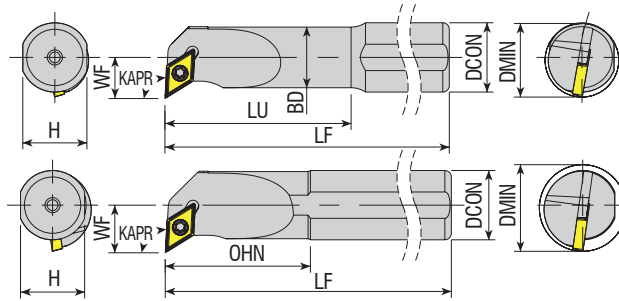

Takım Kodu Ordering Code Код для заказа	Stok Stock Наличие		Takım Ölçüleri (mm) Dimension (mm) Размеры (мм)							Kesici Uç Insert Пластина	Yedek Parçaları / Spare Parts / Запасные части			
	R	L	DCON	BD	H	LU=OHN	LF	WF	DMIN		Sıkma Vidası Screw Зажимной винт	Altık Shim Опорная пластина	Altık Vidası Shim Screw Винт опорной пластины	Tork Anahtar Torx Key Торк Ключ
S0810K SDUCR/L 07	●	●	10	8	09	30	125	08	≥13	DC.T 0702..	4008-M2.5x6	-	-	80-T08
S10K SDUCR/L 07	●	●	10	10	09	25	125	08	≥13					
S12K SDUCR/L 07	●	●	12	12	11	25	125	09	≥16					
S1216P SDUCR/L 07	●	●	16	11.5	14.8	37	170	09	≥16					
S1416P SDUCR/L 07	●	●	16	14	14.8	45	170	9.5	≥17					
S16P SDUCR/L 07	●	●	16	16	14.8	35	170	11	≥20					
S20R SDUCR/L 07	●	●	20	20	18.3	40	200	13	≥25					
S1416P SDUCR/L 11	●	●	16	14	14.8	45	170	11	≥18	DC.T 11T3..	4015-M3.5x9	-	-	80-T15
S16P SDUCR/L 11	●	●	16	16	14.8	35	170	11	≥20					
S1620R SDUCR/L 11	●	●	20	16	18.3	50	200	11	≥20					
S20R SDUCR/L 11	●	●	20	20	18.3	40	200	13	≥25					
S25S SDUCR/L 11	●	●	25	25	23	50	250	17	≥32					
S32T SDUCR/L 11	●	●	32	32	30	60	300	22	≥40					
S40U SDUCR/L 11	●	●	40	40	37.5	70	350	27	≥50					
S50V SDUCR/L 11	●	●	50	50	47	80	400	35	≥63					
A0810H SDUCR/L 07	●	●	10	8	09	30	100	08	≥13	DC.T 0702..	4008-M2.5x6	-	-	80-T08
A10H SDUCR/L 07	●	●	10	10	09	25	100	08	≥13					
A12H SDUCR/L 07	●	●	12	12	11	25	100	09	≥16					
A16M SDUCR/L 07	●	●	16	16	14.8	35	150	11	≥20					
A20P SDUCR/L 07	●	●	20	20	18.3	40	170	13	≥25	DC.T 11T3..	4015-M3.5x9	-	-	80-T15
A16M SDUCR/L 11	●	●	16	16	14.8	35	150	11	≥20					
A20P SDUCR/L 11	●	●	20	20	18.3	40	170	13	≥25					
A25R SDUCR/L 11	●	●	25	25	23	50	200	17	≥32					
A32S SDUCR/L 11	●	●	32	32	30	60	250	22	≥40					

R: Sağ / Right / Правый L: Sol / Left / Левый  
● Stokta / In Stock / В наличии ○ Stokta Yok / Non Stock Item / Нет в наличии

Sipariş Örneği/Ordering Example/Образец заказа  
1 ad./pcs./шт. S0810K SDUCR 07

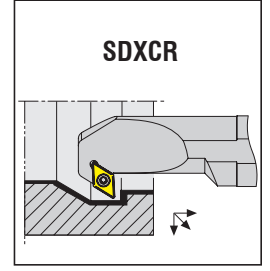
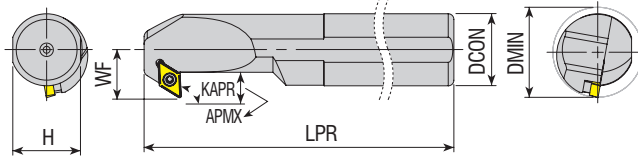

**Takım Kodu**  
**Ordering Code**  
Код для заказа

Stok  
Stock  
Наличие

Takım Ölçüleri (mm)  
Dimension (mm)  
Размеры (мм)

Kesici Uç  
Insert  
Пластина

Yedek Parçaları / Spare Parts / Запасные части

Sıkma Vidası  
Screw  
Зажимной винт

Altlık  
Shim  
Опорная пластина

Altlık Vidası  
Shim Screw  
Винт опорной пластины

Tork Anahtar  
Torx Key  
Торх Ключ

R L DCON H LPR WF APMX DMIN

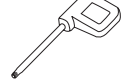
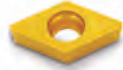

<b>S12K SDXCR/L 07</b>	●●	12	11	125	09	4.5	≥16	<b>DC.T 0702..</b>	4008-M2.5x6	-	-	80-T08
<b>S16P SDXCR/L 07</b>	●●	16	14.8	170	11	6.5	≥20					
<b>S20R SDXCR/L 07</b>	●●	20	18.3	200	13	6.5	≥25					
<b>S16P SDXCR/L 11</b>	●●	16	14.8	170	11	6.5	≥20	<b>DC.T 11T3..</b>	4015-M3.5x11	-	-	80-T15
<b>S20R SDXCR/L 11</b>	●●	20	18.3	200	14	7.5	≥25					
<b>S25S SDXCR/L 11</b>	●●	25	23	250	17	9	≥32					
<b>S32T SDXCR/L 11</b>	●●	32	30	300	22	12.5	≥40	4015-M3.5x14	AADN-2-0001	AAV-06-M3.5x11	80-T15	
<b>S40U SDXCR/L 11</b>	●●	40	37.5	350	27	14.5	≥50					
<b>A12H SDXCR/L 07</b>	●●	12	11	100	09	4.5	≥16					
<b>A16M SDXCR/L 07</b>	●●	16	14.8	150	11	6.5	≥20	<b>DC.T 0702..</b>	4008-M2.5x6	-	-	80-T08
<b>A20P SDXCR/L 07</b>	●●	20	18.3	170	13	6.5	≥25					
<b>A16M SDXCR/L 11</b>	●●	16	14.8	150	11	7.5	≥20					
<b>A20P SDXCR/L 11</b>	●●	20	18.3	170	14	7.5	≥25	<b>DC.T 11T3..</b>	4015-M3.5x11	-	-	80-T15
<b>A25R SDXCR/L 11</b>	●●	25	23	200	17	9	≥32					
<b>A32S SDXCR/L 11</b>	●●	32	30	250	22	12.5	≥40					

R: Sağ / Right / Правый L: Sol / Left / Левый  
● Stokta / In Stock / В наличии ○ Stokta Yok / Non Stock Item / Нет в наличии  
Not: "APMX" ölçüleri R0.4'e göre verilmiştir.  
Note: Dimensions of "APMX" are given according to R.0,4  
Примечание: размеры должны быть R.04

Sipariş Örneği/Ordering Example/Образец заказа  
1 ad./pcs./шт. S12K SDXCR 07

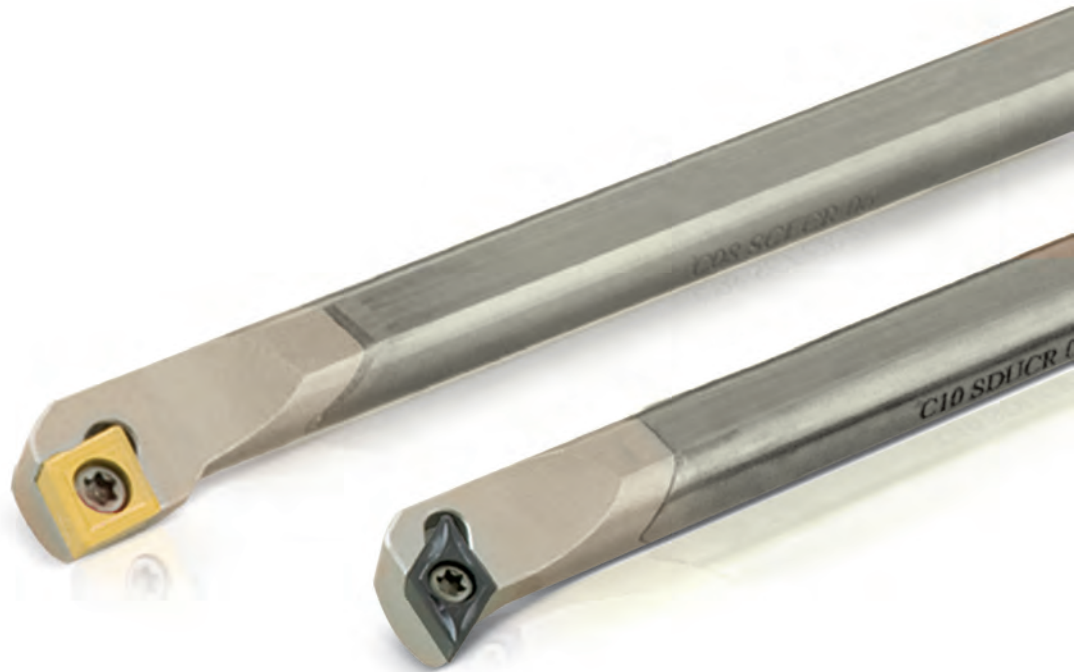

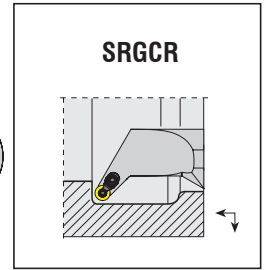
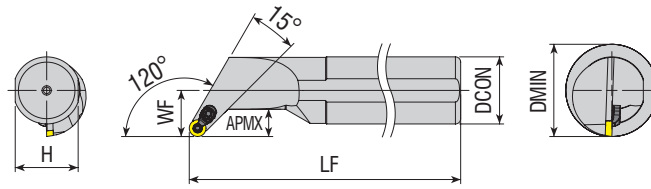

**Takım Kodu**  
**Ordering Code**  
Код для заказа

Stok Stock Наличие	Takım Ölçüleri (mm) Dimension (mm) Размеры (мм)							Kesici Uç Insert Пластина	Yedek Parçaları / Spare Parts / Запасные части						
	R	L	DCON	H	LF	WF	APMX		DMIN	Sıkma Vidası Screw Зажимной винт	Altık Shim Опорная пластина	Altık Vidası Shim Screw Винт опорной пластины	Baskı Pabuçu Shim Screw Spannpratze	Pabuç Vidası Shim Screw Зажимной винт	Anahtar Allen Key Ключ
S16P SRGCR/L 08	●	○	16	14.8	170	11	7	≥22	RCM. 0803..	3008-M3x8	-	-	-	-	80-T08
S20R SRGCR/L 08	●	●	20	18.3	200	13	7	≥26							
S25S SRGCR/L 08C	●	●	25	23	250	17	9.5	≥34							
S32T SRGCR/L 08C	●	○	32	30	300	22	13	≥44							
S40U SRGCR/L 08C	●	○	40	37.5	350	27	15	≥54							
A16M SRGCR/L 08	●	●	16	14.8	150	11	7	≥22							
A20P SRGCR/L 08	●	●	20	18.3	170	13	7	≥26							
A25R SRGCR/L 08C	●	●	25	23	200	17	9.5	≥34							
A32S SRGCR/L 08C	●	●	32	30	250	22	13	≥44							
A40T SRGCR/L 08C	●	●	40	37.5	300	27	15	≥54							



KAPR=45°

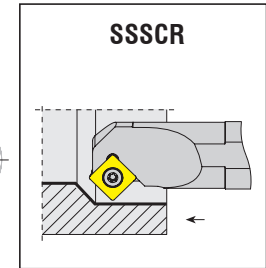
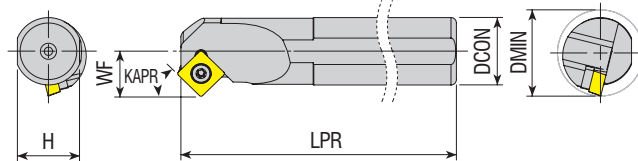

**Takım Kodu**  
**Ordering Code**  
Код для заказа

Stok Stock Наличие	Takım Ölçüleri (mm) Dimension (mm) Размеры (мм)							Kesici Uç Insert Пластина	Yedek Parçaları / Spare Parts / Запасные части			
	R	L	DCON	H	LPR	WF	DMIN		Sıkma Vidası Screw Зажимной винт	Altık Shim Опорная пластина	Altık Vidası Shim Screw Винт опорной пластины	Tork Anahtar Torx Key Торх Ключ
S16P SSSCR/L 09	●	●	16	14.8	170	11	≥20	SC.T 09T3..	4015-M3.5x9	-	-	80-T15
S20R SSSCR/L 09	●	●	20	18.3	200	13	≥25					
S25S SSSCR/L 09	●	●	25	23	250	17	≥32					
S25S SSSCR/L 12	●	●	25	23	250	17	≥32	SC.T 1204..	4020-M4.5x12	AASN-2-0004	AAV-10-M4.5x8	80-T20
S32T SSSCR/L 12	●	○	32	30	300	22	≥40					
S40U SSSCR/L 12	●	○	40	37.5	350	27	≥50					

R: Sağ / Right / Правый L: Sol / Left / Левый  
● Stokta / In Stock / В наличии ○ Stokta Yok / Non Stock Item / Нет в наличии

Sipariş Örneği/Ordering Example/Образец заказа  
1 ad./pcs./шт. S16P SRGCR 08



KAPR=60°

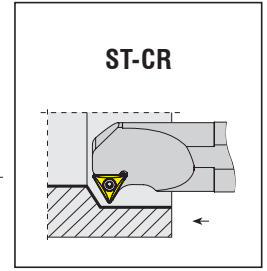
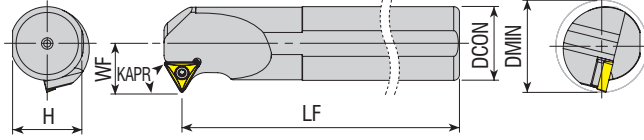

ST-CR

Takım Kodu Ordering Code Код для заказа	Stok Stock Наличие		Takım Ölçüleri (mm) Dimension (mm) Размеры (мм)				Kesici Uç Insert Пластина	Yedek Parçaları / Spare Parts / Запасные части				
	R	L	DCON	H	LF	WF		DMIN	Sıkma Vidası Screw Зажимной винт	Altlık Shim Опорная пластина	Altlık Vidası Shim Screw Винт опорной пластины	Tork Anahtar Torx Key Торх Ключ
	●	○										
S12K ST-CR/L 11	●	●	12	11	125	09	≥17	TC.T 1102..	4008-M2.5x6	-	-	80-T08
S16P ST-CR/L 11	●	○	16	14.8	170	11	≥20					
S20R ST-CR/L 11	●	○	20	18.3	200	13	≥25					
S16P ST-CR/L 16	●	●	16	14.8	170	11	≥20	TC.T 16T3..	4015-M3.5x9 4015-M3.5x11	-	-	80-T15
S20R ST-CR/L 16	●	●	20	18.3	200	13	≥25					
S25S ST-CR/L 16	●	●	25	23	250	17	≥32					
S32T ST-CR/L 16	●	●	32	30	300	22	≥40	4015-M3.5x14	AATN-2-0001	AAV-08-M3.5x8 AAV-06-M3.5x11	80-T15	
S40U ST-CR/L 16	●	●	40	37.5	350	27	≥50					



KAPR=90°

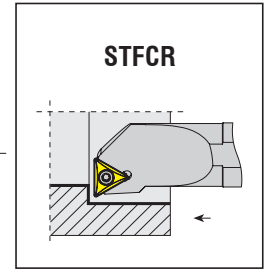
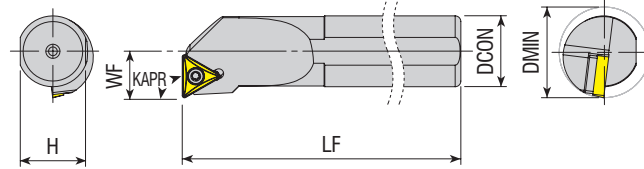

STFCR

Takım Kodu Ordering Code Код для заказа	Stok Stock Наличие		Takım Ölçüleri (mm) Dimension (mm) Размеры (мм)				Kesici Uç Insert Пластина	Yedek Parçaları / Spare Parts / Запасные части				
	R	L	DCON	H	LF	WF		DMIN	Sıkma Vidası Screw Зажимной винт	Altlık Shim Опорная пластина	Altlık Vidası Shim Screw Винт опорной пластины	Tork Anahtar Torx Key Торх Ключ
	●	○										
S0610F STFCR/L 06	●	●	10	09	80	4.5	≥08	TC.T 06T1..	3006-M2x4	-	-	80-T06
S08H STFCR/L 06	●	●	08	7.3	100	06	≥11					
S10K STFCR/L 09	●	●	10	09	125	07	≥13	TC.T 0902..	3007-M2.2x5	-	-	80-T07
S12K STFCR/L 09	●	●	12	11	125	09	≥17					
S12K STFCR/L 11	●	●	12	11	125	09	≥17	TC.T 1102..	4008-M2.5x6	-	-	80-T08
S16P STFCR/L 11	●	●	16	14.8	170	11	≥20					
S20R STFCR/L 11	●	●	20	18.3	200	13	≥25					
S16P STFCR/L 16	●	●	16	14.8	170	11	≥20	TC.T 16T3..	4015-M3.5x9 4015-M3.5x11	-	-	80-T15
S20R STFCR/L 16	●	●	20	18.3	200	13	≥25					
S25S STFCR/L 16	●	●	25	23	250	17	≥32					
S32T STFCR/L 16	●	●	32	30	300	22	≥40	4015-M3.5x14	AATN-2-0001	AAV-08-M3.5x8 AAV-06-M3.5x11	80-T15	
S40U STFCR/L 16	●	○	40	37.5	350	27	≥50					
A10H STFCR/L 11	●	●	10	09	100	07	≥13	TC.T 1102..	4008-M2.5x6	-	-	80-T08
A12H STFCR/L 11	●	●	12	11	100	09	≥17					
A16M STFCR/L 11	●	●	16	14.8	150	11	≥20					

R: Sağ / Right / Правый L: Sol / Left / Левый  
● Stokta / In Stock / В наличии ○ Stokta Yok / Non Stock Item / Нет в наличии

Sipariş Örneği/Ordering Example/Образец заказа  
1 ad./pcs./шт. S12K ST-CR 11

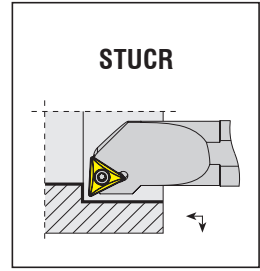
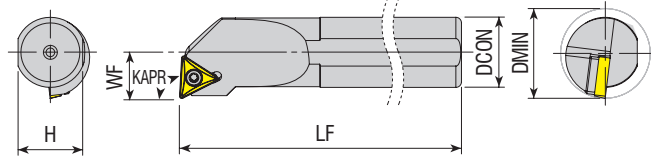

**Takım Kodu**  
**Ordering Code**  
Код для заказа

Stok Stock Наличие	Takım Ölçüleri (mm) Dimension (mm) Размеры (мм)						Kesici Uç Insert Пластина	Yedek Parçaları / Spare Parts / Запасные части				
	R	L	DCON	H	LF	WF		DMIN	Sıkma Vidası Screw Зажимной винт	Altılık Shim Опорная пластина	Altılık Vidası Shim Screw Винт опорной пластины	Tork Anahtar Torx Key Торх Ключ
● ●			10	09	125	07	≥13	TC.T 0902..	3007-M2.2x5			80-T07
● ●			12	11	125	09	≥16					
● ●			12	11	125	09	≥17	TC.T 1102..	4008-M2.5x6	-	-	80-T08
● ●			16	14.8	170	11	≥20					
● ●			20	18.3	200	13	≥25	TC.T 16T3..	4015-M3.5x9 4015-M3.5x11	-	-	80-T15
● ●			16	14.8	170	11	≥20					
● ●			20	18.3	200	13	≥25	TC.T 16T3..	4015-M3.5x14	AATN-2-0001	AAV-08-M3.5x8 AAV-06-M3.5x11	80-T15
● ●			25	23	250	17	≥32					
● ●			32	30	300	22	≥40	TC.T 0902..	3007-M2.2x5			80-T07
● ●			40	37.5	350	27	≥50					
● ●			10	09	100	07	≥13	TC.T 1102..	4008-M2.5x6	-	-	80-T08
● ●			12	11	100	09	≥16					
● ●			16	14.8	150	11	≥20	TC.T 16T3..	4015-M3.5x9 4015-M3.5x11	-	-	80-T15
● ●			20	18.3	170	13	≥25					
● ●			16	14.8	150	11	≥20	TC.T 16T3..	4015-M3.5x14	AATN-2-0001	AAV-08-M3.5x8 AAV-06-M3.5x11	80-T15
● ●			20	18.3	170	13	≥25					
● ●			25	23	200	17	≥32					
● ●			32	30	250	22	≥40					

R: Sağ / Right / Правый L: Sol / Left / Левый

● Stokta / In Stock / В наличии ○ Stokta Yok / Non Stock Item / Нет в наличии

Sipariş Örneği/Ordering Example/Образец заказа

1 ad./pcs./шт. S10K STUCR 09



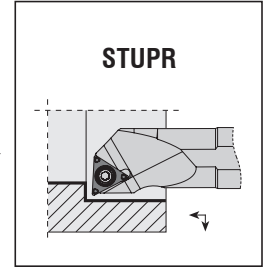
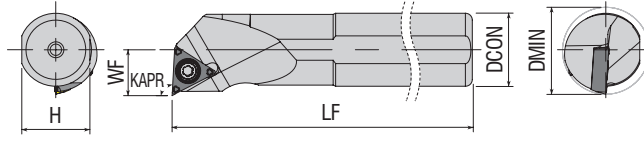

Takım Kodu Ordering Code Код для заказа	Stok Stock Наличие		Takım Ölçüleri (mm) Dimension (mm) Размеры (мм)				Kesici Uç Insert Пластина	Yedek Parçaları / Spare Parts / Запасные части				
	R	L	DCON	H	LF	WF		DMIN	Sıkma Vidası Screw Зажимной винт	Altlık Shim Опорная пластина	Altlık Vidası Shim Screw Винт опорной пластины	Tork Anahtar Torx Key Торх Ключ
S08H STUPR/L 0802	●	○	08	7.3	100	05	≥10	TP. 0802..	3006-M2x4			80-T06
S10K STUPR/L 1103	●	○	10	09	125	06	≥12		TP. 1103..			
S12K STUPR/L 1103	●	●	12	11	125	09	≥16	4010-M3x8				
S12M STUPR/L 1103	●	●	12	11	150	08	≥16					
S16P STUPR/L 1103	●	●	16	14.8	170	10	≥20					
S16R STUPR/L 1103	●	●	16	14.8	200	10	≥20					
A20R STUPR/L 1103	●	○	20	18.3	200	13	≥25					

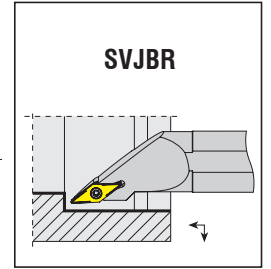
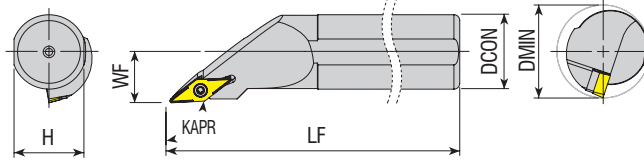

Takım Kodu Ordering Code Код для заказа	Stok Stock Наличие		Takım Ölçüleri (mm) Dimension (mm) Размеры (мм)				Kesici Uç Insert Пластина	Yedek Parçaları / Spare Parts / Запасные части				
	R	L	DCON	H	LF	WF		DMIN	Sıkma Vidası Screw Зажимной винт	Altlık Shim Опорная пластина	Altlık Vidası Shim Screw Винт опорной пластины	Tork Anahtar Torx Key Торх Ключ
S25S SVJBR/L 16	●	●	25	23	250	17	≥32	VB.T 1604..	4015-M3.5x12	AAVN-2-0002	AAV-08-M3.5x8	80-T15
S32T SVJBR/L 16	●	●	32	30	300	22	≥40		4015-M3.5x14		AAV-06-M3.5x11	
S40U SVJBR/L 16	●	●	40	37.5	350	27	≥50					

R: Sağ / Right / Правый L: Sol / Left / Левый  
● Stokta / In Stock / В наличии ○ Stokta Yok / Non Stock Item / Нет в наличии

Sipariş Örneği/Ordering Example/Образец заказа  
1 ad./pcs./шт. S08H STUPR 0802

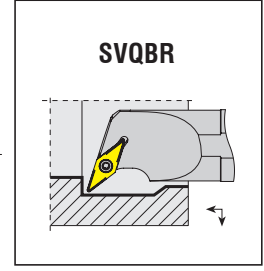
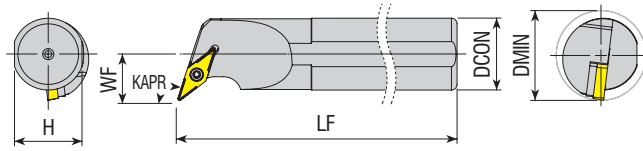

Takım Kodu Ordering Code Код для заказа	Stok Stock Наличие		Takım Ölçüleri (mm) Dimension (mm) Размеры (мм)				Kesici Uç Insert Пластина	Yedek Parçaları / Spare Parts / Запасные части				
	R	L	DCON	H	LF	WF		DMIN	Sıkma Vidası Screw Зажимной винт	Altık Shim Отпорная пластина	Altık Vidası Shim Screw Винт отпорной пластины	Tork Anahtar Torx Key Торх Ключ
	●	●										
S16P SVQBR/L 11	●	●	16	14.8	170	11	≥20	VB.T 1103..	4008-M2.5x6	-	-	80-T08
S20R SVQBR/L 11	●	●	20	18.3	200	13	≥25					
S25S SVQBR/L 16	●	●	25	23	250	17	≥32	VB.T 1604..	4015-M3.5x14	AAVN-2-0002	AAV-08-M3.5x8 AAV-06-M3.5x11	80-T15
S32T SVQBR/L 16	●	●	32	30	300	22	≥40					
S40U SVQBR/L 16	●	●	40	37.5	350	27	≥50	VB.T 1103..	4008-M2.5x6 4015-M3.5x11	-	-	80-T08
A20Q SVQBR/L 11	●	●	20	18.5	180	13	≥25					
A20Q SVQBR/L 16	●	●	20	18.5	180	20	≥30	VB.T 1604..	4015-M3.5x14	AAVN-2-0002	AAV-06-M3.5x11	80-T15
A25S SVQBR/L 16	●	●	25	23	250	17	≥32					
A32S SVQBR/L 16	●	●	32	30	250	22	≥40					

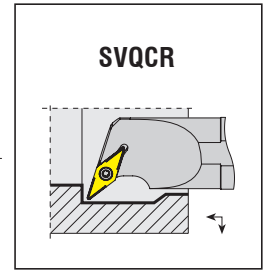
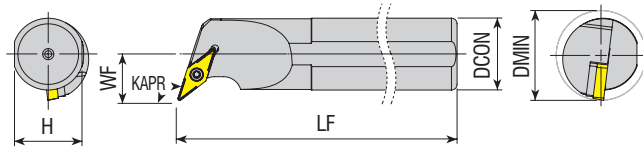

Takım Kodu Ordering Code Код для заказа	Stok Stock Наличие		Takım Ölçüleri (mm) Dimension (mm) Размеры (мм)				Kesici Uç Insert Пластина	Yedek Parçaları / Spare Parts / Запасные части				
	R	L	DCON	H	LF	WF		DMIN	Sıkma Vidası Screw Зажимной винт	Altık Shim Отпорная пластина	Altık Vidası Shim Screw Винт отпорной пластины	Tork Anahtar Torx Key Торх Ключ
	●	●										
S16P SVQCR/L 11	●	●	16	14.8	170	11	≥20	VC.T 1103..	4008-M2.5x6	-	-	80-T08
S20R SVQCR/L 11	●	●	20	18.3	200	13	≥25					
S25S SVQCR/L 16	●	●	25	23	250	17	≥32	VC.T 1604..	4015-M3.5x14	AAVN-2-0002	AAV-08-M3.5x8 AAV-06-M3.5x11	80-T15
S32T SVQCR/L 16	●	●	32	30	300	22	≥40					
S40U SVQCR/L 16	●	●	40	37.5	350	27	≥50	VC.T 1103..	4008-M2.5x6	-	-	80-T08
A16M SVQCR/L 11	●	●	16	14.8	150	11	≥20					
A20P SVQCR/L 11	●	●	20	18.3	170	13	≥25	VC.T 1604..	4015-M3.5x14	AAVN-2-0002	AAV-08-M3.5x8 AAV-06-M3.5x11	80-T15
A25R SVQCR/L 16	●	●	25	23	200	17	≥32					
A32S SVQCR/L 16	●	●	32	30	250	22	≥40					
A40T SVQCR/L 16	●	●	40	37.5	300	27	≥50					

R: Sağ / Right / Правый L: Sol / Left / Левый  
● Stokta / In Stock / В наличии ○ Stokta Yok / Non Stock Item / Нет в наличии

Sipariş Örneği/Ordering Example/Образец заказа  
1 ad./pcs./шт. S16P SVQBR 11



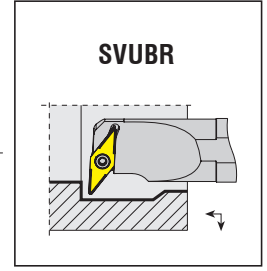
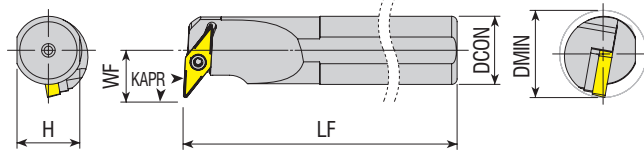

Takım Kodu Ordering Code Код для заказа	Stok Stock Наличие		Takım Ölçüleri (mm) Dimension (mm) Размеры (мм)					Kesici Uç Insert Пластина	Yedek Parçaları / Spare Parts / Запасные части			
	R	L	DCON	H	LF	WF	DMIN		Sıkma Vidası Screw Зажимной винт	Altık Shim Отверная пластина	Altık Vidası Shim Screw Винт отверной пластины	Tork Anahtar Torx Key Торх Ключ
S16P SVUBR/L 11	●	●	16	14.8	170	12.5	≥20	VB.T 1103..	4008-M2.5x6	-	-	80-T08
S20R SVUBR/L 11	●	●	20	18.3	200	13	≥25					
S25S SVUBR/L 16	●	●	25	23	250	19	≥32	VB.T 1604..	4015-M3.5x14	AAVN-2-0002	AAV-06-M3.5x11	80-T15
S32T SVUBR/L 16	●	●	32	30	300	22	≥40					
S40U SVUBR/L 16	●	●	40	37.5	350	27	≥50					
A20Q SVUBR/L 16	●	○	20	18.3	180	20	≥30					
A32S SVUBR/L 16	●	●	32	30	250	22	≥40	4015-M3.5x14	AAVN-2-0002	AAV-06-M3.5x11		

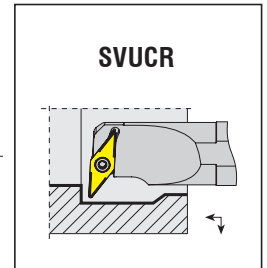
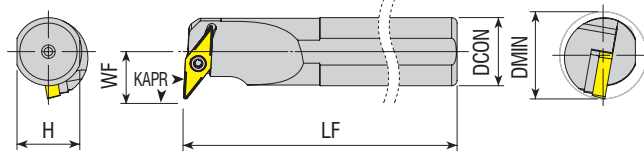

Takım Kodu Ordering Code Код для заказа	Stok Stock Наличие		Takım Ölçüleri (mm) Dimension (mm) Размеры (мм)					Kesici Uç Insert Пластина	Yedek Parçaları / Spare Parts / Запасные части			
	R	L	DCON	H	LF	WF	DMIN		Sıkma Vidası Screw Зажимной винт	Altık Shim Отверная пластина	Altık Vidası Shim Screw Винт отверной пластины	Tork Anahtar Torx Key Торх Ключ
S16P SVUCR/L 11	●	●	16	14.8	170	12.5	≥20	VC.T 1103..	4008-M2.5x6	-	-	80-T08
S20R SVUCR/L 11	●	●	20	18.3	200	13	≥25					
S25S SVUCR/L 16	●	●	25	23	250	19	≥32	VC.T 1604..	4015-M3.5x14	AAVN-2-0002	AAV-06-M3.5x11	80-T15
S32T SVUCR/L 16	●	●	32	30	300	22	≥40					
S40U SVUCR/L 16	●	●	40	37.5	350	27	≥50					
A12K SVUCR/L 07	●	●	12	11	125	9	≥16					
A20P SVUCR/L 11	●	○	20	18.3	170	13	≥25	VC.T 1103..	4008-M2.5x6	-	-	80-T08
A20Q SVUCR/L 11	●	●	20	18.3	180	13	≥25	VC.T 1103..	4008-M2.5x6	-	-	80-T08
A25R SVUCR/L 16	●	●	25	23	200	19	≥32	VC.T 1604..	4015-M3.5x14	AAVN-2-0002	AAV-06-M3.5x11	80-T15

R: Sağ / Right / Правый L: Sol / Left / Левый  
● Stokta / In Stock / В наличии ○ Stokta Yok / Non Stock Item / Нет в наличии

Sipariş Örneği/Ordering Example/Образец заказа  
1 ad./pcs./шт. S16P SVUBR 11

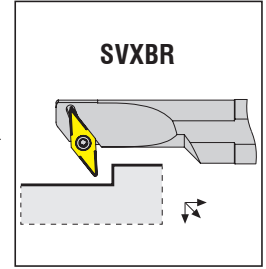
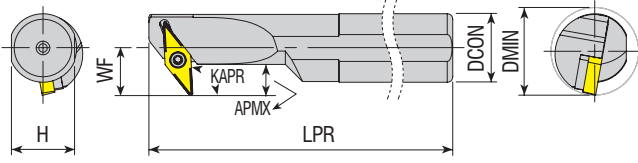

Takım Kodu Ordering Code Код для заказа	Stok Stock Наличие	Takım Ölçüleri (mm) Dimension (mm) Размеры (мм)						Kesici Uç Insert Пластина	Yedek Parçaları / Spare Parts / Запасные части			
		R	L	DCON	H	LPR	WF		APMX	DMIN	Sıkma Vidası Screw Зажимной винт	Altılık Shim Отпорная пластина
S16P SVXBR/L 1102	● ○	16	14.8	170	12.5	7.2	≥20	VBM. 1102..	4008-M2.5x6	-	-	80-T08
S20R SVXBR/L 1102	● ●	20	18.3	200	13	5.7	≥25					
S16P SVXBR/L 11	● ●	16	14.8	170	12.5	7.2	≥20	VB.T 1103..	4015-M3.5x14	AAVN-2-0002	AAV-06-M3.5x11	80-T15
S20R SVXBR/L 11	● ●	20	18.3	200	13	5.7	≥25					
S25S SVXBR/L 16	● ●	25	23	250	19	10.2	≥32	VB.T 1604..	4015-M3.5x14	AAVN-2-0002	AAV-06-M3.5x11	80-T15
S32T SVXBR/L 16	● ●	32	30	300	22	11.7	≥40					
S40U SVXBR/L 16	● ●	40	37.5	350	27	14.3	≥50					

Not: "APMX" ölçüleri R0.4'e göre verilmiştir.  
Note: Dimensions of "APMX" are given according to R.0.4  
Примечание: размеры должны быть R.04

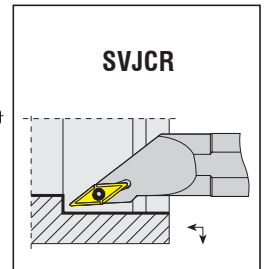
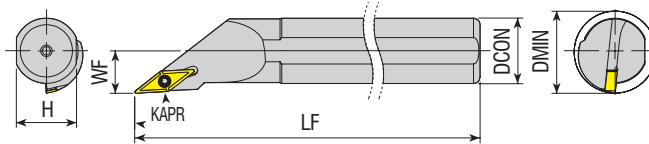

Takım Kodu Ordering Code Код для заказа	Stok Stock Наличие	Takım Ölçüleri (mm) Dimension (mm) Размеры (мм)						Kesici Uç Insert Пластина	Yedek Parçaları / Spare Parts / Запасные части			
		R	L	DCON	H	LF	WF		DMIN	Sıkma Vidası Screw Зажимной винт	Altılık Shim Отпорная пластина	Altılık Vidası Shim Screw Винт отпорной пластины
S12K SVJCR/L 11	● ●	12	11	125	7	≥13	VC.T 1103..	4008-M2.5x6	-	-	80-T08	
S16P SVJCR/L 11	● ●	16	14.8	170	11	≥20						
S20R SVJCR/L 11	● ●	20	18.3	200	13	≥25						
A12H SVJCR/L 11	● ●	12	11	100	07	≥13						
A16M SVJCR/L 11	● ●	16	14.8	150	11	≥20						
A20P SVJCR/L 11	● ●	20	18.3	170	13	≥25						

R: Sağ / Right / Правый L: Sol / Left / Левый  
● Stokta / In Stock / В наличии ○ Stokta Yok / Non Stock Item / Нет в наличии

Sipariş Örneği/Ordering Example/Образец заказа  
1 ad./pcs./шт. S16P SVXBR 1102

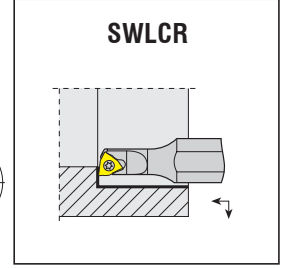
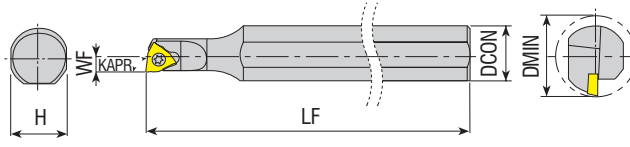

Takım Kodu Ordering Code Код для заказа	Stok Stock Наличие	Takım Ölçüleri (mm) Dimension (mm) Размеры (мм)					Kesici Uç Insert Пластина	Yedek Parçaları / Spare Parts / Запасные части			
		DCON	H	LF	WF	DMIN		Sıkma Vidası Screw Зажимной винт	Altlık Shim Опорная пластина	Altlık Vidası Shim Screw Винт опорной пластины	Tork Anahtar Torx Key Торх Ключ
S0608H SWLCR 03	●	08	7.3	100	04	≥08	WC.. 0302..	4008-M2.5x4	-	-	80-T08
S0810K SWLCR 03	●	10	09	125	06	≥10		4008-M2.5x4.5	-	-	

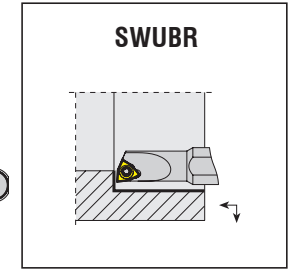
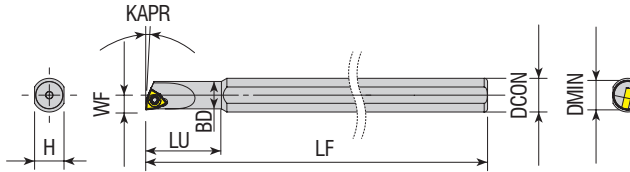

Takım Kodu Ordering Code Код для заказа	Stok Stock Наличие	Takım Ölçüleri (mm) Dimension (mm) Размеры (мм)							Kesici Uç Insert Пластина	Yedek Parçaları / Spare Parts / Запасные части			
		DCON	BD	H	LU	LF	DMIN	WF		Sıkma Vidası Screw Зажимной винт	Altlık Shim Опорная пластина	Altlık Vidası Shim Screw Винт опорной пластины	Tork Anahtar Torx Key Торх Ключ
S0610H SWUBR 06	●	10	5	7.3	18	100	≥6	3	WBGТ 060102-L	3006-M2x3.3	-	-	80-T06
S08H SWUBR 06-5.5	●	08	5	7.3	18	100	≥5.7	2.75		3006-M2x4	-	-	
S08H SWUBR 06-7	●	08	6.5	7.3	18	100	≥7	3.5		-	-	-	

R: Sağ / Right / Правый L: Sol / Left / Левый

● Stokta / In Stock / В наличии ○ Stokta Yok / Non Stock Item / Нет в наличии

KYCR-ISCR Ucuna Uygundur. / Compatible with KYCR-ISCR Insert. / Под пластину KYCR-ISCR

Sipariş Örneği/Ordering Example/Образец заказа

1 ad./pcs./шт. S0608H SWLCR 03

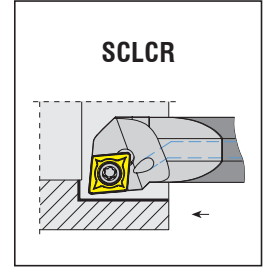
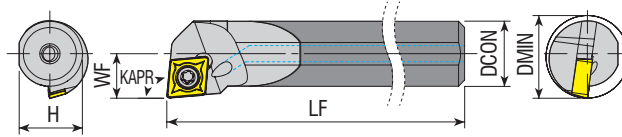

Takım Kodu Ordering Code Код для заказа	Stok Stock Наличие		Takım Ölçüleri (mm) Dimension (mm) Размеры (мм)					Kesici Uç Insert Пластина	Yedek Parçaları / Spare Parts / Запасные части			
	R	L	DCON	H	LF	WF	DMIN		Sıkma Vidası Screw Зажимной винт	Altlık Shim Отверная пластина	Altlık Vidası Shim Screw Винт отверной пластины	Tork Anahtar Torx Key Торх Ключ
<b>C06J SCLCR/L 06</b>	●	○	6	5.7	110	4.5	≥8	<b>CC.T 0602..</b>				
<b>E08K SCLCR/L 06</b>	●	●	8	7.5	125	6	≥11					
<b>E10M SCLCR/L 06</b>	●	●	10	9.5	150	7	≥13					
<b>E12Q SCLCR/L 06</b>	●	●	12	11	180	9	≥16					
<b>E16R SCLCR/L 09</b>	●	●	16	15	200	11	≥20	<b>CC.T 09T3..</b>				
<b>E20S SCLCR/L 09</b>	●	●	20	19	250	13	≥24					

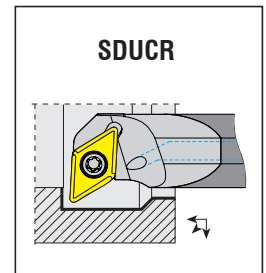
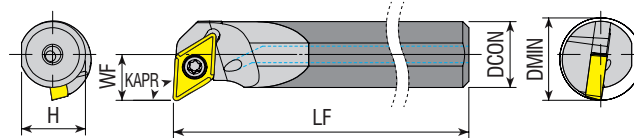

Takım Kodu Ordering Code Код для заказа	Stok Stock Наличие		Takım Ölçüleri (mm) Dimension (mm) Размеры (мм)					Kesici Uç Insert Пластина	Yedek Parçaları / Spare Parts / Запасные части			
	R	L	DCON	H	LF	WF	DMIN		Sıkma Vidası Screw Зажимной винт	Altlık Shim Отверная пластина	Altlık Vidası Shim Screw Винт отверной пластины	Tork Anahtar Torx Key Торх Ключ
<b>E10M SDUCR/L 07</b>	●	●	10	9.5	150	8	≥13	<b>DC.T 0702..</b>				
<b>E12Q SDUCR/L 07</b>	●	●	12	11	180	9	≥16					
<b>E16R SDUCR/L 11</b>	●	●	16	15	200	11	≥20	<b>DC.T 11T3..</b>				
<b>E20S SDUCR/L 11</b>	●	●	20	18.3	250	12	≥23					

R: Sağ / Right / Правый L: Sol / Left / Левый

● Stokta / In Stock / В наличии ○ Stokta Yok / Non Stock Item / Нет в наличии

Sipariş Örneği/Ordering Example/Образец заказа

1 ad./pcs./шт. C06J SCLCR 06



KAPR=90°

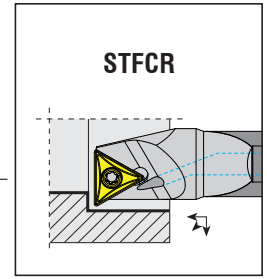
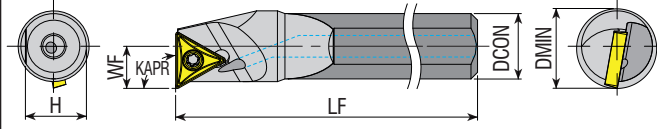

Takım Kodu Ordering Code Код для заказа	Stok Stock Наличие		Takım Ölçüleri (mm) Dimension (mm) Размеры (мм)				Kesici Uç Insert Пластина	Yedek Parçaları / Spare Parts / Запасные части				
	R	L	DCON	H	LF	WF		DMIN	Sıkma Vidası Screw Зажимной винт	Altık Shim Опорная пластина	Altık Vidası Shim Screw Винт опорной пластины	Tork Anahtar Torx Key Торх Ключ
E10M STFCR/L 09	●	○	10	9.5	150	6	12	TC.T 0902..	3007-M2.2x5	-	-	80-T07
E12Q STFCR/L 09	●	○	12	11	180	8	15					
E12Q STFCR/L 11	●	○	12	11	180	8	15					



KAPR=93°

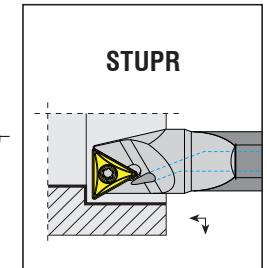
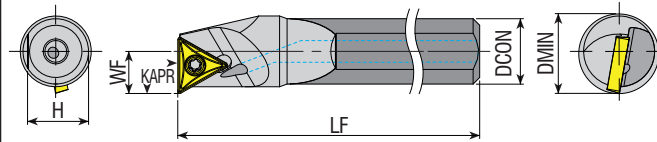

Takım Kodu Ordering Code Код для заказа	Stok Stock Наличие		Takım Ölçüleri (mm) Dimension (mm) Размеры (мм)				Kesici Uç Insert Пластина	Yedek Parçaları / Spare Parts / Запасные части				
	R	L	DCON	H	LF	WF		DMIN	Sıkma Vidası Screw Зажимной винт	Altık Shim Опорная пластина	Altık Vidası Shim Screw Винт опорной пластины	Tork Anahtar Torx Key Торх Ключ
E12Q STUPR/L 1103	●	○	12	11	180	8	15	TP. 1103..	4010-M3x6	-	-	80-T10
E16R STUPR/L 1103	●	○	16	15	200	11	20					

R: Sağ / Right / Правый L: Sol / Left / Левый  
● Stokta / In Stock / В наличии ○ Stokta Yok / Non Stock Item / Нет в наличии

Sipariş Örneği/Ordering Example/Образец заказа  
1 ad./pcs./шт. E10M STFCR 09

SCLCR

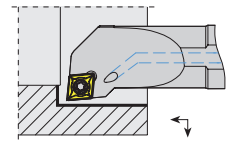

SET-A/SCLCR/L

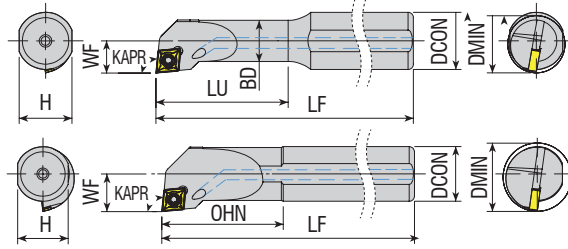

Takım Kodu  
Ordering Code  
Код для заказа

Stok  
Stock  
Наличие

Takım Ölçüleri (mm)  
Dimension (mm)  
Размеры (мм)

Kesici Uç  
Insert  
Пластина

Yedek Parçaları / Spare Parts / Запасные части

R	L	DCON	BD	H	LU=OHN	LF	WF	DMIN	Kesici Uç Insert Пластина	Sıkma Vidası Screw Зажимной винт	Altlık Shim Опорная пластина	Altlık Vidası Shim Screw Винт опорной пластины	Tork Anahtar Torx Key Торх Ключ
●	●	8	8	7.3	20	100	6	≥11	CC.T 0602..	4008-M2.5x6	-	-	80-T08
●	●	10	10	9	25	100	7	≥13					
●	●	12	12	11	25	100	9	≥16					
●	●	16	16	14.8	35	150	11	≥20					

SCLCR

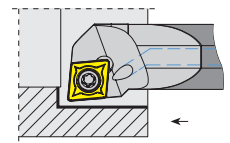

SET-E/SCLCR/L

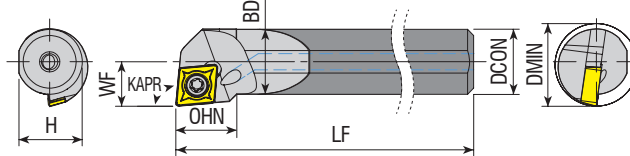

Takım Kodu  
Ordering Code  
Код для заказа

Stok  
Stock  
Наличие

Takım Ölçüleri (mm)  
Dimension (mm)  
Размеры (мм)

Kesici Uç  
Insert  
Пластина

Yedek Parçaları / Spare Parts / Запасные части

R	L	DCON	BD	H	OHN	LF	WF	DMIN	Kesici Uç Insert Пластина	Sıkma Vidası Screw Зажимной винт	Altlık Shim Опорная пластина	Altlık Vidası Shim Screw Винт опорной пластины	Tork Anahtar Torx Key Торх Ключ
●	○	8	8	7.5	10	125	6	≥11	CC.T 0602..	4008-M2.5x6	-	-	80-T08
●	○	10	10	9.5	10	150	7	≥13					
●	○	12	12	11	12	180	9	≥16					
●	○	16	16	15	15	200	11	≥20					

SCLCR

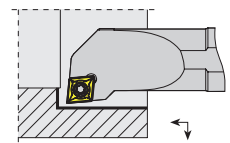

SET-S/SCLCR/L

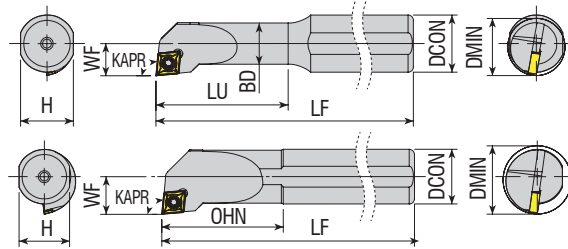

Takım Kodu  
Ordering Code  
Код для заказа

Stok  
Stock  
Наличие

Takım Ölçüleri (mm)  
Dimension (mm)  
Размеры (мм)

Kesici Uç  
Insert  
Пластина

Yedek Parçaları / Spare Parts / Запасные части

R	L	DCON	BD	H	LU=OHN	LF	WF	DMIN	Kesici Uç Insert Пластина	Sıkma Vidası Screw Зажимной винт	Altlık Shim Опорная пластина	Altlık Vidası Shim Screw Винт опорной пластины	Tork Anahtar Torx Key Торх Ключ
●	●	8	8	7.3	20	100	6	≥11	CC.T 0602..	4008-M2.5x6	-	-	80-T08
●	●	10	10	9	25	125	7	≥13					
●	●	12	12	11	25	125	9	≥16					
●	●	16	16	14.8	35	170	11	≥20					

R: Sağ / Right / Правый L: Sol / Left / Левый

● Stokta / In Stock / В наличии ○ Stokta Yok / Non Stock Item / Нет в наличии

Sipariş Örneği/Ordering Example/Образец заказа

1 ad./pcs./шт. A08H SCLCR 06

SET-A/SDUCR/L

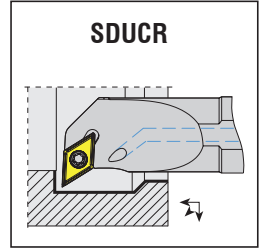
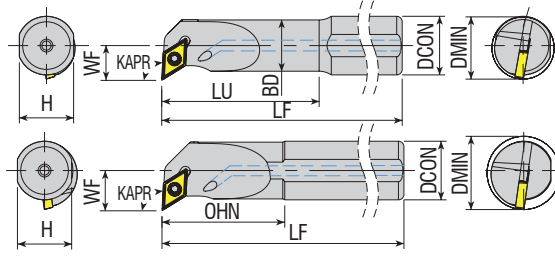

Takım Kodu  
Ordering Code  
Код для заказа

Stok Stock Наличие	Takım Ölçüleri (mm) Dimension (mm) Размеры (мм)								Kesici Uç Insert Пластина	Yedek Parçaları / Spare Parts / Запасные части									
	R	L	DCON	BD	H	LU=OHN	LF	WF		DMIN	Sıkma Vidası Screw Зажимной винт	Altlık Shim Опорная пластина	Altlık Vidası Shim Screw Винт опорной пластины	Tork Anahtar Torx Key Торх Ключ					
A10H SDUCR/L 07	●	●	10	10	09	25	100	08	≥13										
A12H SDUCR/L 07	●	●	12	12	11	25	100	09	≥16						DC.T 0702..	4008-M2.5x6	-	-	80-T08
A16M SDUCR/L 11	●	●	16	16	14.8	35	150	11	≥20						DC.T 11T3..	4015-M3.5x9	-	-	80-T15

SET-E/SDUCR/L

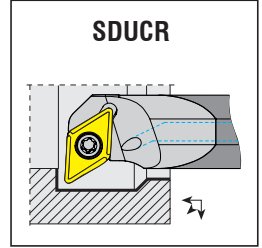
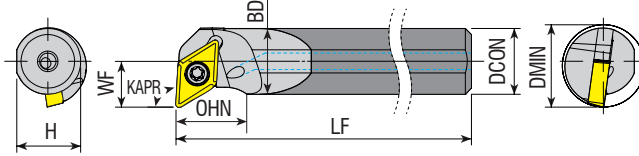

Takım Kodu  
Ordering Code  
Код для заказа

Stok Stock Наличие	Takım Ölçüleri (mm) Dimension (mm) Размеры (мм)								Kesici Uç Insert Пластина	Yedek Parçaları / Spare Parts / Запасные части									
	R	L	DCON	BD	H	OHN	LF	WF		DMIN	Sıkma Vidası Screw Зажимной винт	Altlık Shim Опорная пластина	Altlık Vidası Shim Screw Винт опорной пластины	Tork Anahtar Torx Key Торх Ключ					
E10M SDUCR/L 07	●	○	10	10	9.5	09	150	8	≥13										
E12Q SDUCR/L 07	●	○	12	12	11	10	180	9	≥16						DC.T 0702..	4008-M2.5x6	-	-	80-T08
E16R SDUCR/L 11	●	○	16	16	15	12	200	11	≥20						DC.T 11T3..	4015-M3.5x9	-	-	80-T15

SET-S/SDUCR/L

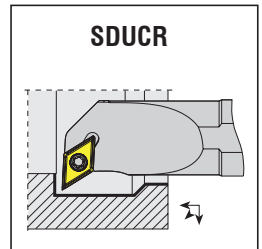
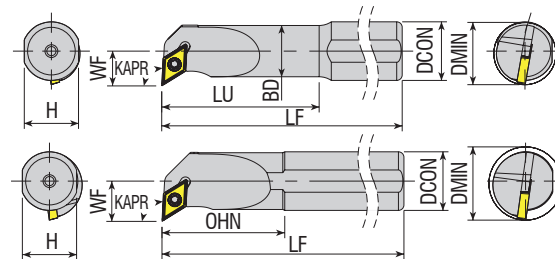

Takım Kodu  
Ordering Code  
Код для заказа

Stok Stock Наличие	Takım Ölçüleri (mm) Dimension (mm) Размеры (мм)								Kesici Uç Insert Пластина	Yedek Parçaları / Spare Parts / Запасные части									
	R	L	DCON	BD	H	LU=OHN	LF	WF		DMIN	Sıkma Vidası Screw Зажимной винт	Altlık Shim Опорная пластина	Altlık Vidası Shim Screw Винт опорной пластины	Tork Anahtar Torx Key Торх Ключ					
S10K SDUCR/L 07	●	●	10	10	9	25	125	8	≥13										
S12K SDUCR/L 07	●	●	12	12	11	25	125	9	≥16						DC.T 0702..	4008-M2.5x6	-	-	80-T08
S16P SDUCR/L 11	●	●	16	16	14.8	35	170	11	≥20						DC.T 11T3..	4015-M3.5x9	-	-	80-T15

R: Sağ / Right / Правый L: Sol / Left / Левый  
● Stokta / In Stock / В наличии ○ Stokta Yok / Non Stock Item / Нет в наличии

Sipariş Örneği/Ordering Example/Образец заказа  
1 ad./pcs./шт. SET-A/SDUCR



*konusulan*  
*the spoken kalite...*  
*quality...*

# TIRLAMAZ

TIRLAMAZ TAKIMLAR  
ANTIVIBRATION TOOLS  
АНТИВИБРАЦИОННЫЕ ДЕРЖАВКИ



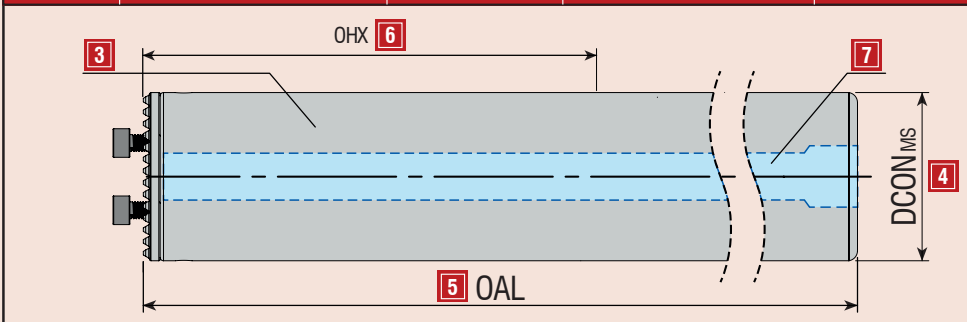

AKKO **A** **TT** **B** **D16** **204** **10D** **H** **E**

<b>2</b> Takım Tipi Tool Type Тип Инструмента	<b>3</b> Gövde Body Корпус	<b>4</b> Bağlantı Çapı Connection Diameter Диаметр Соединение	<b>5</b> Takım Boyu Overall length Общая Длина инструмента	<b>6</b> Bağlama Boyu Overhang maximum Максимум длина соединения	<b>7</b> İçten Soğutmalı With Coolant Hole С охлаждающим отверстием
Tırlamaz Takım Anti Vibration Tool Антивибрационная Державка					
<b>8</b> Takım Malzemesi Type of Boring Bar Тип расточной оправки					
Karbür Takviyeli Carbide reinforced Армированный карбид					

AKKO **A** **TT** **C** **A** **16** **SDUCR11**

<b>2</b> Takım Tipi Tool Type Тип Инструмента	<b>3</b> Kartuş Kodu Cartridge Code Код картриджа	<b>4</b> İçten Soğutmalı With Coolant Hole С охлаждающим отверстием	<b>5</b> Bağlama Çapı Connection Diameter Диаметр Соединение
Tırlamaz Takım Kartuşu Anti Vibration Tool Cartridge Картриджи для Антивибрационных инструментов	Kartuş Cartridge Картридж		Ø16 - Ø20 - Ø25 Ø32 - Ø40
<b>2</b> Kartuş Tipi Cartridge Type Тип Картриджа	SDUCR/L, SCLCR/L, SVUCR/L, TCLNR/L, TDUNR/L		
			

AKKO **A** **TT** **C** **16-25**

<b>2</b> Takım Tipi Tool Type Тип Инструмента	<b>3</b> Kartuş Cartridge Картридж	<b>4</b> Kullanılan Gövde Çap Aralığı Usable diameter range for body Используемый диапазон диаметров для корпуса
Tırlamaz Takım Kartuşu Anti Vibration Tool Cartridge Картриджи для Антивибрационных инструментов	Merkezeleme Kartuş Kodu Centering Cartridge Code Код для центрирующего картриджа	ATTB-D16/D20/D25 ATTB-D32/D40/D50/D60

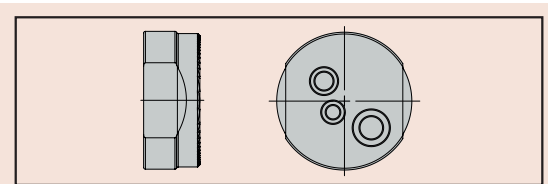

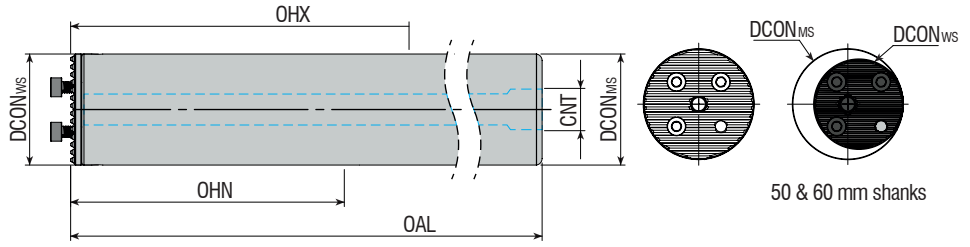

**Takım Kodu**  
**Ordering Code**  
Код для заказа

Stok  
Stock  
Наличие

Takım Ölçüleri (mm)  
Dimension (mm)  
Размеры (мм)

Yedek Parçaları / Spare Parts / Запасные части

Montaj Vidası  
Shim Screw  
Винт опорной пластины

Montaj Vida Anahtar  
Mounting Screw Key  
Монтажный винт шестигранной под шестигранник

Takım Kodu / Ordering Code / Код для заказа	Stok / Stock / Наличие	DCONMS	DCONWS	OAL	OHN	OHX	CNT	DCON / DMIN		Montaj Vidası / Shim Screw / Винт опорной пластины	Montaj Vida Anahtar / Mounting Screw Key / Монтажный винт шестигранной под шестигранник
								DCON	DMIN		
ATTB-D16-156-7D-H	○	16	16	156	55	92	G1/8	16	20	2525-M3X10	AAL-02-2.5
ATTB-D16-204-10D-H-E	○	16	16	204	96	140	G1/8	16	20		
ATTB-D20-200-7D-H	○	20	20	200	70	120	G1/4	20	25	M3.5X10	AAL-02-2.5
ATTB-D20-260-10D-H-E	○	20	20	260	120	180	G1/4	20	25		
ATTB-D25-255-7D-H	○	25	25	255	88	158	G1/4	25	32	2503-M4X12	AAL-03-3
ATTB-D25-330-10D-H	○	25	25	330	155	230	G1/4	25	32		
ATTB-D32-320-7D-H	○	32	32	320	100	192	G3/8	32	40	2504-M5X16	AAL-05-4
ATTB-D32-416-10D-H	○	32	32	416	192	288	G3/8	32	40		
ATTB-D40-408-7D-H	○	40	40	408	128	248	G1/2	40	50	2505-M6X16	AAL-07-5
ATTB-D40-528-10D-H	○	40	40	528	248	368	G1/2	40	50		
ATTB-D50-519-7D-H	●	50	40	519	168	318	G1/2	40	63	2505-M6X16	AAL-07-5
ATTB-D50-669-10D-H	○	50	40	669	318	468	G1/2	40	63		
ATTB-D60-628-7D-H	○	60	40	628	208	388	G3/4	40	80	2505-M6X16	AAL-07-5
ATTB-D60-808-10D-H	○	60	40	808	388	568	G3/4	40	80		

R: Sağ / Right / Правый L: Sol / Left / Левый

● Stokta / In Stock / В наличии ○ Stokta Yok / Non Stock Item / Нет в наличии

Sipariş Örneği / Ordering Example / Образец заказа

1 ad./pcs./шт. ATTB-D16-156-7D-H



new

KAPR=93°

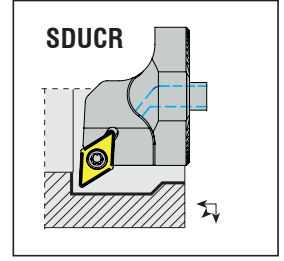
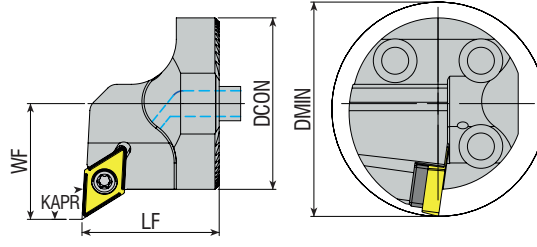

SDUCR

Takım Kodu  
Ordering Code  
Код для заказа

Stok  
Stock  
Наличие

Takım Ölçüleri (mm)  
Dimension (mm)  
Размеры (мм)

Kesici Uç  
Insert  
Пластина

Yedek Parçaları / Spare Parts / Запасные части

Sıkma Vidası  
Screw  
Зажимной винт

Aitlik  
Shim  
Опорная пластина

Aitlik Vidası  
Shim Screw  
Винт опорной пластины

Tork Anahtar  
Torx Key  
Торх Ключ

R	L	DCON	LF	WF	DMIN
○	○	16	20	11	20
○	○	20	20	13	25
○	○	25	23	17	32
○	○	32	32	22	40
●	●	40	32	27	50

Kesici Uç Insert Пластина	Sıkma Vidası Screw Зажимной винт	Aitlik Shim Опорная пластина	Aitlik Vidası Shim Screw Винт опорной пластины	Tork Anahtar Torx Key Торх Ключ
DC.T 0702..	4008-M2.5x6 4015-M3.5x11	-	-	80-T08
DC.T 11T3..	4015-M3.5x12 4015-M3.5x14	AADN-2-0001	AAV-08-M3.5x8 AAV-06-M3.5x11	80-T15

new

KAPR=95°

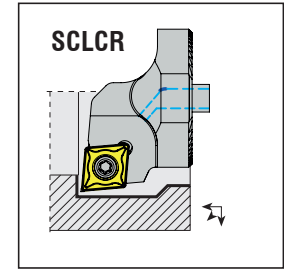
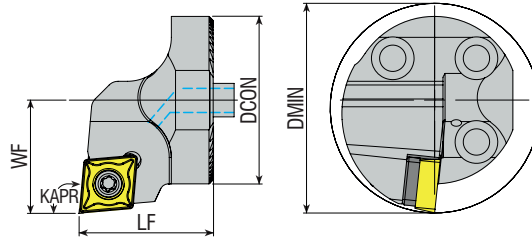

SCLCR

Takım Kodu  
Ordering Code  
Код для заказа

Stok  
Stock  
Наличие

Takım Ölçüleri (mm)  
Dimension (mm)  
Размеры (мм)

Kesici Uç  
Insert  
Пластина

Yedek Parçaları / Spare Parts / Запасные части

Sıkma Vidası  
Screw  
Зажимной винт

Aitlik  
Shim  
Опорная пластина

Aitlik Vidası  
Shim Screw  
Винт опорной пластины

Tork Anahtar  
Torx Key  
Торх Ключ

R	L	DCON	LF	WF	DMIN
○	○	16	20	11	20
○	○	20	20	13	25
○	○	25	23	17	32
○	○	32	32	22	40
●	●	40	32	27	50

Kesici Uç Insert Пластина	Sıkma Vidası Screw Зажимной винт	Aitlik Shim Опорная пластина	Aitlik Vidası Shim Screw Винт опорной пластины	Tork Anahtar Torx Key Торх Ключ
CC.T 0602..	4008-M2.5x6 4015-M3.5x9	-	-	80-T08
CC.T 09T3..	4015-M3.5x12	AACN-2-0001	AAV-08-M3.5x8	80-T15
CC.T 1204..	1020-M4.5x16	AACN-2-0003	AAV-07-M4.5x13	80-T20

R: Sağ / Right / Правый L: Sol / Left / Левый

● Stokta / In Stock / В наличии ○ Stokta Yok / Non Stock Item / Нет в наличии

Sipariş Örneği/Ordering Example/Образец заказа

1 ad./pcs./шт. ATTC-A16-SDUCR 07



KAPR=93°

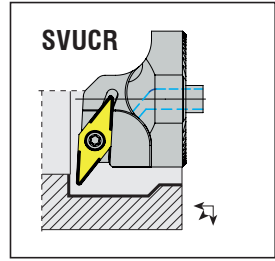
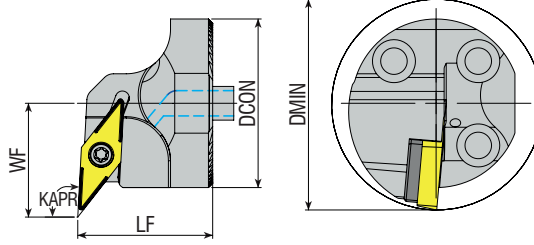

**Takım Kodu**  
**Ordering Code**  
Код для заказа

Stok Stock Наличие	TAKIM ÖLÇÜLERİ (MM) DIMENSION (MM) РАЗМЕРЫ (MM)					Kesici Uç Insert Пластина	Yedek Parçaları / Spare Parts / Запасные части				
	R	L	DCON	LF	WF		DMIN	SIKMA VIDASI SCREW ЗАЖИМНОЙ ВИНТ	Altlık Shim Опорная пластина	Altlık Vidası Shim Screw Винт опорной пластины	Tork Anahtar Torx Key Торх Ключ
ATTC-A20 SVUCR/L 11	○	○	20	20	15	27	VC.T 1103..	4008-M2.5x6	-	-	80-T08
ATTC-A25 SVUCR/L 11	○	○	25	23	17	32					
ATTC-A32 SVUCR/L 16	○	○	32	32	22	40	VC.T 1604..	4015-M3.5x14	AAVN-2-0002	AAV-06-M3.5x11	80-T15
ATTC-A40 SVUCR/L 16	●	●	40	32	27	50					



KAPR=93°

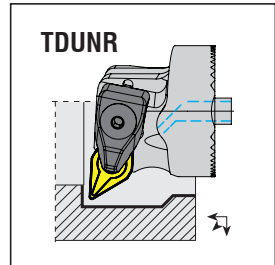
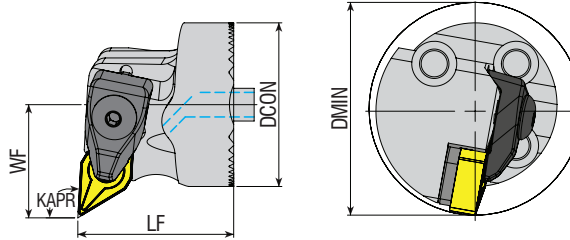

**Takım Kodu**  
**Ordering Code**  
Код для заказа

Stok Stock Наличие	Takım Ölçüleri (mm) Dimension (mm) Размеры (мм)					Kesici Uç Insert Пластина	Yedek Parçaları / Spare Parts / Запасные части							
	R	L	DCON	LF	WF		DMIN	Baskı Pabucu Wedge Clamp Прижим	Pabuç Vidası Clamp Screw Зажимной винт	Altlık Shim Опорная пластина	Altlık Vidası Shim Screw Винт опорной пластины	Sekman Ring Кольцо	Pu Stamp Шайба	Anahtar Allen Key Ключ
ATTC-A32 TDUNR/L 11	○	○	32	32	22	40	DNM. 1104..	ATK-01	AKV-01-M5x22	AADN -2-0001	AAV-04-M5x12	AS-01	ABPL-01	AAL-03-3
ATTC-A40 TDUNR/L 15	●	●	40	38	27	50	DNM. 1506..	ATK-02	AKV-30-M6x22	AADN -3-0001	AAV-02-M5x12			

R: Sağ / Right / Правый L: Sol / Left / Левый

● Stokta / In Stock / В наличии ○ Stokta Yok / Non Stock Item / Нет в наличии

Sipariş Örneği/Ordering Example/Образец заказа

1 Ad./Pcs./шт. ATTC-A20 SVUCR 11

**TIRLAMAZ TAKIMLARIN KARTUŞLARI**  
**ANTI VIBRATION TOOLS CARTRIDGES**  
 КАРТРИДЖИ ДЛЯ АНТИВИБРАЦИОННОЙ РАСТОЧНОЙ ДЕРЖАВКИ



KAPR=95°

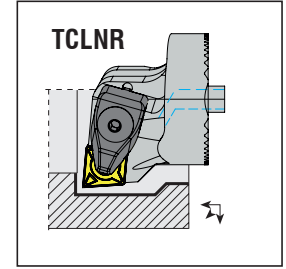
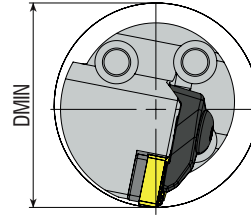
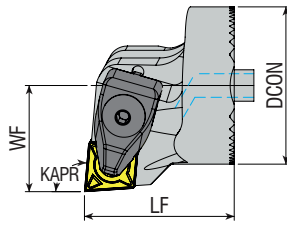

Takım Kodu Ordering Code Код для заказа	Stok Stock Наличие		Takım Ölçüleri (mm) Dimension (mm) Размеры (мм)				Kesici Uç Insert Пластина	Yedek Parçaları / Spare Parts / Запасные части						
	R	L	DCON	LF	WF	DMIN		Baskı Pabucu Wedge Clamp Прижим	Pabuç Vidası Clamp Screw Зажимной винт	Aitlik Shim Опорная пластина	Aitlik Vidası Shim Screw Винт опорной пластины	Sekman Ring Кольцо	Pul Stamp Шайба	Anahtar Allen Key Ключ
ATTC-A32 TCLNR/L 12	○	○	32	32	22	40	CNM. 1204..							
ATTC-A40 TCLNR/L 12	●	●	40	38	27	50								

**TIRLAMAZ TAKIMLARIN MERKEZLEME APARATI**  
**ANTI VIBRATION TOOLS CENTERING INSTRUMENT**  
 НАСАДКА ДЛЯ КАЛИБРОВАНИЯ КАРТРИДЖА АНТИВИБРАЦИОННОГО РЕЗЦА

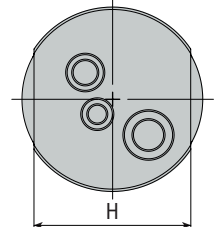
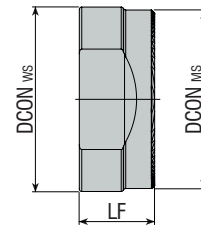

Takım Kodu Ordering Code Код для заказа	Stok Stock Наличие	Takım Ölçüleri (mm) Dimension (mm) Размеры (мм)				Gövde Tipi Boring Bars Борштанги
		DCONWS	DCONMS	LF	H	
ATTC-16-25	●	28	25	15	22	 ATTB-D16/D20/D25 ATTB-D32/D40/D50/D60
ATTC-32-60	●	53	40	20	35	

R: Sağ / Right / Правый L: Sol / Left / Левый  
 ● Stokta / In Stock / В наличии ○ Stokta Yok / Non Stock Item / Нет в наличии

Sipariş Örneği/Ordering Example/Образец заказа  
 1 ad./pcs./шт. ATTC-A32 TCLNR 12

**1 Montaj ve Ayarlama | Assembly and Adjusting | Сборка и установка**

Kartuş ve gövdenin montaj edilecek yüzeyleri, tutucunun iç kısmı temizlenmelidir. Aşağıdaki görselde A ve B konumlarına bakın.

The surface of the cartridge and the shank to be mounted, as well as the inner part of the toolholder should be cleaned. Check A and B in the image below.

Посадочные поверхности борштанги (А) и резцовой головки (В) должны быть очищены перед сборкой.

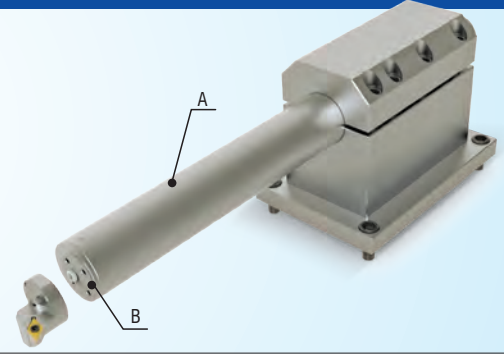
**2 Gövde Montajı | Assembly for the Shank | Резцедержатель**

Bağlama uzunluğu 4 L / D oranından az olmamalıdır. Tutucunun üst kısmını çıkartma yöntemiyle veya diğer tutma sıkma yöntemleriyle kullanmanızı öneririz (C tipi). Vidalı bağlama yöntemi kullanmayın. Uzun süre çalışırken lütfen içten soğutmayı kullanın.

The clamping length should not be less than 4 L/D ratio. Suggest using the clamping cover with opening method and other holding clamping methods. (Type C). Do not use screw clamping method. Use inner cooling please when working a long time.

Длина закрепления не менее 4 диаметров хвостовика. Резцедержатель должен обеспечивать большую площадь обхвата и concentricность (тип С). Закрепление борштанг винтом не допускается. Используйте внутренний подвод СОЖ непрерывно во время работы, а так же некоторое время до начала работы

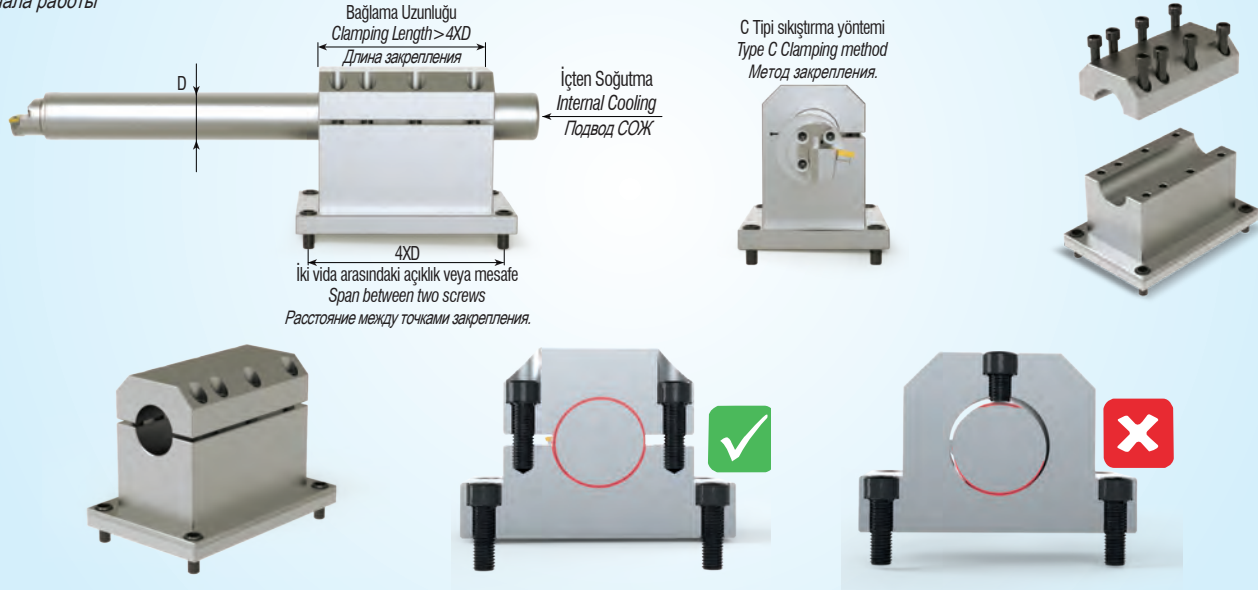
**3 Merkez Yüksekliğinin Ayarlanması | Adjusting the Height of Centre Assembly | Установка высоты центра**

Gövdeyi ilk kez montaj ederken merkez yüksekliği için özel kalibrasyon aparatı kullanılmalıdır. Önce gövdeyi tutucuya monte edin, ardından X ekseninde 0,01 tolerans içinde kalibre edin. Lütfen komparatör saati ile ayarlamayı yapın.

When mounting the body for the first time, a special calibration tool should be used for the center height. First mount the shank on the holder, then calibrate it within 0.01 tolerance on the X axis direction. Please make the adjustment with the dial indicator device.

Для большей жёсткости борштанги изготавливают с цилиндрическим хвостовиком. После монтажа борштанги её необходимо откалибровать. Установите насадку для калибрования картриджа и с помощью индикатора часового типа проконтролируйте точность установки вдоль оси "X" (необходимо добиться погрешность в пределах 10 мкм).

Kalibrasyon Yüzeyi  
Calibrating end face  
Плоская поверхность  
для калибровки.

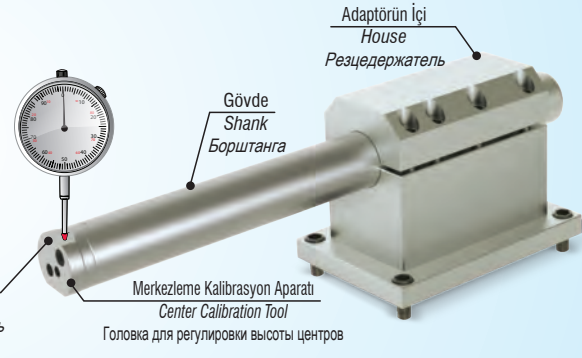
**4 Doğru Kartuş Montajı | Assembly the Right Cartridge | Сборка**

Yandaki şekle bakın:  
See the figure on the side:  
Смотри рисунок сбоку

Sol Yön Takım  
Left Hand  
Левое исполнение



Sağ Yön Takım  
Right Hand  
Правое исполнение



**Doğru Uç Seçimi / Choosing the Correct Insert / Рекомендации по подбору твердосплавных пластин**

Doğru kesici ucun seçilmesi, titreşim sönümlemenin genel başarısı üzerinde büyük bir etkiye sahiptir. Kesici ucun işleme stabilitesini artırabilmesinin ana yolu kesme kuvvetlerini en aza indirmektir. Titreşimleri ortadan kaldırmak için aşağıdaki adımlara uymanız gerekir: Mümkünse, her zaman kısa takımları kullanın. Aksi takdirde, titreşimi en aza indirmek için hızlarınızı azaltın.

*Choosing the correct insert can have a big influence on the overall success of vibration damping. The main way the insert can improve the machining stability is by minimizing the cutting forces. Following the guidelines below should be your first step to eliminate vibrations: If possible, use it always short drilling tools. Otherwise, reduce your speeds to minimize vibration.*

*Правильный подбор твердосплавной пластины может оказать большое влияние на снижение вибрации. Основной задачей для стабильной обработки является снижение усилий резания, а это зависит от правильного выбора пластины. Следуя приведенным ниже рекомендациям, Вы можете снизить вибрации во время обработки. Если есть возможность, всегда используйте инструмент как можно меньшей длины. В противном случае уменьшите скорость, чтобы минимизировать вибрацию.*

**A** Radyal kuvvetleri minimuma indirmek için mümkün olduğunca 90°'ye yakın bir giriş açılı takımı seçin.

*Choose an entry angle that is as close as possible to 90° to reduce the radial forces to a minimum.*

*Выбирайте угол в плане (KAPR) близкий к 90° - в этом случае радиальная сила резания будет ниже.*

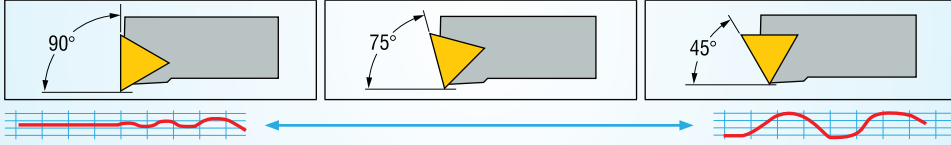
**B** Mümkün olan en küçük kesici uç açısını seçin. Böylece kesme kuvvetleri azalacak ve yüzey kalitesi artacak.

*Choose the smallest insert head angle possible. This will reduce overall cutting forces and increase the clearance.*

*Склонность к вибрациям растёт слева направо. С увеличением угла при вершине пластины увеличивается усилие резания.*

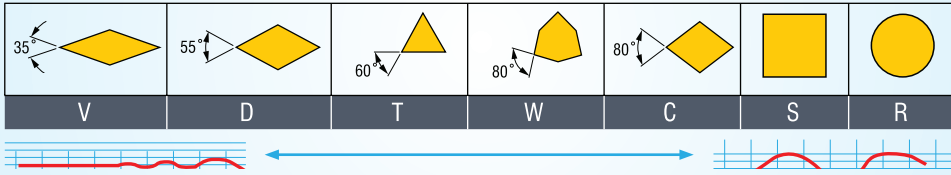
**C** Titreşimi azaltmak için olabildiğince en küçük radyüslü ucu seçmelisiniz.

*Choose a small nose radius to reduce the cutting forces and to enable machining in a lower depth of cut.*

*Меньший угол при вершине позволит снизить усилие резания, за счёт малых глубин резания и подачи.*

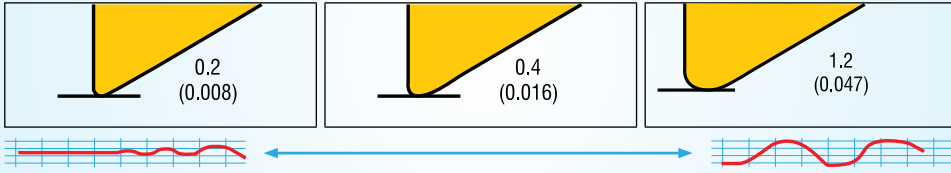
**D** İşleme derinliği (ap) radyüsten daha büyük olmalıdır.

*Machining depth (ap) should be larger than the nose radius.*

*Глубина резания должна превышать радиус при вершине.*

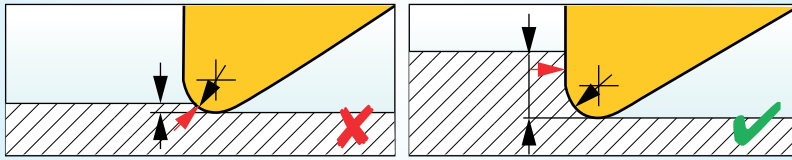
**E** Kesme kuvvetlerini azaltmak için daha pozitif geometriye sahip bir kesici uç kullanın.

*Use an insert with an overall positive geometry to reduce the cutting forces:*

*Используйте пластины с задними углами, что бы снизить силы резания.*

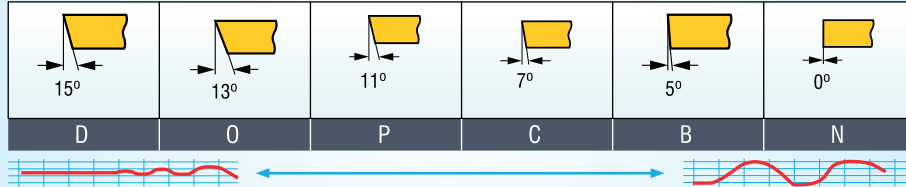
**F** Pozitif bir üst eğim geometrisi seçin:

*Choose a positive top rake geometry:*

*Выбирайте "стружколомы" (формы передней поверхности СМП) с большей величиной переднего угла.*

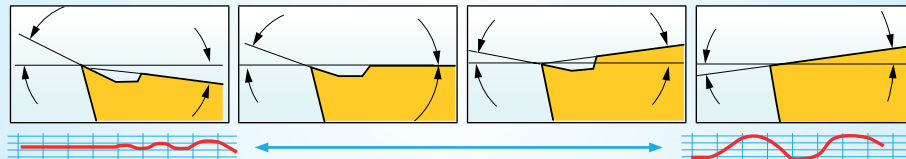
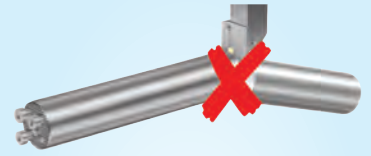
**G** For-dampened-straight-adaptor:

*L, kesildikten sonra min uzunluk*

*L, min length after cut off*

*L, минимальная длина после отрезания*

Ø	Kısa Tasarım Short Design Краткий дизайн 4-7x Ø (mm)	Uzun Tasarım Long Design Длинный дизайн 7-10x Ø (mm)
16	100	155
20	125	200
25	155	255
32	190	320
40	240	410
50	305	520
60	380	630



*konusulan*  
*the spoken kalite...*  
*quality...*

# KARTUŞLAR

KARTUŞLAR  
CARTRIDGE  
КАРТРИДЖИ





**S**

1

**T**

2

**F**

3

**C**

4

**R**

5

**12**

6

**C**

7

**A**

8

**16**

9

**1** Sıkma Tipi / Method of Mounting of Insert / Способ крепления пластины



Deliksiz Üstten Sıkma  
Top Clamping Without Hole  
Прижим сверху без отверстия

**C**



Delikten Levye ile Sıkma  
Hole Clamping (Lever Lock)  
Прижим рычагом за отверстие

**P**



Vida ile Sıkma  
Screw on Clamping  
Крепление винтом

**S**

**2** Uç Tipi / Type of Insert / Форма пластины



**C**



**S**



**T**

**3** Yanaşma Açısı / Tool Holder Shape Bar Geometry / Угол в плане

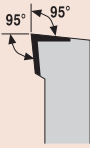

**L**



**S**



**F**

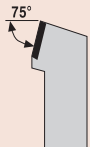

**R**



**K**



**G**



**W**



**T**

**4** Serbest Uç Açısı / Insert Clearance Angle / Задний угол пластины



**C**



**P**



**N**

**5** Kesme Yönü / Cutting Direction / Направление резания

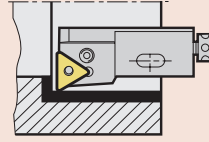

**R**

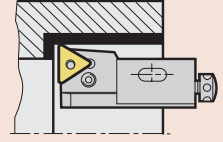

**L**

**6** Kesme Kenar Yüksekliği / Cutting Edge Height / Высота режущей кромки

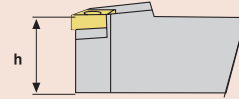

**7** Kartuş Kodu / Cartridge Code / Код картриджа

**C**  
(Kartuş / Cartridge Code / Код картриджа)

**8** Kartuş Tipi / Cartridge Type / Тип картриджа

**A**  
(ISO 5611)

**9** Kesme Kenar Uzunluğu / Cutting Edge Length / Длина режущей кромки



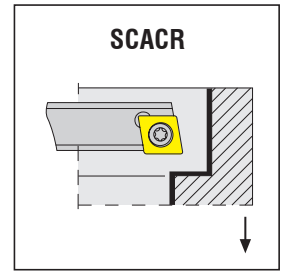
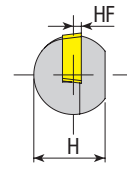
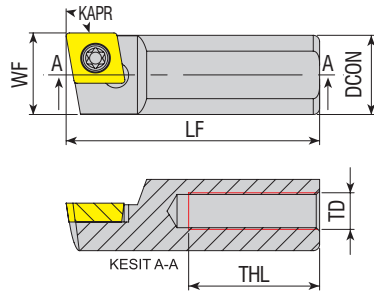

Takım Kodu Ordering Code Код для заказа	Stok Stock Наличие		Takım Ölçüleri (mm) Dimension (mm) Размеры (мм)							Kesici Uç Insert Пластина	Yedek Parçaları / Spare Parts / Залпасные части	
	R	L	DCON	H	LF	THL	HF	WF	TD		Sıkma Vidası Screw Зажимной винт	Tork Anahtar Torx Key Торк Ключ
S10X SCACR/L 06	●	●	10	9	25	10	1	10.3	M5x0.8	CC.T 0602..	4008-M2.5x6	80-T08
S10A SCACR/L 06	●	●	10	9	32	15	1	10.3	M5x0.8			
S1018 SCACR/L 06	○	●	10	9	18	8	1	9.8	M5x0.8			
S1065 SCACR/L 06	○	●	10	9	65	25	1	10.3	M5x0.8			
S10C SCACR/L 06	●	●	10	9	50	25	1	10.3	M5x0.8			
S12B SCACR/L 06	●	●	12	11	40	25	1	12.3	M5x0.8			
S12D SCACR/L 06	●	●	12	11	60	25	1	12.3	M5x0.8	CC.T 09T3..	4015-M3.5x8	80-T15
S12D SCACR/L 09	●	●	12	11	60	25	2	12.2	M5x0.8			
S1265 SCACR/L 09	○	●	12	11	65	25	2	12.3	M5x0.8			
S12H SCACR/L 09	●	●	12	11	100	25	2	12.2	M5x0.8			
S15C SCACR/L 09	●	●	15	14	50	25	2	15.3	M8x1.25			
S1554 SCACR/L 09	○	●	15	14	54	25	2	15.3	M8x1.25			
S15E SCACR/L 09	○	●	15	14	70	45	2	15.3	M8x1.25			
S15D SCACR/L 09	○	●	15	14	60	30	2	15.3	M8x1.25			
S16A SCACR/L 09	●	●	16	15	32	15	2	16.5	M6x1			
S16B SCACR/L 09	●	●	16	15	40	20	2	16.5	M6x1			
S16C SCACR/L 09	○	●	16	15	50	25	2	16.5	M6x1			
S16D SCACR/L 09	●	●	16	15	60	30	2	16.5	M6x1			
S16E SCACR/L 09	○	●	16	15	70	30	2	16.5	M6x1			
S16G SCACR/L 09	●	●	16	15	90	30	2	16.5	M6x1			
S16H SCACR/L 09	○	●	16	15	100	35	4	16.5	M6x1			
S1868 SCACR/L 09	○	●	18	17	68	30	2	18.5	M8x1.25			
S18E SCACR/L 09	●	●	18	17	70	30	2	18.5	M8x1.25			
S1888 SCACR/L 09	○	●	18	17	88	30	2	18.5	M8x1.25			
S18105 SCACR/L 09	○	●	18	17	105	30	2	18.5	M8x1.25			
S18175 SCACR/L 09	○	●	18	17	175	30	2	18.5	M8x1.25			
S20E SCACR/L 09	●	●	20	18.3	70	30	2	20.5	M6x1	CC.T 1204..	1020-M5x11	80-T20
S20E SCACR/L 12	●	●	20	18.3	70	30	2	20.5	M6x1			
S20H SCACR/L 12	●	●	20	18.3	100	30	2	20.5	M6x1			

R: Sağ / Right / Правый L: Sol / Left / Левый  
● Stokta / In Stock / В наличии ○ Stokta Yok / Non Stock Item / Нет в наличии

Sipariş Örneği/Ordering Example/Образец заказа  
1 ad./pcs./шт. S10X SCACR 06

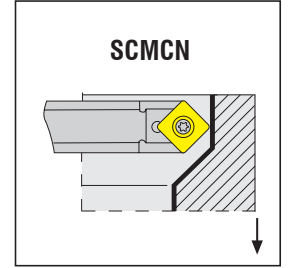
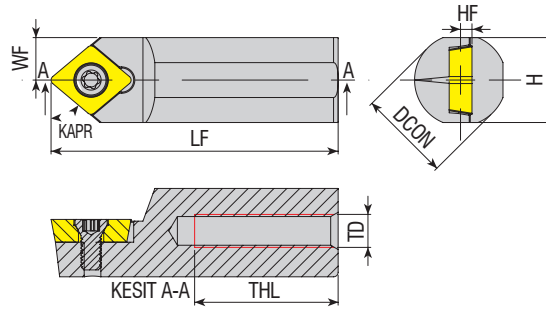

Takım Kodu Ordering Code Код для заказа	Stok Stock Наличие	Takım Ölçüleri (mm) Dimension (mm) Размеры (мм)							Kesici Uç Insert Пластина	Yedek Parçaları / Spare Parts / Запасные части		
		DCON	H	LF	THL	HF	WF	TD		Sıkma Vidası Screw Зажимной винт	Tork Anahtar Torx Key Торх Ключ	
S10X SCMCN 06	●	10	9	25	10	1	5	M5x0.8	CC.T 0602..	4008-M2.5x6	80-T08	
S12D SCMCN 06	●	12	11	60	25	1	6	M5x0.8				
S16C SCMCN 09	●	16	15	50	25	2	8	M6x1	CC.T 09T3..	4015-M3.5x11	80-T15	
S16D SCMCN 09	●	16	15	60	25	4	8	M6x1				

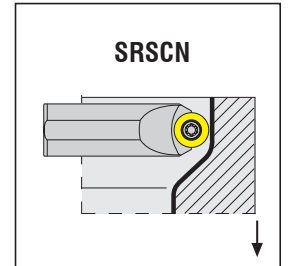
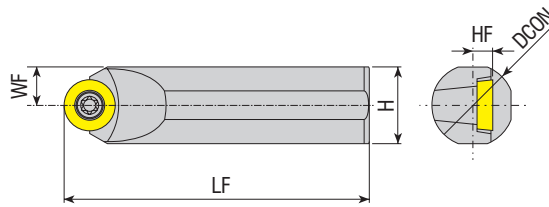

Takım Kodu Ordering Code Код для заказа	Stok Stock Наличие	Takım Ölçüleri (mm) Dimension (mm) Размеры (мм)					Kesici Uç Insert Пластина	Yedek Parçaları / Spare Parts / Запасные части		
		DCON	H	WF	HF	LF		Sıkma Vidası Screw Зажимной винт	Tork Anahtar Torx Key Торх Ключ	
S12D SRSCN 10	●	12	11	6	3.9	60	RC.. 10T3..	4015-M3.5x9	80-T15	
S14D SRSCN 10	●	14	13	7	3.9	60				4015-M3.5x11
S16D SRSCN 10	●	16	15	8	3.9	60				

R: Sağ / Right / Правый L: Sol / Left / Левый  
● Stokta / In Stock / В наличии ○ Stokta Yok / Non Stock Item / Нет в наличии

Sipariş Örneği/Ordering Example/Образец заказа  
1 ad./pcs./шт. S10X SCMCN 06

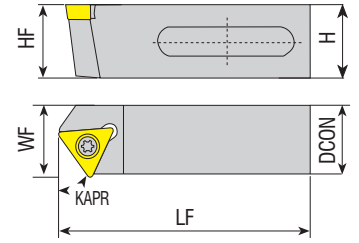

Takım Kodu Ordering Code Код для заказа	Stok Stock Наличие		Takım Ölçüleri (mm) Dimension (mm) Размеры (мм)					Kesici Uç Insert Пластина	Yedek Parçaları / Spare Parts / Запасные части		
	R	L	DCON	H	HF	LF	WF		Sıkma Vidası Screw Зажимной винт	Tork Anahtar Torx Key Торх Ключ	
STXCR/L 2020 B16	○	●	20	20	20	45	20	TC.. 16T3..	4015-M3.5x11	80-T15	
STXCR/L 2020 E16	○	●	20	20	20	70	20				
STXCR/L 2020 B16-SA	○	●	20	10	20	45	20				
STXCR/L 2020 E16-SA	○	●	20	10	20	70	20				
STXCR/L 2020 B16-PL	○	●	20	10	20	45	20				
STXCR/L 2020 E16-PL	○	●	20	10	20	70	20				
STXCR/L 2020 H16-PL	○	●	20	10	20	100	20				

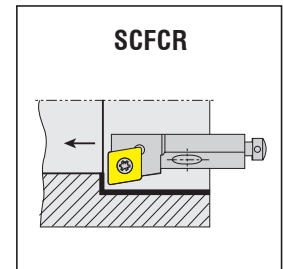
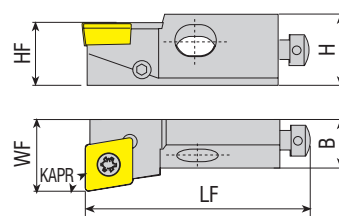
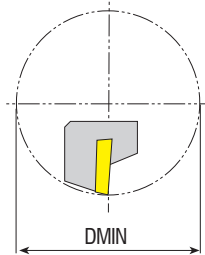

Takım Kodu Ordering Code Код для заказа	Stok Stock Наличие		Takım Ölçüleri (mm) Dimension (mm) Размеры (мм)						Kesici Uç Insert Пластина	Yedek Parçaları / Spare Parts / Запасные части			
	R	L	HF	H	B	LF	WF	DMIN		Altlık Shim Опорная пластина	Altlık Vidası Shim Screw Винт опорной пластины	Sıkma Vidası Screw Зажимной винт	Tork Anahtar Torx Key Торх Ключ
SCFCR/L 06CA 06	●	●	6	8.5	6	25	8	≥20	CC.T 060204	-	-	4008-M2.5x6	80-T08
SCFCR/L 08CA 06	●	●	8	11	8	32	10	≥25					
SCFCR/L 10CA 09	●	●	10	15	11	50	14	≥40					
SCFCR/L 12CA 12	●	○	12	20	15	55	20	≥50					
SCFCR/L 16CA 12	●	●	16	21	20	63	25	≥60					
									CC.T 120408	AAVN-2-0003	AAV-10-M4.5x8	4020-M4.5x12	80-T20

R: Sağ / Right / Правый L: Sol / Left / Левый  
● Stokta / In Stock / В наличии ○ Stokta Yok / Non Stock Item / Нет в наличии

Sipariş Örneği/Ordering Example/Образец заказа  
1 ad./pcs./шт. STXCR 2020 B16

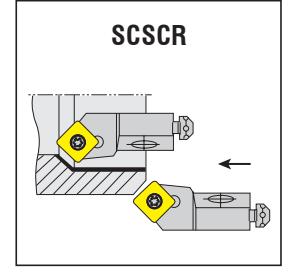
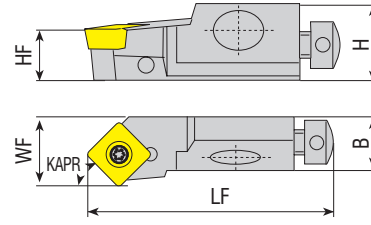
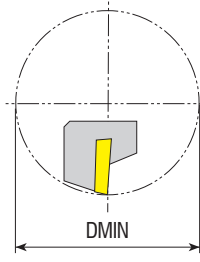

Takım Kodu Ordering Code Код для заказа	Stok Stock Наличие		Takım Ölçüleri (mm) Dimension (mm) Размеры (мм)						Kesici Uç Insert Пластина	Yedek Parçaları / Spare Parts / Запасные части			
	R	L	HF	H	B	LF	WF	DMIN		Altlık Shim Опорная пластина	Altlık Vidası Shim Screw Винт опорной пластины	Sıkma Vidası Screw Зажимной винт	Tork Anahtar Torx Key Торх Ключ
SCSCR/L 06CA 06	●	○	6	8	6	30	8	≥20		-	-	4008-M2.5x6	80-T08
SCSCR/L 10CA 09	●	○	10	15	11	50	14	≥40		-	-	4015-M3.5x9	80-T15
SCSCR/L 12CA 12	○	○	12	20	15	55	20	≥50		-	-	1020-M5x11	80-T20

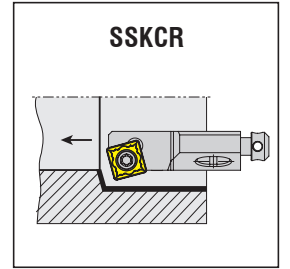
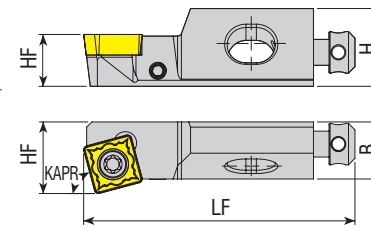
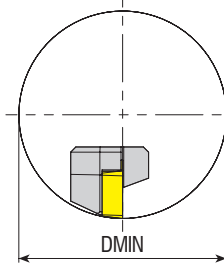

Takım Kodu Ordering Code Код для заказа	Stok Stock Наличие		Takım Ölçüleri (mm) Dimension (mm) Размеры (мм)						Kesici Uç Insert Пластина	Yedek Parçaları / Spare Parts / Запасные части			
	R	L	HF	H	B	LF	WF	DMIN		Altlık Shim Опорная пластина	Altlık Vidası Shim Screw Винт опорной пластины	Sıkma Vidası Screw Зажимной винт	Tork Anahtar Torx Key Торх Ключ
SSKCR/L 10CA 09	●	○	10	15	11	50	14	≥40		-	-	4015-M3.5x9	80-T15
SSKCR/L 12CA 12	●	○	12	20	15	55	20	≥50		-	-	1020-M5x11	80-T20

R: Sağ / Right / Правый L: Sol / Left / Левый  
● Stokta / In Stock / В наличии ○ Stokta Yok / Non Stock Item / Нет в наличии

Sipariş Örneği/Ordering Example/Образец заказа  
1 ad./pcs./шт. SCSCR 06CA 06

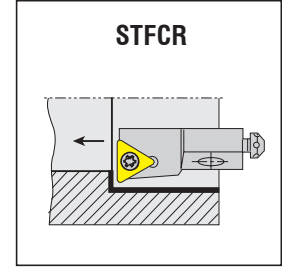
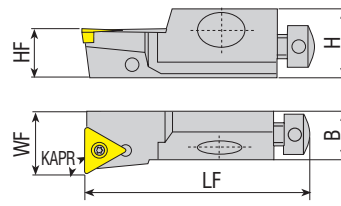
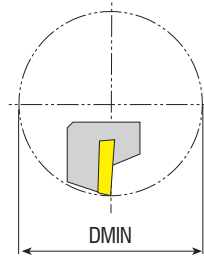

Takım Kodu Ordering Code Код для заказа	Stok Stock Наличие		Takım Ölçüleri (mm) Dimension (mm) Размеры (мм)						Kesici Uç Insert Пластина	Yedek Parçaları / Spare Parts / Запасные части			
	R	L	HF	H	B	LF	WF	DMIN		Altık Shim Опорная пластина	Altık Vidası Shim Screw Винт опорной пластины	Sıkma Vidası Screw Зажимной винт	Tork Anahtar Torx Key Торх Ключ
STFCR/L 08CA 09	●	●	8	11	8	32	10	≥25	TC.T 090204	-	-	3007-M2.2x5	80-T07
STFCR/L 10CA 11	●	●	10	15	11	50	14	≥40	TC.T 110204	-	-	4008-M2.5x6	80-T08
STFCR/L 12CA 16	●	○	12	20	15	55	20	≥50	TC.T 16T308	-	-	4015-M3.5x11	80-T15
STFCR/L 16CA 16	●	●	16	21	20	63	25	≥60		AATN-2-0001	AAV-06-M3.5x11	4015-M3.5x14	

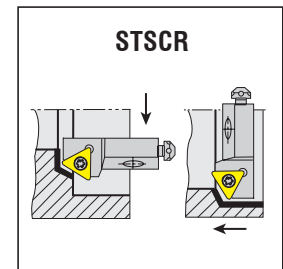
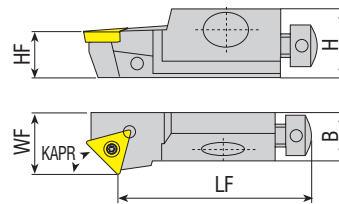
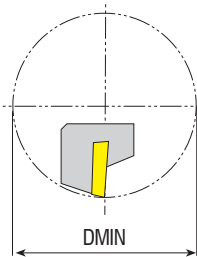

Takım Kodu Ordering Code Код для заказа	Stok Stock Наличие		Takım Ölçüleri (mm) Dimension (mm) Размеры (мм)						Kesici Uç Insert Пластина	Yedek Parçaları / Spare Parts / Запасные части			
	R	L	HF	H	B	LF	WF	DMIN		Altık Shim Опорная пластина	Altık Vidası Shim Screw Винт опорной пластины	Sıkma Vidası Screw Зажимной винт	Tork Anahtar Torx Key Торх Ключ
STSCR/L 08CA 09	●	○	8	11	8	28	10	≥25	TC.T 090204	-	-	3007-M2.2x5	80-T07
STSCR/L 10CA 11	●	●	10	15	11	44	14	≥40	TC.T 110204	-	-	4008-M2.5x6	80-T08
STSCR/L 12CA 16	●	○	12	20	15	47	20	≥50	TC.T 16T308	-	-	4015-M3.5x11	80-T15

R: Sağ / Right / Правый L: Sol / Left / Левый  
● Stokta / In Stock / В наличии ○ Stokta Yok / Non Stock Item / Нет в наличии

Sipariş Örneği/Ordering Example/Образец заказа  
1 ad./pcs./шт. STFCR 08CA 09

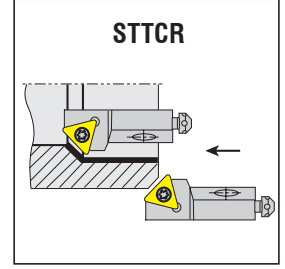
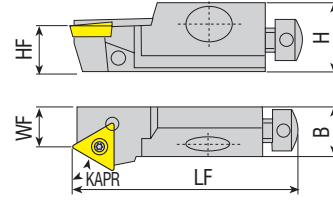
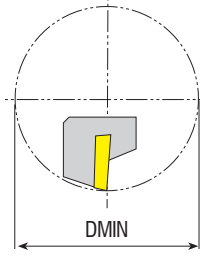

Takım Kodu Ordering Code Код для заказа	Stok Stock Наличие		Takım Ölçüleri (mm) Dimension (mm) Размеры (мм)						Kesici Uç Insert Пластина	Yedek Parçaları / Spare Parts / Запасные части			
	R	L	HF	H	B	LF	WF	DMIN		Altık Shim Опорная пластина	Altık Vidası Shim Screw Винт опорной пластины	Sıkma Vidası Screw Зажимной винт	Tork Anahtar Torx Key Торх Ключ
STTCR/L 08CA 09	●	●	8	11	8	32	6	≥25		-	-	3007-M2.2x5	80-T07
STTCR/L 10CA 11	●	●	10	15	11	50	9	≥40		-	-	4008-M2.5x6	80-T08

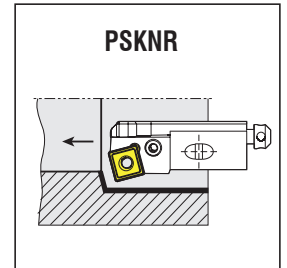
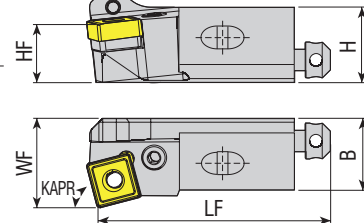
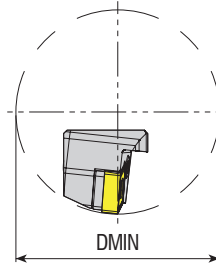

Takım Kodu Ordering Code Код для заказа	Stok Stock Наличие		Takım Ölçüleri (mm) Dimension (mm) Размеры (мм)						Kesici Uç Insert Пластина	Yedek Parçaları / Spare Parts / Запасные части				
	R	L	HF	H	B	LF	WF	DMIN		Levye Lever Рычаг	Levye Vidası Lever Screw Винт рычага	Altık Shim Опорная пластина	Altık Yayı Shim Spring Втулка рычага	Anahtar Allen Key Ключ
PSKNR/L 16CA 12	●	●	16	21	20	63	25	≥60		APL-02	ALV-08-M8x16	AASN-3-0004	AAV-02	AAL-02-2.5

R: Sağ / Right / Правый L: Sol / Left / Левый  
● Stokta / In Stock / В наличии ○ Stokta Yok / Non Stock Item / Нет в наличии

Sipariş Örneği/Ordering Example/Образец заказа  
1 ad./pcs./шт. STTCR 08CA 09

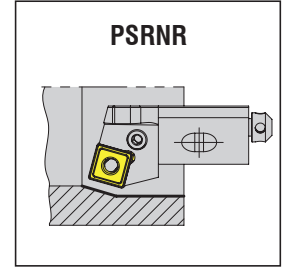
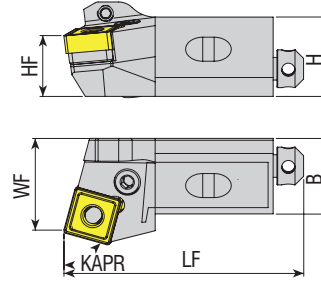
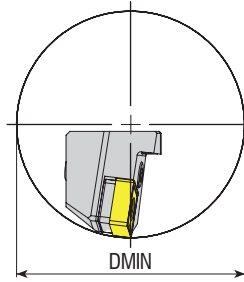

**Takım Kodu**  
**Ordering Code**  
**Код для заказа**

Stok Stock Наличие	Takım Ölçüleri (mm) Dimension (mm) Размеры (мм)								Kesici Uç Insert Пластина	Yedek Parçaları / Spare Parts / Запасные части				
	R	L	HF	H	B	LF	WF	DMIN		Levye Lever Рычаг	Levye Vidası Lever Screw Винт рычага	Altlık Shim Опорная пластина	Altlık Yayı Shim Spring Втулка рычага	Anahtar Allen Key Ключ
○ ●			16	21	20	63	25	≥60						
<b>PSRNR/L 16CA 12</b>	○ ●		16	21	20	63	25	≥60	<b>SNM.120408</b>	<b>APL-02</b>	<b>ALV-03-M8x19</b>	<b>AASN-3-0004</b>	<b>AAY-02</b>	<b>AAL-03-3</b>

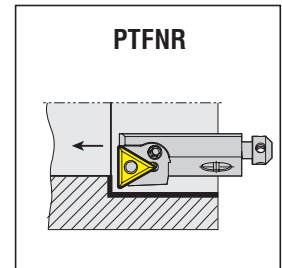
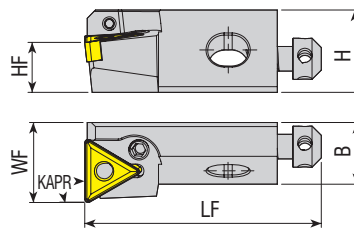
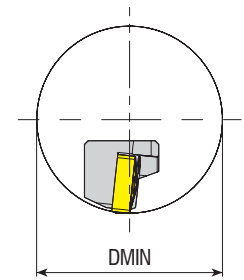

**Takım Kodu**  
**Ordering Code**  
**Код для заказа**

Stok Stock Наличие	Takım Ölçüleri (mm) Dimension (mm) Размеры (мм)								Kesici Uç Insert Пластина	Yedek Parçaları / Spare Parts / Запасные части				
	R	L	HF	H	B	LF	WF	DMIN		Levye Lever Рычаг	Levye Vidası Lever Screw Винт рычага	Altlık Shim Опорная пластина	Altlık Yayı Shim Spring Втулка рычага	Anahtar Allen Key Ключ
● ●	● ●		12	20	15	47	20	≥50						
<b>PTFNR/L 12CA 16</b>	● ●		12	20	15	47	20	≥50	<b>TNM.160408</b>	<b>APL-08</b>	<b>ALV-07-M6x13</b>	-	<b>AAY-07</b>	<b>AAL-02-2.5</b>
<b>PTFNR/L 16CA 16</b>	● ○		16	21	20	63	25	≥60		<b>APL-01</b>	<b>ALV-01-M6x14</b>	<b>AATN-3-0025</b>	<b>AAY-01</b>	

R: Sağ / Right / Правый L: Sol / Left / Левый

● Stokta / In Stock / В наличии ○ Stokta Yok / Non Stock Item / Нет в наличии

Sipariş Örneği/Ordering Example/Образец заказа  
1 ad./pcs./шт. PSRNR 16CA 12



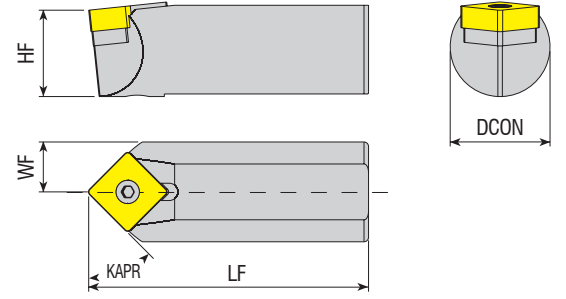

Takım Kodu Ordering Code Код для заказа	Stok Stock Наличие	Takım Ölçüleri (mm) Dimension (mm) Размеры (мм)				Kesici Uç Insert Пластина	Yedek Parçaları / Spare Parts / Запасные части				
		DCON	HF	LF	WF		Altlık Shim Опорная пластина	Sıkma Vidası Screw Зажимной винт	Baskı Parçası Wedge Clamp Прижим	Baskı Vidası Clamp Screw Зажимной винт	Tork Anahtar Torx Key Торх Ключ
<b>S22D PSDNN 12C</b>	●	22	19.5	65	11						
						<b>SNM. 1204..</b>	AASN-20020	AEV-01-M6x16	ACK-05	4015-M4x11	AAL-02-2.5

R: Sağ / Right / Правый L: Sol / Left / Левый

● Stokta / In Stock / В наличии ○ Stokta Yok / Non Stock Item / Нет в наличии

Sipariş Örneği/Ordering Example/Образец заказа  
1 ad./pcs./шт. S22D PSDNN 12C

KARTUŞLARIN YEDEK PARÇALARI  
SPARE PARTS OF CARTRIDGE  
ЗАПАСНЫЕ ЧАСТИ К КАРТРИДЖАМ

Takım Kodu Ordering Code Код для заказа	Yedek Parçaları / Spare Parts / Запасные части					
	Eksenel Ayar Vida Axial Adj. Screw Осевой регулировочный винт	Radyal Ayar Vida Radial Adj. Screw Радиальный регулировочный винт	Radyal Ayar Vida Anahtar Radial Adj. Screw Allen Key Шестигранный ключ для крепления радиального винта	Montaj Vida Mounting Screw Монтажный винт	Montaj Vida Anahtar Mounting Screw Allen Key Монтажный винт оголовкой под шестигранник	
<b>SCFCR/L</b>	06CA 06	2600-M4x9.5	2715-M3x5	AAL-09-1.5	AKV-23-M4x10	AAL-03-3
<b>SCSCR/L</b>	08CA 06	2600-M4x9.5	2715-M3x5	AAL-09-1.5	AKV-23-M4x10	AAL-03-3
<b>SSKCR/L</b>	10CA 09	2600-M5x13	2702-M4x10	AAL-01-2	2505-M6x16	AAL-03-3
	12CA 12	2600-M5x13	2702-M4x10	AAL-01-2	2505-M6x16	AAL-03-3
	16CA 12	2600-M6x18	2725-M5x12	AAL-02-2.5	2005-M8x25	AAL-07-5
<b>STSCR/L</b>	08CA 09	2600-M4x9.5	2715-M3x5	AAL-09-1.5	AKV-23-M4x10	AAL-03-3
<b>STTCR/L</b>	10CA 11	2600-M5x13	2702-M4x10	AAL-01-2	2505-M6x16	AAL-03-3
<b>STFCR/L</b>	12CA 16	2600-M5x13	2702-M4x10	AAL-01-2	2505-M6x16	AAL-03-3
	16CA 16	2600-M6x18	2725-M5x12	AAL-02-2.5	2005-M8x25	AAL-07-5
<b>PTFNR/L</b>	12CA 16	2600-M5x13	2702-M4x4	AAL-01-2	2505-M6x16	AAL-03-3
<b>PSKNR/L</b>	16CA 16	2600-M6x18	2725-M5x6	AAL-02-2.5	2005-M8x25	AAL-07-5
<b>PSRNR/L</b>	16CA 12	2600-M6x18	2725-M5x6	AAL-02-2.5	2005-M8x25	AAL-07-5



Takım Kodu Ordering Code Код для заказа	Stok Stock Наличие	Ölçü Aralığı (mm) Boring Range (mm) Диапазон растачивание (мм)					Kartuşlar Cartridge Картриджи	Gövde Takım Kodu Body Tool Code Код головки	Teknik Çizim Technical Draw Технический эскиз
		D max		D min		Max (D dış-D iç) (D out-D in)			
		D iç D in	D dış D out	D iç D in	D dış D out				
ACPBT-1	●	27-52	52	18-36	36	27	ÖTG-K-120-20		
ACPBT-2	●	27-49	52	25-36	36	27			
ACPBT-3	●	48-75	75	41	42	27			
ACPBT-4	●	51-75	75	51	52	27			
ACPBT-5	●	22-35	35	22	23	27			
ACPBT-6	●	15-35	35	15	16	27			
ACPBT-7	●	49-53	75	32-36	36	27			
ACPBT-8	●	49	75	33-37	37	27			

Takım Kodu Ordering Code Код для заказа	Stok Stock Наличие	Ölçü Aralığı (mm) Boring Range (mm) Диапазон растачивание (мм)					Kartuşlar Cartridge Картриджи	Gövde Takım Kodu Body Tool Code Код головки	Teknik Çizim Technical Draw Технический эскиз
		D1		D2		Max (D dış-D iç) (D out-D in)			
		D max	D min	D max	D min				
ACPBT-9	●	38	24	15	1	-	ÖTG-K-120-20		
ACPBT-10	●	78	64	43	29	-			

R: Sağ / Right / Правый L: Sol / Left / Левый

● Stokta / In Stock / В наличии ○ Stokta Yok / Non Stock Item / Нет в наличии

Sipariş Örneği / Ordering Example / Образец заказа

1 ad./pcs./шт. ACPBT-1



*konusulan*  
*the spoken kalite...*  
*quality...*

# DİŞ AÇMA

DİŞ AÇMA TAKIMLARI  
THREADING TOOLHOLDERS  
РЕЗЬБОНАРЕЗНЫЕ ДЕРЖАВКИ





**S** **E** **R** **25 25** **M** **16** **C**

**1** Sıkma Tipi / Method of Mounting of Insert  
 Тип крепления пластины угла наклона пластины

S: Vida Sıkmalı  
 S: Screw Clamping / S Крепление винтом  
 T: Vida Sıkmalı Helis Açılı  
 T: Screw Clamping with Helix Angle  
 T: Крепление винтом с углом наклона винтовой линии

**2** İşlem Tipi / Application  
 Применение

E: Dış / External  
 Нарезание для наружной резьбы  
 I: İç / Internal /  
 Для наружной резьбы

**3** Kesme Yönü  
 Cutting Direction  
 Направление резания

R: Sağ Yan  
 Right-Hand  
 R: Правый  
 L: Sol Yan  
 Left-Hand  
 L: Левый

**4** Takım Malzemesi / Type of Boring / Сталь Инструмента

"A" Yüksek çelik gövde soğutma suyu kanallı / "A" Solid steel with coolant hole  
 "A" Расточная державка из твердой стали с подвожом СОЖ  
 "E" Çelik başlıkla sert metal gövde ve soğutma suyu kanallı / "E" Carbide bar with fixed steel head and coolant hole  
 "E" Расточная державка из твердосплавного карбида с подвожом СОЖ  
 "C" Karbür Şaft / "C" Carbide shank / "C" Расточная державка из твердосплавного карбида  
 "S" Çelik Şaft / "S" Steel shank / "S" Расточная державка из твердой стали

**4-5** Dış Çap Şaft Ölçüleri / External Shank Size  
 Сечение державки

Şaft / Shank / Размеры : hxb  
 2525 - 25 x 25 mm

**5** Şaft Çapı / Shank Diameter  
 Диаметр хвостовика

**6** Şaft Boyu / Shank Length / Длина державки

A - 32	H - 100	Q - 180	x-special
B - 40	J - 110	R - 200	
C - 50	K - 125	S - 250	
D - 60	L - 140	T - 300	
E - 70	M - 150	U - 350	
F - 80	N - 160	V - 400	
G - 90	P - 170	W - 450	

**7** Elmas Ölçüsü / Insert Size  
 Размер пластины

l (mm)	d
06	5/32"
08	3/16"
11	1/4"
16	3/8"
22	1/2"
27	5/8"

**8** Baskı Pabucu  
 Wedge Clamp  
 Прижим

**S** **I** **R** **S** **25** **R** **16** **C**

**DIŞ ÇAP DIŞ AÇMA KATERLERİ**  
**EXTERNAL THREADING TOOLHOLDERS**  
**ДЕРЖАВКА ДЛЯ НАРЕЗАНИЯ НАРУЖНОЙ РЕЗЬБЫ**

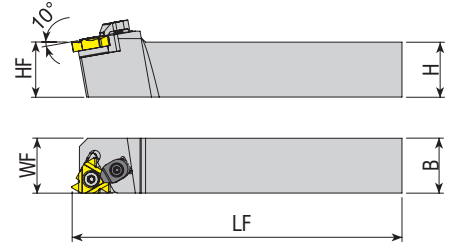
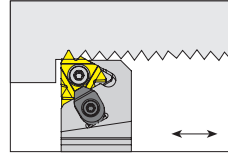
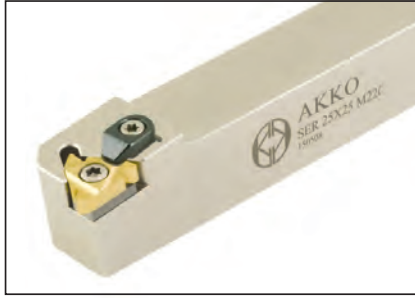

Takım Kodu Ordering Code Код для заказа	Stok Stock Наличие		Takım Ölçüleri (mm) Dimension (mm) Размеры (мм)				Kesici Uç Insert Пластина	Yedek Parçaları / Spare Parts / Запасные части					
	R	L	HF=H	B	LF	WF		Sıkma Vidası Screw Зажимной винт	Altlık Shim Опорная пластина	Altlık Vidası Shim Screw Винт опорной пластины	Baskı Parçası Wedge Clamp Прижим	Baskı Vidası Clamp Screw Зажимной винт	Tork Anahtar Torx Key Торх Ключ
SER/L 0808 E11	●	●	08	08	70	11	11 ER/EL	4008-M2.5x6	-	-	-	-	80-T08
SER/L 1010 E11	●	●	10	10	70	11							
SER/L 1212 F11	●	●	12	12	80	12							
SER/L 1616 H11	●	●	16	16	100	16							
SER/L 2020 H11	●	●	20	20	100	20							
SER/L 1616 H16C	●	●	16	16	100	16	16 ER/EL (0.35 - 3) ISO METRIC	4015-M3.5x14	AATN-2-0020	AAV-06-M3.5x11	ACK-05	4015 M4x11	80-T15
SER/L 2020 K16C	●	●	20	20	125	20							
SER/L 2525 M16C	●	●	25	25	150	25							
SER/L 3232 P16C	●	●	32	32	170	32	22 ER/EL (3.5 - 4.5) ISO METRIC	1020-M4.5x16	AATN-2-0004	AAV-07-M4.5x13	ACK-05	4015 M4x11	80-T20
SER/L 2525 M22C	●	●	25	25	150	25							
SER/L 3232 P22C	●	●	32	32	170	32	16 ER/L (1.5-3 TR)	4015-M3.5x14	-	-	-	-	80-T15
SER/L 4040 S22C	●	●	40	40	250	40							
SER/L 2525 M16C-T	●	●	25	25	150	25	22 ER/L (4-6 TR)	1020-M4.5x16	-	-	-	-	80-T20
SER/L 2020 K16C-S	●	●	20	20	125	25	SNDVK 166 ER/L16	4015-M3.5x14	AATN-2-0020	AAV-06-M3.5x11	-	-	80-T15
SER/L 2525 M16C-S	●	●	25	25	150	31							
SER/L 3232 P16C-S	●	●	32	32	170	38.5							

**DIŞ ÇAP DIŞ AÇMA İSVİÇRE TİPİ KAYAR OTOMAT MAKİNA KATERLERİ**  
**EXTERNAL THREADING TOOLHOLDERS FOR SWISS TYPE SLIDING AUTOMATIC LATHES**  
**ДЕРЖАВКА ДЛЯ НАРЕЗАНИЯ НАРУЖНОЙ РЕЗЬБЫ ДЛЯ СТАНКОВ-АВТОМАТОВ ШВЕЙЦАРСКОГО ТИПА**

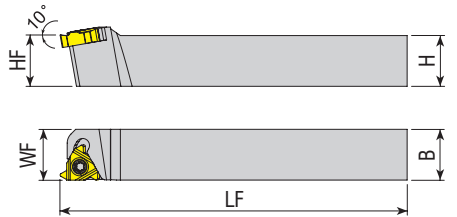
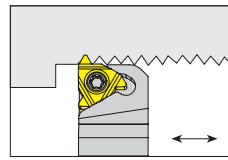

Takım Kodu Ordering Code Код для заказа	Stok Stock Наличие		Takım Ölçüleri (mm) Dimension (mm) Размеры (мм)				Kesici Uç Insert Пластина	Yedek Parçaları / Spare Parts / Запасные части					
	R	L	HF=H	B	LF	WF		Sıkma Vidası Screw Зажимной винт	Altlık Shim Опорная пластина	Altlık Vidası Shim Screw Винт опорной пластины	Baskı Parçası Wedge Clamp Прижим	Baskı Vidası Clamp Screw Зажимной винт	Tork Anahtar Torx Key Торх Ключ
SER/L 1010 K11-S	●	●	10	10	125	10	11 ER/EL	4008-M2.5x6	-	-	-	-	80-T08
SER/L 1212 K11-S	●	●	12	12	125	12							

R: Sağ / Right / Правый L: Sol / Left / Левый ● Stokta / In Stock / В наличии ○ Stokta Yok / Non Stock Item / Нет в наличии  
 Takımlar standart 1.5° helis açılı olarak üretilir. / The tools have a built in 1.5° helix angle. / Стандартные опорные пластины имеют угол наклона 1.5°  
 UYARI / WARNING / ПРЕДУПРЕЖДЕНИЕ: Sayfa 130'deki B ve D figürleri uygulanamaz. / The operation for B and D on page 130 can not be applied. / Операции для B и D на стр. 130 не применяется

Sipariş Örneği/Ordering Example/Образец заказа

1 ad./pcs./шт. SER 0808 E11



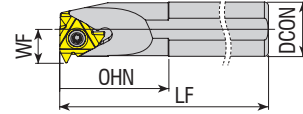
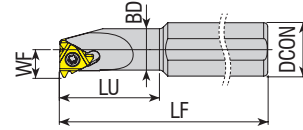
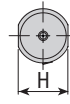
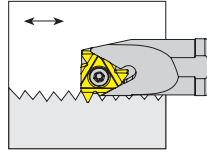

Yedek Parçaları / Spare Parts / Запасные части

Takım Kodu Ordering Code Код для заказа	Stok Stock Наличие		Takım Ölçüleri (mm) Dimension (mm) Размеры (мм)						Kesici Uç Insert Пластина	Sıkma Vidası Screw Зажимной винт	Altlık Shim Опорная пластина	Altlık Vidası Shim Screw Винт опорной пластины	Baskı Parçası Wedge Clamp Прижим	Baskı Vidası Clamp Screw Зажимной винт	Tork Anahtar Torx Key Торкс Ключ
	R	L	DCON	BD	LF	LU=OHN	WF	DMIN							
SIR/L S12X05H 06	●	○	12	05	100	15	4.3	6.4	06 IR/L	3006-M2X3.6	-	-	-	-	80-T06
SIR/L S16X05H 06	○	●	16	05	100	15	4.3	6.4	08 IR/L	3007-M2.2x5	-	-	-	-	80-T07
SIR/L S16X07M 08	●	●	16	07	150	18	5.3	7.8	11 IR/L	4008-M2.5x6	-	-	-	-	80-T08
SIR/L S10H 11	●	●	10	10	100	-	7.4	12	16 IR/L (0.35 - 3) ISO METRIC	4015-M3.5x9	-	-	-	-	80-T15
SIR/L S12K 11	●	●	12	12	125	-	8.4	16		4015-M3.5x11	-	-	-	-	
SIR/L S16X10M 11	●	●	16	10	150	25	7.4	12		-	-	-	-	-	
SIR/L S16X13M 11	●	●	16	13	150	32	8.9	15		-	-	-	-	-	
SIR/L S16M 11	●	●	16	16	150	-	11.7	19		-	-	-	-	-	
SIR/L S16X13M 16	●	●	16	13	150	32	10.2	16		-	-	-	-	-	
SIR/L S16M 16	●	●	16	16	150	-	11.7	19		-	-	-	-	-	
SIR/L S20X16P 16	●	●	20	16	170	40	11.7	19	4015-M3.5x14	AATN-2-0020	AAV-06-M3.5x11	ACK-05	4015-M4x11	80-T15	
SIR/L S20P 16	●	●	20	20	170	-	13.7	24	4020-M4.5x12	-	-	-	-	80-T15	
SIR/L S25R 16C	●	●	25	25	200	-	16.2	29	1020-M4.5x16	AATN-2-0004	AAV-07-M4.5x13	ACK-05	4015-M4x11	80-T20	
SIR/L S32S 16C	●	●	32	32	250	-	19.7	36	22 IR/L (3.5 - 4.5) ISO METRIC	-	-	-	-	80-T20	
SIR/L S40T 16C	●	●	40	40	300	-	23.7	44	16 IR/L (1.5-3 TR)	4015-M3.5x14	-	-	-	80-T15	
SIR/L S50U 16C	●	●	50	50	350	-	28.7	54	22 IR/L (4-6 TR)	1020-M4.5x16	-	-	-	80-T20	
SIR/L S20P 22	●	●	20	20	170	-	15.7	24	-	-	-	-	-	80-T15	
SIR/L S25R 22C	●	●	25	25	200	-	18.1	29	-	-	-	-	-	80-T20	
SIR/L S32S 22C	●	●	32	32	250	-	21.6	38	-	-	-	-	-	80-T20	
SIR/L S40T 22C	●	●	40	40	300	-	25.6	46	-	-	-	-	-	80-T20	
SIR/L S50U 22C	●	●	50	50	350	-	30.6	58	-	-	-	-	-	80-T20	
SIR/L S25R 16C-T	●	●	25	25	200	-	16.2	29	-	-	-	-	-	80-T15	
SIR/L S32S 16C-T	●	●	32	32	250	-	19.7	36	-	-	-	-	-	80-T15	
SIR/L S25R 22C-T	●	●	25	25	200	-	18.1	29	-	-	-	-	-	80-T20	
SIR/L S32S 22C-T	●	●	32	32	250	-	21.6	38	-	-	-	-	-	80-T20	

R: Sağ / Right / Правый L: Sol / Left / Левый ● Stokta / In Stock / В наличии ○ Stokta Yok / Non Stock Item / Нет в наличии  
Takımlar standart 1.5° helis açılı olarak üretilir. / The tools have a built in 1.5° helix angle. / Стандартные опорные пластины имеют угол наклона 1.5°  
UYARI / WARNING / ПРЕДУПРЕЖДЕНИЕ: Sayfa 131'deki B ve D figürleri uygulanamaz. / The operation for B and D on page 131 can not be applied. / Операции для B и D на стр. 131 не применяется

Sipariş Örneği/Ordering Example/Образец заказа  
1 ad./pcs./шт. SIR S12X05H 06

## DIŞ ÇAP DIŞ AÇMA KATERLERİ

### EXTERNAL THREADING TOOLHOLDERS

ДЕРЖАВКА ДЛЯ НАРЕЗАНИЯ НАРУЖНОЙ РЕЗЬБЫ С РЕГУЛИРОВКОЙ УГЛА НАКЛОНА РЕЖУЩЕЙ ПЛАСТИНЫ

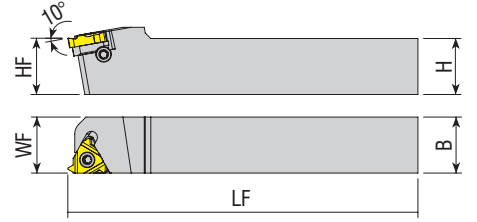
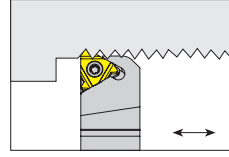
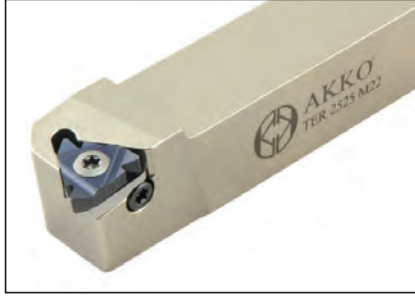

Takım Kodu Ordering Code Код для заказа	Stok Stock Наличие		Takım Ölçüleri (mm) Dimension (mm) Размеры (мм)				Kesici Uç Insert Пластина	Yedek Parçaları / Spare Parts / Запасные части					
	R	L	HF=H	B	LF	WF		Sıkma Vidası Screw Зажимной винт	Sağ Altlık Right Shim U-Platte für WSP rechts	Sol Altlık Left Shim U-Platte für WSP links	Altlık Vidası Shim Screw Винт опорной пластины	Altlık Vidası Pulu Shim Screw Ring Винт опорной пластины/пульт	Tork Anahtar Torx Key Торх Ключ
TER/L 1616 H16	●	●	16	16	100	16	16 ER/EL	1710-U5-40x12.2	ATS-16E	ATS-16I	AAV-11-U5-40x4.5	ABPL-03	80-T10
TER/L 2020 K16	●	●	20	20	125	20							
TER/L 2525 M16	●	●	25	25	150	25							
TER/L 3232 P16	●	●	32	32	170	32							
TER/L 2525 M22	●	●	25	25	150	25	22 ER/EL	1720-U8-32x15	ATS-22E	ATS-22I	AAV-12-U8-32x5.5	ABPL-04	80-T20
TER/L 3232 P22	●	●	32	32	170	32							
TER/L 4040 S22	●	●	40	40	250	40							
TER/L 2525 M27	●	●	25	25	150	25	27 ER/EL	1620-M5x22	ATS-27E	ATS-27I	AAV-15-M5x5.7	ABPL-05	80-T20
TER/L 3232 P27	●	●	32	32	170	32							
TER/L 4040 S27	●	●	40	40	250	40							

R: Sağ / Right / Правый L: Sol / Left / Левый ● Stokta / In Stock / В наличии ○ Stokta Yok / Non Stock Item / Нет в наличии

Sipariş Örneği/Ordering Example/Образец заказа

Takımlar standart 1.5° helis açılı olarak üretilir. / The tools have a built in 1.5° helix angle. / Стандартные опорные пластины имеют угол наклона 1.5°

1 ad./pcs./шт. TER 1616 H16

### DIŞ ÇAP SAĞ YÖNDE VİDA AÇMA EXTERNAL RIGHT HAND THREADING OPERATION НАРЕЗАНИЕ ПРАВОЙ НАРУЖНОЙ РЕЗЬБЫ

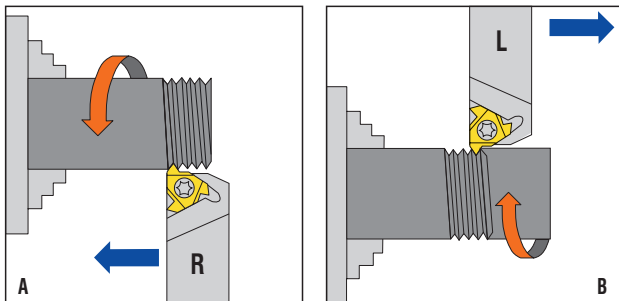

### DIŞ ÇAP SOL YÖNDE VİDA AÇMA EXTERNAL LEFT HAND THREADING OPERATION НАРЕЗАНИЕ ЛЕВОЙ НАРУЖНОЙ РЕЗЬБЫ

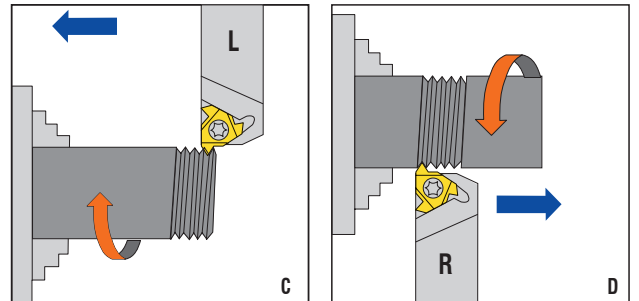

#### UYARI / WARNING / ВНИМАНИЕ

Figür B ve D için; negatif açılı altlık kullanılmalıdır. / For figure B and D; negative shim must be used. / Для схем B и D необходимо использовать отрицательную подложку под резьбовую пластину.  
Altiksız katerlerde B ve D figürü uygulanamaz. / B and D figures can not be applied on tools without shim. / Схемы B и D нельзя применять без подкладки под резьбовую пластину.



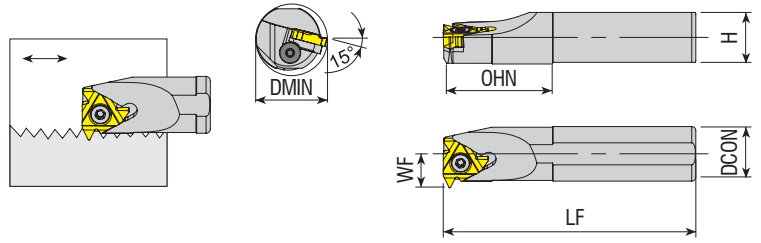

Takım Kodu Ordering Code Код для заказа	Stok Stock Наличие		Takım Ölçüleri (mm) Dimension (mm) Размеры (мм)						Kesici Uç Insert Пластина	Yedek Parçaları / Spare Parts / Запасные части					
	R	L	DCON	WF	LF	OHN	WF	DMIN		Sıkma Vidası Screw Зажимной винт	Sol Altlık Left Shim Ц-Пластина for WSP tools	Sağ Altlık Right Shim Ц-Пластина for WSP tools	Altlık Vidası Shim Screw Винт опорной пластины	Altlık Vidası Pulu Shim Screw Ring Винт опорной пластины/пруг	Tork Anahtar Torx Key Торх Ключ
TIR/L S25R 16	●	●	25	25	200	-	16.2	29	16 IR/L	1710-U5-40x12.2	ATS-16E	ATS-16I	AAV-11-U5-40x4.5	ABPL-03	80-T10
TIR/L S32S 16	●	●	32	32	250	-	19.7	36							
TIR/L S40T 16	●	●	40	40	300	-	23.7	44							
TIR/L S50U 16	●	●	50	50	350	-	28.7	54							
TIR/L S25R 22	●	●	25	25	200	-	18.1	29	22 IR/L	1720-U8-32x15	ATS-22E	ATS-22I	AAV-12-U8-32x5.5	ABPL-04	80-T20
TIR/L S32S 22	●	●	32	32	250	-	21.6	38							
TIR/L S40T 22	●	●	40	40	300	-	25.6	46							
TIR/L S50U 22	●	●	50	50	350	-	30.6	58							
TIR/L S32S 27	●	●	32	32	250	-	22.6	40	27 IR/L	1620-M5x18	ATS-27E	ATS-27I	AAV-15-M5x5.7	ABPL-05	80-T20
TIR/L S40T 27	●	●	40	40	300	-	26.6	48		1620-M5x22					
TIR/L S50U 27	●	●	50	50	350	-	31.6	58							
TIR/L A25R 16	○	●	25	25	200	50	16.2	29	16 IR/L	1710-U5-40x12.2	ATS-16E	ATS-16I	AAV-11-U5-40x4.5	ABPL-03	80-T10
TIR/L A32S 16	○	●	32	32	250	60	19.7	36							
TIR/L A40T 16	○	●	40	40	300	65	23.9	44							

R: Sağ / Right / Правый L: Sol / Left / Левый ● Stokta / In Stock / В наличии ○ Stokta Yok / Non Stock Item / Нет в наличии  
Takımlar standart 1.5° helis açılı olarak üretilir. / The tools have a built in 1.5° helix angle. / Стандартные опорные пластины имеют угол наклона 1.5°

Sipariş Örneği/Ordering Example/Образец заказа  
1 ad./pcs./шт. TIR S25R 16

DELİK İÇİ SAĞ YÖNDE VİDA AÇMA  
INTERNAL RIGHT HAND THREADING OPERATION  
НАРЕЗАНИЕ ПРАВОЙ НАРУЖНОЙ РЕЗЬБЫ

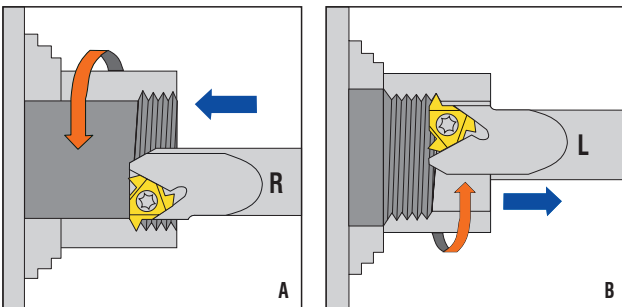

DELİK İÇİ SOL YÖNDE VİDA AÇMA  
INTERNAL LEFT HAND THREADING OPERATION  
НАРЕЗАНИЕ ЛЕВОЙ НАРУЖНОЙ РЕЗЬБЫ

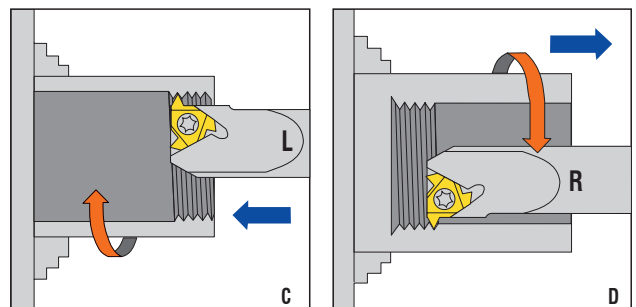

UYARI / WARNING / ВНИМАНИЕ

Figür B ve D için; negatif açılı altlık kullanılmalıdır. / For figure B and D; negative shim must be used. / Für Abbildung B und D; negative Unterlage verwenden.  
Altıksız katerlerde B ve D figürü uygulanamaz. / B and D figures can not be applied on tools without shim. / Схемы B и D нельзя применять без подкладки под резьбовую пластину



## Diş Helis Açısı Thread Helix Angle Угол подъема резьбы

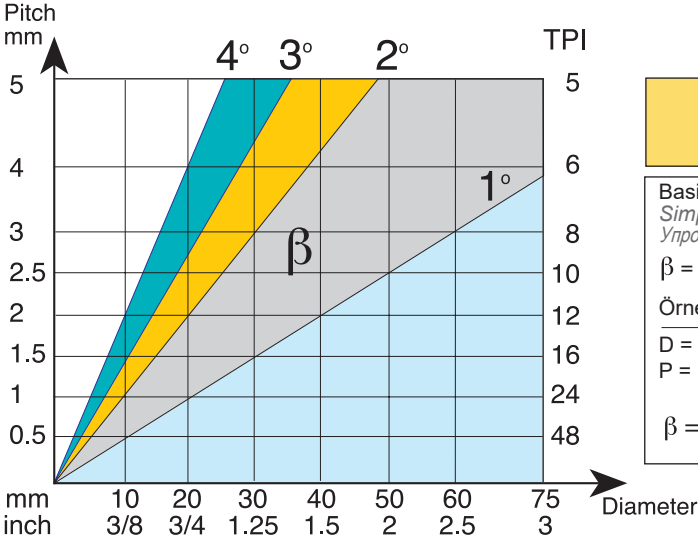

$$\tan \beta = \frac{P}{\pi \times D}$$

Basitleştirilmiş formül  
 Simplified formula  
 Упрощенная формула

$$\beta = 20 P/D$$

Örnek / Example / Пример:

$$D = 25 \text{ mm (0.98")}$$

$$P = 1.5 \text{ mm (16 TPI)}$$

$$\beta = \frac{25 \times 1.5}{40} = 1.25^\circ$$

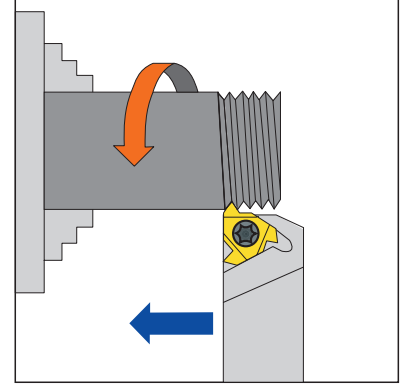

## Standart ve Eğik Altlıklar Standard and Slanted Shim

Стандартная и наклонная опорная пластина

Akko diş açma takımlarının, uç yuvaları 1.5° helis açılı olarak üretilir. Farklı helis açılı diş açmak isteyenler altlığı değiştirerek istedikleri dereceyi elde edebilirler.

Negatif helis genellikle sol katerde sağ diş çekmek için kullanılır ya da sağ katerde sol diş çekmek için kullanılır.

Akko Toolholders Pockets have a built in 1.5° helix angle. This angle may be adjusted to better match the thread helix angle by simply changing the shim.

Negative helix is usually used when threading RH thread with LH Holder or LH thread with RH Holder.

Державки АККО имеют стандартный угол наклона опорной пластины 1,5°. Этот угол можно отрегулировать путем замены опорной пластины. Отрицательный угол наклона обычно используется когда правая резьба RH нарезается левой державкой LH или левая резьба LH нарезается правой державкой RH.

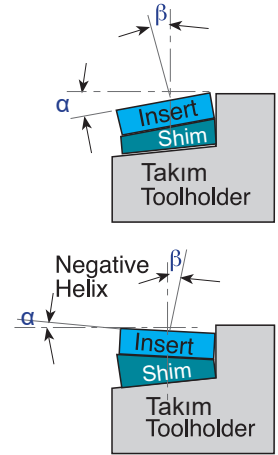

L	IC	Takım Tipi Tool Type Тип Инструмента	Uç Yuvasının Açısı (α) / Pocket's Angle (α) / Угол наклона (α)						
			4.5°	3.5°	2.5°	1.5°	0.5°	-0.5°	-1.5°
16	3/8	EX-RH or IN-LH	ATS-16E+4.5	ATS-16E+3.5	ATS-16E+2.5	ATS-16E	ATS-16E+0.5	ATS-16E-0.5	ATS-16E-1.5
16	3/8	EX-LH or IN-RH	ATS-16I+4.5	ATS-16I+3.5	ATS-16I+2.5	ATS-16I	ATS-16I+0.5	ATS-16I-0.5	ATS-16I-1.5
22	1/2	EX-RH or IN-LH	ATS-22E+4.5	ATS-22E+3.5	ATS-22E+2.5	ATS-22E	ATS-22E+0.5	ATS-22E-0.5	ATS-22E-1.5
22	1/2	EX-LH or IN-RH	ATS-22I+4.5	ATS-22I+3.5	ATS-22I+2.5	ATS-22I	ATS-22I+0.5	ATS-22I-0.5	ATS-22I-1.5
27	5/8	EX-RH or IN-LH	ATS-27E+4.5	ATS-27E+3.5	ATS-27E+2.5	ATS-27E	ATS-27E+0.5	ATS-27E-0.5	ATS-27E-1.5
27	5/8	EX-LH or IN-RH	ATS-27I+4.5	ATS-27I+3.5	ATS-27I+2.5	ATS-27I	ATS-27I+0.5	ATS-27I-0.5	ATS-27I-1.5

## Altlık Değişirme Öneri Tablosu / Shim Change Recommendation Рекомендации по смене опорной пластины

Tabloda da görüldüğü gibi bazı diş hatvelerinin çaplara göre kombinasyonları altlık değişimini gerektirir. Eğer değişim gerekli ise EX-RH ve IN-LH katerleri için ATS-E altlıklarını, IN-RH ve EX-LH katerleri için ATS-I altlıklarını kullanın.

As can be seen from the chart, some Pitch to Diameter combinations require a shim change. If change is required, use ATS-E shim for EX-RH and IN-LH toolholders and ATS-I shims for IN-RH and EX-LH toolholders.

Как видно из диаграммы, некоторые комбинации Шаг на Диаметр требуют замены опорной пластины. Если требуется замена, используйте опорные пластины ATS-E для державок инструментов EX-RH и IN-LH и опорные пластины ATS-I для державок IN-RH и EX-LH.

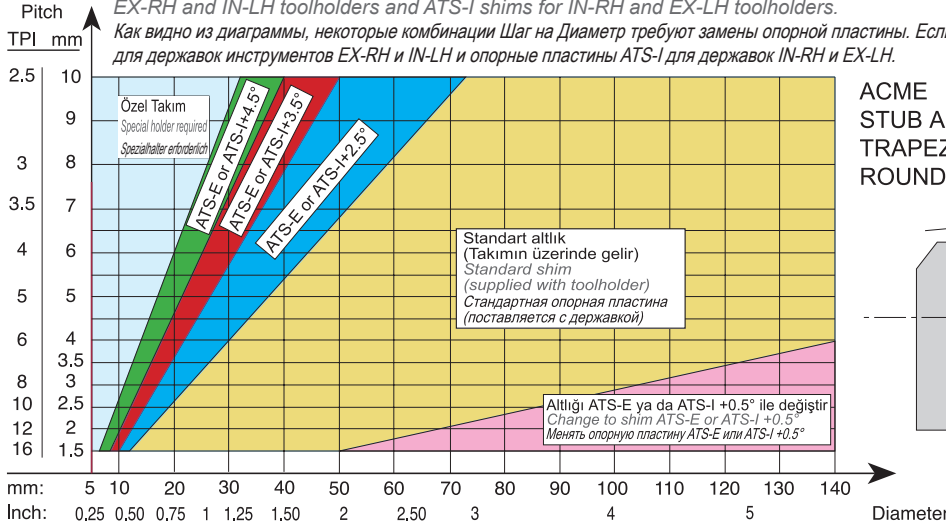

ACME  
 STUB ACME  
 TRAPEZ (DIN 103)  
 ROUND (DIN 405)

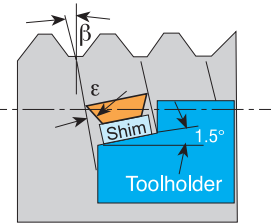

Tabloda da görüldüğü gibi çoğu uygulamalar altlık değişimine ihtiyaç duymaz. Eğer değişime ihtiyaç duyulursa EX-RH ve IN-LH katerleri için ATS-E altlıklarını, IN-RH ve EX-LH katerleri için ATS-I altlıklarını kullanın.

As can be seen from the chart, most applications do not require a shim change. If change is required, use ATS-E shims for EX-RH and IN-LH toolholders and ATS-I shims for IN-RH and EX-LH toolholders.

Как видно из диаграммы, некоторые комбинации Шаг на Диаметр требуют замены опорной пластины. Если требуется замена, используйте опорные пластины ATS-E для державок инструментов EX-RH и IN-LH и опорные пластины ATS-I для державок IN-RH и EX-LH.

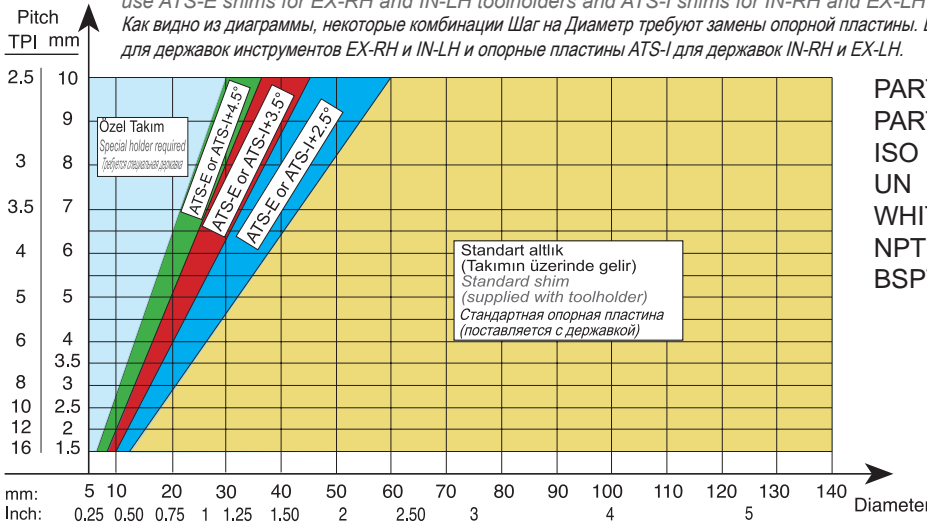

PARTIAL PROFILES 60°  
 PARTIAL PROFILES 55°  
 ISO  
 UN  
 WHIT.  
 NPT  
 BSPT

Tabloda da görüldüğü gibi çoğu uygulamalar altlık değişimine ihtiyaç duyar. Çoğu durumda negatif bir altlığa ihtiyaç duyulur. EX-RH ve IN-LH takımlar için ATS-E altlıklarını kullanın. IN-RH ve EX-LH takımlar için ATS-I altlıklarını kullanın.

As can be seen from the chart, most applications require a shim change. In most cases a negative shim is required, use ATS-E shims for EX-RH and IN-LH toolholders. ATS-I shims for IN-RH and EX-LH toolholders.

Как видно из диаграммы, в большинстве случаев требуется смена опорной пластины. В основном применяется отрицательная опорная пластина, используйте опорные пластины ATS-E для державок EX-RH и IN-LH. Опорные пластины ATS-I для державок IN-RH и EX-LH.

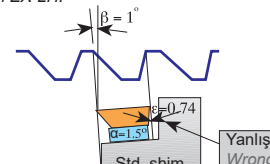
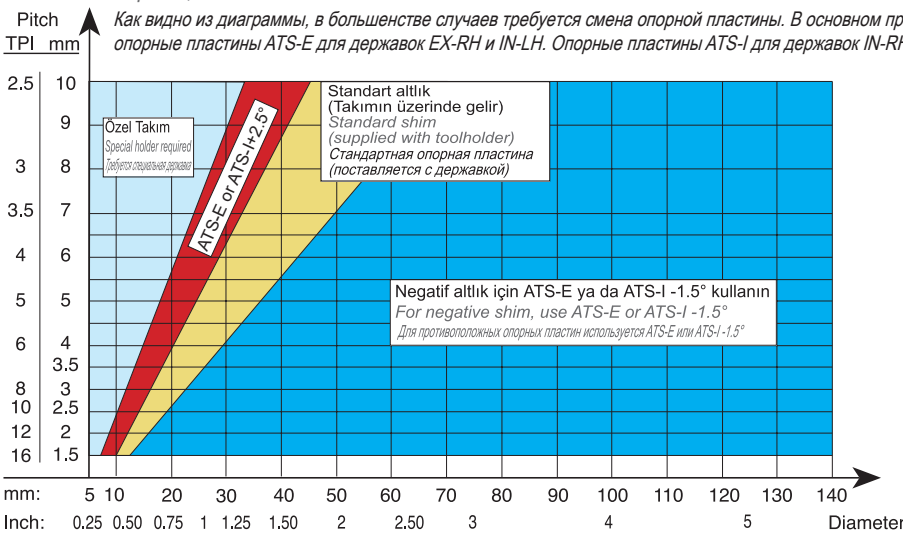

Before Shim Change  
 Altlığı Değiştirmeden Önce  
 До смены опорной пластины

AMERICAN  
 BUTTRESS  
 SAGENGWINDE  
 (DIN 513)

Standart altlığın negatif bir altlıkla değiştirilmesi, kenar sürtmesini engelleyecektir.

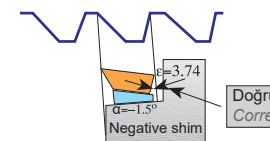

After Shim Change  
 Altlığı Değiştirdikten Sonra  
 После смены опорной пластины

Replacing the standard shim with a shim has negative angle, will eliminate side rubbing  
 Смена стандартной опорной пластины на пластину с отрицательным углом устраняет боковое трение



*konusulan*  
**the spoken** *kalite...*  
*quality...*

# KANAL AÇMA

KANAL AÇMA TAKIMLARI  
GROOVING TOOLHOLDERS  
ДЕРЖАВКИ ДЛЯ ОБРАБОТКИ КАНАВOK





AKKO **A** **AKT** - **K** - **R** - **2525**

1 2 3 4 5

**100** - **150** - **4** - **T22**

6 7 8

**2** Kesici Stili / *Cutter Style* / Тип режущего инструмента

DKT: Dış Çap Kanal Açma Takımı / *External Grooving Toolholders*  
ДЕРЖАВКИ ДЛЯ ОБРАБОТКИ НАРУЖНЫХ КАНАВОК  
IKT: Delik İçi Kanal Açma Takımı / *Internal Grooving Toolholders*  
ДЕРЖАВКИ ДЛЯ ОБРАБОТКИ ВНУТРЕННИХ КАНАВОК  
AKT: Dış Çap Alın Kanal Takımları / *Face Grooving Toolholders*  
ДЕРЖАВКА ДЛЯ ОБРАБОТКИ ТОРЦЕВЫХ КАНАВОК  
LKT: L Tip Alın Kanal Açma Takımı / *L Type Face Grooving Toolholders*  
ДЕРЖАВКА L-ТИПА ДЛЯ ОБРАБОТКИ ТОРЦЕВЫХ КАНАВОК

**3** Uç Tipi / *Insert Type* / Форма пластины

KRLY / MGM.  
HRN / S312, S229, S224, S223  
ISCR / DGN, GI, GTN  
SNDVK / 123, 151, 154.91  
ZCC  
KM / A4.  
ARN / LOMR.  
TGTC / TD.

**4** Kesme Yönü / *Cutting Direction*  
Направление резания

R L

**5** Kesme Kenar Yüksekliği ve Şaft Genişliği  
*Cutting Edge Height and Shank Width*  
Высота и Ширина державки

H  
B  
DCON

**6** Kesme Aralığı  
*Cutting Diameter*  
Диаметр Резания

DAXX (150)  
DAXIN (100)

**7** Kesme Kenar Genişliği / *Cutting Width Edge*  
Ширина режущей кромки

ÖR/E.G :  
2 = 2.0 mm  
3 = 3.0 mm  
4 = 4.0 mm  
5 = 5.0 mm  
6 = 6.0 mm  
8 = 8.0 mm

CW

**8** Kesme Derinliği / *Cutting Depth* / Глубина резания

CDX  
CDX

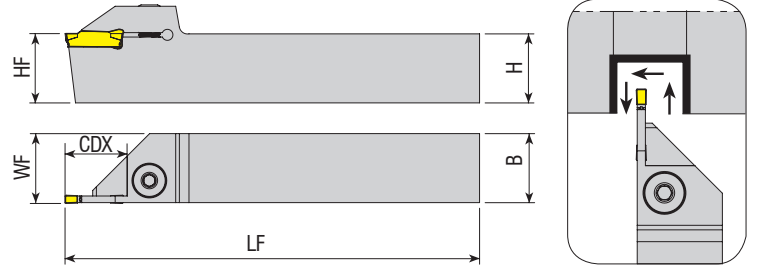

Takım Kodu Ordering Code Код для заказа	Stok Stock Наличие		Takım Ölçüleri (mm) Dimension (mm) Размеры (мм)					Kesici Uç Insert Пластина	Yedek Parçaları / Spare Parts / Запасные части		
	R	L	HF=H	B	LF	WF	CDX		Sıkma Vidası Screw Зажимной винт	Pul Stamp Шайба	Anahtar Allen Key Ключ
ADKT-K-R/L-1212-1.5-T15	●	●	12	12	100	12.2	15	MGM. - 1.5	AKV-02-M6x22	ABPL-01	AAL-03-3
ADKT-K-R/L-2020-1.5-T15	●	●	20	20	125	20.2	15				
ADKT-K-R/L-1212-2-T15	●	●	12	12	100	16.3	15	MGM. - 2	AKV-02-M6x22	ABPL-01	AAL-03-3
ADKT-K-R/L-1616-2-T10	●	●	16	16	125	16.3	10				
ADKT-K-R/L-1616-2-T15	●	●	16	16	125	16.3	15				
ADKT-K-R/L-2020-2-T15	●	●	20	20	150	20.3	15				
ADKT-K-R/L-2525-2-T15	●	●	25	25	150	25.3	15				
ADKT-K-R/L-3232-2-T15	●	●	32	32	170	32.3	15				
ADKT-K-R/L-1212-3-T15	●	●	12	12	100	12.3	15	MGM. - 3			
ADKT-K-R/L-1616-3-T15	●	●	16	16	125	16.3	15				
ADKT-K-R/L-2020-3-T10	●	●	20	20	125	20.3	10				
ADKT-K-R/L-2020-3-T20	●	●	20	20	125	20.3	20				
ADKT-K-R/L-2020-3-R28	●	●	20	20	125	20.3	28				
ADKT-K-R/L-2525-3-T10	●	●	25	25	150	25.3	10				
ADKT-K-R/L-2525-3-R15	●	●	25	25	150	25.3	15				
ADKT-K-R/L-2525-3-T22	●	●	25	25	150	25.3	22				
ADKT-K-R/L-3232-3-T10	●	●	32	32	170	32.3	10				
ADKT-K-R/L-3232-3-T22	●	●	32	32	170	32.3	22				
ADKT-K-R/L-2020-4-T10	●	●	20	20	125	20.4	10	MGM. - 4	2004-M8x1x20	-	AAL-05-4
ADKT-K-R/L-2020-4-T20	●	●	20	20	125	20.4	20				
ADKT-K-R/L-2020-4-R25	●	○	20	20	125	20.4	25				
ADKT-K-R/L-2525-4-T10	●	●	25	25	150	25.4	10				
ADKT-K-R/L-2525-4-T18	●	●	25	25	150	25.4	18				
ADKT-K-R/L-2525-4-T22	●	●	25	25	150	25.4	22				
ADKT-K-R/L-3232-4-T10	●	●	32	32	170	32.4	10	MGM. - 5			
ADKT-K-R/L-3232-4-T22	●	●	32	32	170	32.4	22				
ADKT-K-R/L-2020-5-T20	●	●	20	20	125	20.5	20				
ADKT-K-R/L-2525-5-T15	●	●	25	25	150	25.5	15				
ADKT-K-R/L-2525-5-T18	●	●	25	25	150	25.5	18				
ADKT-K-R/L-2525-5-T25	●	●	25	25	150	25.5	25				
ADKT-K-R/L-3232-5-T15	●	●	32	32	170	32.5	15	MGM. - 6			
ADKT-K-R/L-3232-5-T25	●	●	32	32	170	32.5	25				
ADKT-K-R/L-2525-6-T15	●	●	25	25	150	25.6	15				
ADKT-K-R/L-2525-6-T25	●	●	25	25	150	25.6	25	MGM. - 8			
ADKT-K-R/L-3232-6-T25	●	●	32	32	170	32.6	25				
ADKT-K-R/L-3232-8-T32	●	●	32	32	170	32.8	32				

R: Sağ / Right / Правый L: Sol / Left / Левый

● Stokta / In Stock / В наличии ○ Stokta Yok / Non Stock Item / Нет в наличии

KRLY - JD Ucuna Uygun / Compatible with KRLY - JD Insert. / Под пластину KRLY - JD

Sipariş Örneği/Ordering Example/Образец заказа

1 ad./pcs./шт. ADKT-K-R-1212-1.5-T15

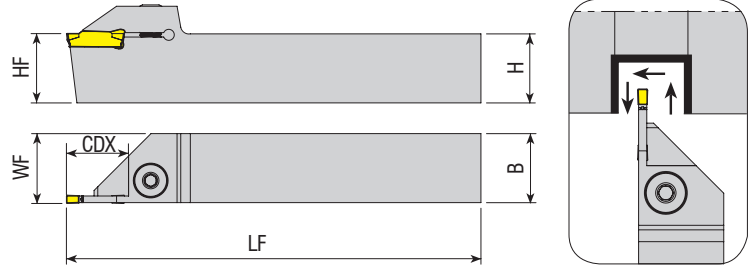
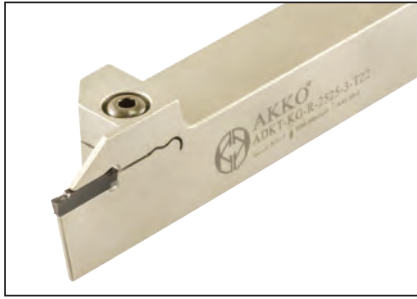

Takım Kodu Ordering Code Код для заказа	Stok Stock Наличие		Takım Ölçüleri (mm) Dimension (mm) Размеры (мм)					Kesici Uç Insert Пластина	Yedek Parçaları / Spare Parts / Запасные части		
	R	L	HF=H	B	LF	WF	CDX		Sıkma Vidası Screw Зажимной винт	Pul Stamp Шайба	Anahtar Allen Key Ключ
ADKT-KG-R/L-2020-2-T15	●	●	20	20	125	20.2	15	KG.. - 2	AKV-02-M6x22	ABPL-01	AAL-03-3
ADKT-KG-R/L-2525-2-T8	●	●	25	25	150	25.2	8				
ADKT-KG-R/L-2525-2-T15	●	○	25	25	150	25.2	15				
ADKT-KG-R/L-2525-2-T17	●	○	25	25	150	25.2	17	KG.. - 3	2004-M8x1x20	-	AAL-05-4
ADKT-KG-R/L-1616-3-T20	●	●	16	16	125	16.3	20				
ADKT-KG-R/L-2020-3-T20	●	●	20	20	125	20.3	20				
ADKT-KG-R/L-2525-3-T10	●	●	25	25	150	25.3	10				
ADKT-KG-R/L-2525-3-T13	●	●	25	25	150	25.3	13				
ADKT-KG-R/L-2525-3-T22	●	●	25	25	150	25.3	22				
ADKT-KG-R/L-2020-4-T20	●	●	20	20	125	20.4	20	KG.. - 4	2004-M8x1x20	-	AAL-05-4
ADKT-KG-R/L-2525-4-T10	●	●	25	25	150	25.4	10				
ADKT-KG-R/L-2525-4-T16	●	○	25	25	150	25.4	16				
ADKT-KG-R/L-2525-4-T22	●	○	25	25	150	25.4	22				
ADKT-KG-R/L-2525-5-T12	●	●	25	25	150	25.5	12	KG.. - 5	2004-M8x1x20	-	AAL-05-4
ADKT-KG-R/L-2525-5-T15	●	●	25	25	150	25.5	15				
ADKT-KG-R/L-2525-5-T25	●	○	25	25	150	25.5	25				
ADKT-KG-R/L-2525-6-T25	○	○	25	25	150	25.6	25	KG.. - 6	2004-M8x1x20	-	AAL-05-4

R: Sağ / Right / Правый L: Sol / Left / Левый  
● Stokta / In Stock / В наличии ○ Stokta Yok / Non Stock Item / Нет в наличии  
KRLY Ucuna Uygunudur. / Compatible with KRLY Insert. / Под пластину KRLY

Sipariş Örneği/Ordering Example/Образец заказа  
1 ad./pcs./шт. ADKT-KG-R-2020-2-T15



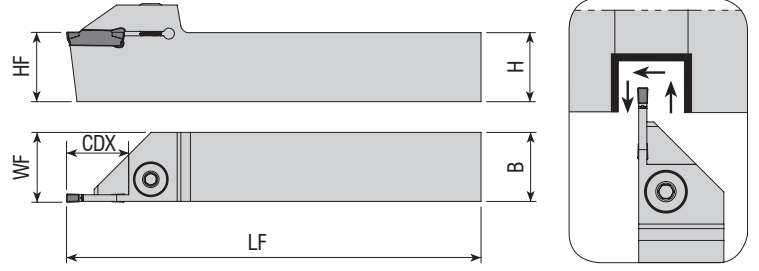

Takım Kodu Ordering Code Код для заказа	Stok Stock Наличие		Takım Ölçüleri (mm) Dimension (mm) Размеры (мм)				Kesici Uç Insert Пластина	Yedek Parçaları / Spare Parts / Запасные части			
	R	L	HF=H	B	LF	WF		CDX	Sıkma Vidası Screw Зажимной винт	Pul Stamp Шайба	Anahtar Allen Key Ключ
ADKT-SGC-R/L-1212-2-R15	●	●	12	12	100	16.2	15	GCM N20	AKV-02-M6x22	ABPL-01	AAL-03-3
ADKT-SGC-R/L-1616-2-R15	●	●	16	16	125	16.2	15				
ADKT-SGC-R/L-2020-2-R20	●	●	20	20	125	20.2	20				
ADKT-SGC-R/L-2525-2-R20	●	●	25	25	150	25.2	20				
ADKT-SGC-R/L-1212-3-R15	●	●	12	12	100	16.3	15	GCM N30	2004-M8x1x20	-	AAL-05-4
ADKT-SGC-R/L-1616-3-R15	●	●	16	16	125	16.3	15				
ADKT-SGC-R/L-2020-3-R22	●	●	20	20	125	20.3	22				
ADKT-SGC-R/L-2525-3-R15	●	○	25	25	150	25.3	15				
ADKT-SGC-R/L-2525-3-R22	●	●	25	25	150	25.3	22				
ADKT-SGC-R/L-2525-4-R25	●	○	25	25	150	25.4	25	GCM N40			

SMTM Ucuna Uygundur. / Compatible with SMTM Insert. / Под пластину SMTM

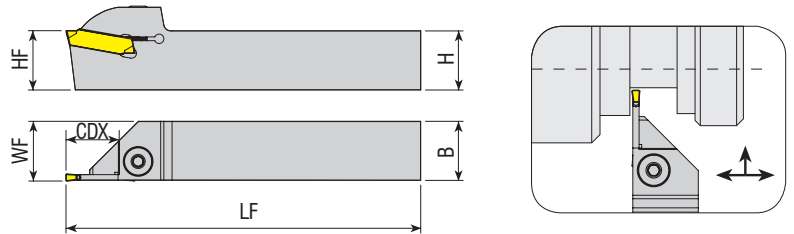

Takım Kodu Ordering Code Код для заказа	Stok Stock Наличие		Takım Ölçüleri (mm) Dimension (mm) Размеры (мм)				Kesici Uç Insert Пластина	Yedek Parçaları / Spare Parts / Запасные части			
	R	L	HF=H	B	LF	WF		CDX	Sıkma Vidası Screw Зажимной винт	Pul Stamp Шайба	Anahtar Allen Key Ключ
ADKT-H-R/L-2020-3-T20	●	●	20	20	125	20.5	20	S229 - 3			
ADKT-H-R/L-2525-3-T22	●	●	25	25	150	25.5	22				
ADKT-H-R/L-2525-3-T26	●	●	25	25	150	25.5	26				
ADKT-H-R/L-2020-4-T20	●	●	20	20	125	20.5	20	S229 - 4	2004-M8x1x20	-	AAL-05-4
ADKT-H-R/L-2525-4-T22	●	●	25	25	150	25.5	22				
ADKT-H-R/L-3232-4-T22	●	●	32	32	170	32.5	22				
ADKT-H-R/L-2020-5-T20	●	●	20	20	125	20.5	20				
ADKT-H-R/L-2525-5-T25	●	●	25	25	150	25.5	25	S229 - 5			
ADKT-H-R/L-2525-6-T25	●	●	25	25	150	25.6	25	S229 - 6			

R: Sağ / Right / Правый L: Sol / Left / Левый  
● Stokta / In Stock / В наличии ○ Stokta Yok / Non Stock Item / Нет в наличии  
HRN Ucuna Uygundur. / Compatible with HRN Insert. / Под пластину HRN

Sipariş Örneği/Ordering Example/Образец заказа  
1 ad./pcs./шт. ADKT-SGC-R-1212-2-R15

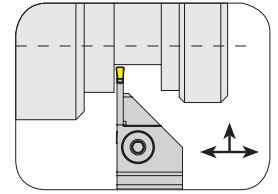
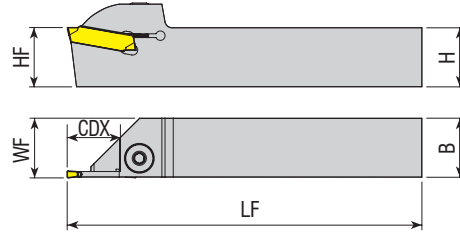
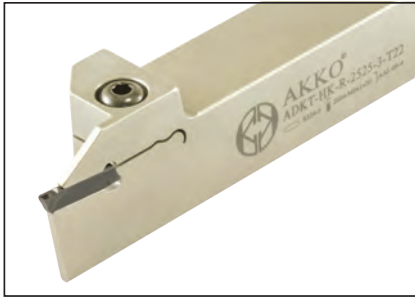

Takım Kodu Ordering Code Код для заказа	Stok Stock Наличие		Takım Ölçüleri (mm) Dimension (mm) Размеры (мм)				Kesici Uç Insert Пластина	Yedek Parçaları / Spare Parts / Запасные части			
	R	L	HF=H	B	LF	WF		CDX	Sıkma Vidası Screw Зажимной винт	Pul Stamp Шайба	Anahtar Allen Key Ключ
ADKT-HK-R/L-1616-2-T15	●	●	16	16	125	16.3	15	S224 - 2	AKV-02-M6x22	ABPL-01	AAL-03-3
ADKT-HK-R/L-2020-2-T15	●	●	20	20	125	20.3	15				
ADKT-HK-R/L-2525-2-T15	●	●	25	25	150	25.3	15				
ADKT-HK-R/L-1616-3-T15	○	○	16	16	125	16.3	15	S224 - 3	2004-M8x1x20	-	AAL-05-4
ADKT-HK-R/L-2020-3-T20	●	●	20	20	125	20.4	20				
ADKT-HK-R/L-2525-3-T22	●	●	25	25	150	25.4	22				
ADKT-HK-R/L-2020-4-T20	●	●	20	20	125	20.4	20				
ADKT-HK-R/L-2525-4-T22	●	●	25	25	150	25.4	22	S224 - 4	2004-M8x1x20	-	AAL-05-4
ADKT-HS223-R/L-2020-2-T15	●	○	20	20	125	20.4	15				
ADKT-HS223-R/L-2020-3-T17	●	○	20	20	125	20.3	17	S223 - 3	2004-M8x1x20	-	AAL-05-4

HRN Ucuna Uygundur. / Compatible with HRN Insert. / Под пластину HRN

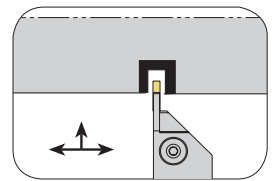
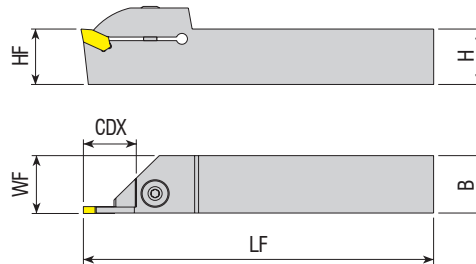

Takım Kodu Ordering Code Код для заказа	Stok Stock Наличие		Takım Ölçüleri (mm) Dimension (mm) Размеры (мм)				Kesici Uç Insert Пластина	Yedek Parçaları / Spare Parts / Запасные части			
	R	L	HF=H	B	LF	WF		CDX	Sıkma Vidası Screw Зажимной винт	Pul Stamp Шайба	Anahtar Allen Key Ключ
ADKT-ZCC1-R/L-2020-3-T20	●	○	20	20	125	20.3	20	ZQMX - 3	2004-M8x1x20	-	AAL-05-4
ADKT-ZCC1-R/L-2525-3-T22	●	○	25	25	150	25.3	22				
ADKT-ZCC1-R/L-2020-4-T20	●	○	20	20	125	20.4	20	ZQMX - 4	2004-M8x1x20	-	AAL-05-4
ADKT-ZCC1-R/L-2525-4-T22	●	○	25	25	150	25.4	22				

R: Sağ / Right / Правый L: Sol / Left / Левый

● Stokta / In Stock / В наличии ○ Stokta Yok / Non Stock Item / Нет в наличии  
ZCC Ucuna Uygundur. / Compatible with ZCC Insert. / Под пластину ZCC.

Sipariş Örneği/Ordering Example/Образец заказа  
1 ad./pcs./шт. ADKT-HK-R-1616-2-T15



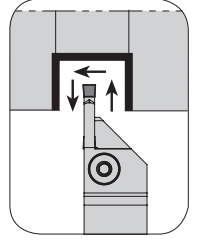
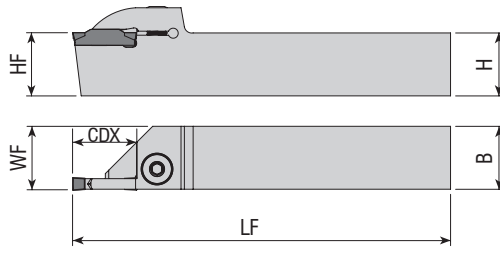

Takım Kodu Ordering Code Код для заказа	Stok Stock Наличие		Takım Ölçüleri (mm) Dimension (mm) Размеры (мм)					Kesici Uç Insert Пластина	Yedek Parçaları / Spare Parts / Запасные части			
	R	L	HF=H	B	LF	WF	CDX		Sıkma Vidası Screw Зажимной винт	Pul Stamp Шайба	Anahtar Allen Key Ключ	
ADKT-ZCC2-R/L-1616-2-T15	●	●	16	16	125	16.2	15	Z.BD - 2	AKV-02-M6x22	ABPL-01	AAL-03-3	
ADKT-ZCC2-R/L-2020-2-T7	●	●	20	20	125	20.2	7					
ADKT-ZCC2-R/L-2020-2-T15	●	●	20	20	125	20.2	15					
ADKT-ZCC2-R/L-2525-2-T15	●	●	25	25	150	25.2	15	Z.ED - 2.5				
ADKT-ZCC2-R/L-1616-2.5-T15	●	●	16	16	125	16.3	15					
ADKT-ZCC2-R/L-2020-2.5-T17	●	●	20	20	125	20.3	17					
ADKT-ZCC2-R/L-2525-2.5-T15	●	●	25	25	150	25.3	15	Z.FD - 3				
ADKT-ZCC2-R/L-1616-3-T15	●	●	16	16	125	16.3	15					
ADKT-ZCC2-R/L-1616-3-T17	●	○	16	16	125	16.3	17					
ADKT-ZCC2-R/L-1616-3-T20	●	○	16	16	125	16.3	20	Z.GD - 4	2004-M8x1x20	-	AAL-05-4	
ADKT-ZCC2-R/L-2020-3-T12	●	●	20	20	125	20.3	12					
ADKT-ZCC2-R/L-2020-3-T20	●	●	20	20	125	20.3	20					
ADKT-ZCC2-R/L-2020-3-R21	●	○	20	20	125	20.3	21	Z.HD - 5				
ADKT-ZCC2-R/L-2020-3-R25	●	●	20	20	125	20.3	25					
ADKT-ZCC2-R/L-2525-3-T12	●	○	25	25	150	25.3	12					
ADKT-ZCC2-R/L-2525-3-T22	●	●	25	25	150	25.3	22	Z.KD - 6				
ADKT-ZCC2-R/L-2525-3-R30	●	●	25	25	150	25.3	30					
ADKT-ZCC2-R/L-2020-4-T12	●	○	20	20	125	20.5	12					
ADKT-ZCC2-R/L-2020-4-T20	●	●	20	20	125	20.5	20	Z.HD - 5				
ADKT-ZCC2-R/L-2525-4-T12	●	●	25	25	150	25.5	12					
ADKT-ZCC2-R/L-2525-4-T22	●	●	25	25	150	25.5	22					
ADKT-ZCC2-R/L-2020-5-T12	●	○	20	20	125	20.5	12	Z.HD - 5				
ADKT-ZCC2-R/L-2020-5-T20	●	●	20	20	125	20.5	20					
ADKT-ZCC2-R/L-2525-5-T12	●	○	25	25	150	25.5	12					
ADKT-ZCC2-R/L-2525-5-T25	●	●	25	25	150	25.5	25	Z.KD - 6				
ADKT-ZCC2-R/L-3232-5-T25	●	●	32	32	170	32.5	25					
ADKT-ZCC2-R/L-2020-6-T20	●	●	20	20	125	20.6	20					
ADKT-ZCC2-R/L-2525-6-T25	●	●	25	25	150	25.6	25	Z.KD - 6				
ADKT-ZCC2-R/L-3232-6-T25	●	●	32	32	170	32.6	25					
ADKT-ZCC2-R/L-3232-6-T30	●	●	32	32	170	32.6	30					

R: Sağ / Right / Правый L: Sol / Left / Левый  
● Stokta / In Stock / В наличии ○ Stokta Yok / Non Stock Item / Нет в наличии  
ZCC Ucuna Uygunudur. / Compatible with ZCC Insert. / Под пластину ZCC

Sipariş Örneği/Ordering Example/Образец заказа  
1 ad./pcs./шт. ADKT-ZCC2-R-1616-2-T15

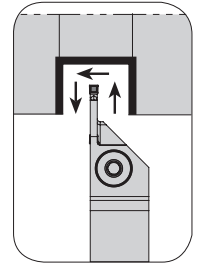
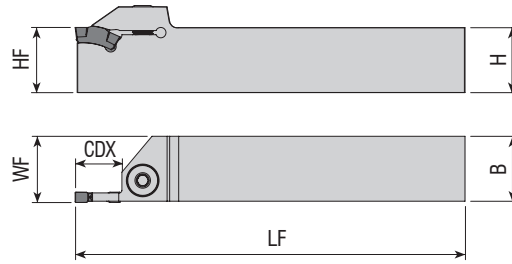

Takım Kodu Ordering Code Код для заказа	Stok Stock Наличие		Takım Ölçüleri (mm) Dimension (mm) Размеры (мм)					Kesici Uç Insert Пластина	Yedek Parçaları / Spare Parts / Запасные части		
	R	L	HF=H	B	LF	WF	CDX		Sıkma Vidası Screw Зажимной винт	Pul Stamp Шайба	Anahtar Allen Key Ключ
ADKT-ITG-R/L-2020-3-T8	●	●	20	20	125	20.3	8	TGM. - 3	2004-M8x1x20	-	AAL-05-4
ADKT-ITG-R/L-2525-3-T8	●	●	25	25	150	25.3	8				
ADKT-ITG-R/L-3232-3-T8	●	○	32	32	170	32.3	8				
ADKT-ITG-R/L-2020-4-T9	●	●	20	20	125	20.4	9	TGM. - 4			
ADKT-ITG-R/L-2525-4-T17	●	●	25	25	150	25.4	17				
ADKT-ITG-R/L-3232-4-T17	●	●	32	32	170	32.4	17	TGM. - 5			
ADKT-ITG-R/L-3232-5-T25	●	○	32	32	170	32.5	25				

ISCR Ucuna Uygun. / Compatible with ISCR Insert. / Под пластину ISCR.

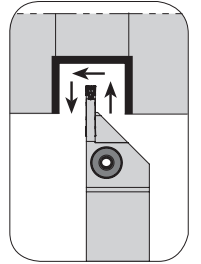
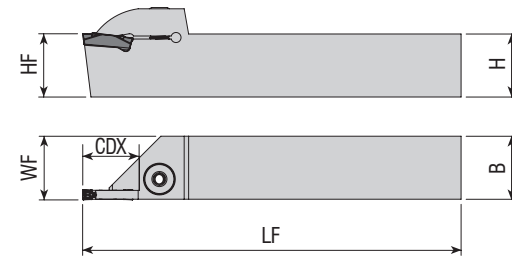
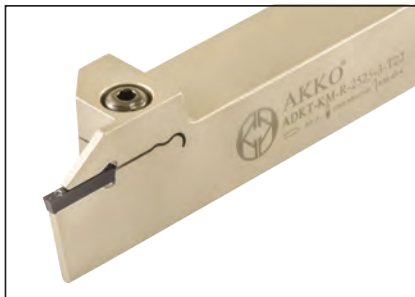

Takım Kodu Ordering Code Код для заказа	Stok Stock Наличие		Takım Ölçüleri (mm) Dimension (mm) Размеры (мм)					Kesici Uç Insert Пластина	Yedek Parçaları / Spare Parts / Запасные части		
	R	L	HF=H	B	LF	WF	CDX		Sıkma Vidası Screw Зажимной винт	Pul Stamp Шайба	Anahtar Allen Key Ключ
ADKT-KM-R/L-2020-2-T15	●	●	20	20	125	20.3	15	A4. - 2	AKV-02-M6x22	ABPL-01	AAL-03-3
ADKT-KM-R/L-2525-2-T15	●	●	25	25	150	25.3	15				
ADKT-KM-R/L-2020-3-T20	●	●	20	20	125	20.4	20	A4. - 3	2004-M8x1x20	-	AAL-05-4
ADKT-KM-R/L-2525-3-T22	●	●	25	25	150	25.4	22				
ADKT-KM-R/L-2525-4-T22	●	●	25	25	150	25.5	22	A4. - 4			

R: Sağ / Right / Правый L: Sol / Left / Левый

● Stokta / In Stock / В наличии ○ Stokta Yok / Non Stock Item / Нет в наличии

KNMTL Ucuna Uygun. / Compatible with KNMTL Insert. / Под пластину KNMTL.

Sipariş Örneği/Ordering Example/Образец заказа

1 ad./pcs./шт. ADKT-KM-R-2020-2-T15

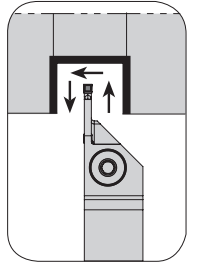
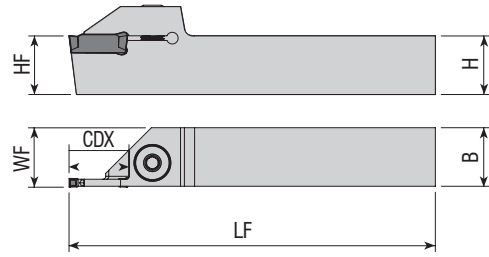

Takım Kodu Ordering Code Код для заказа	Stok Stock Наличие		Takım Ölçüleri (mm) Dimension (mm) Размеры (мм)					Kesici Uç Insert Пластина	Yedek Parçaları / Spare Parts / Запасные части			
	R	L	HF=H	B	LF	WF	CDX		Sıkma Vidası Screw Зажимной винт	Pul Stamp Шайба	Anahtar Allen Key Ключ	
ADKT-I-R/L-1212-2-T15	●	●	12	12	125	16.3	15	DGN - 2	AKV-02-M6x22	ABPL-01	AAL-03-3	
ADKT-I-R/L-1616-2-T15	●	●	16	16	100	16.3	15					
ADKT-I-R/L-2020-2-T15	●	●	20	20	125	20.3	15					
ADKT-I-R/L-2525-2-T15	●	●	25	25	150	25.3	15					
ADKT-I-R/L-3232-2-T15	●	●	32	32	170	32.3	15					
ADKT-I-R/L-1212-3-T15	●	●	12	12	100	16.3	15	DGN - 3				
ADKT-I-R/L-1616-3-T15	●	●	16	16	125	16.3	15					
ADKT-I-R/L-2020-3-T12	●	●	20	20	125	20.3	12					
ADKT-I-R/L-2020-3-T20	●	●	20	20	125	20.3	20					
ADKT-I-R/L-2525-3-T12	●	●	25	25	150	25.3	12					
ADKT-I-R/L-2525-3-T22	●	●	25	25	150	25.3	22					
ADKT-I-R/L-3232-3-T22	●	●	32	32	170	32.3	22					
ADKT-I-R/L-2020-4-T20	●	●	20	20	125	20.4	20	DGN / GRP - 4	2004-M8x1x20	-	AAL-05-4	
ADKT-I-R/L-2525-4-T12	●	●	25	25	150	25.4	12					
ADKT-I-R/L-2525-4-T22	●	●	25	25	150	25.4	22					
ADKT-I-R/L-3232-4-T25	●	●	32	32	170	32.4	25					
ADKT-I-R/L-2020-5-T20	●	●	20	20	125	20.5	20	DGN / GRP - 5				
ADKT-I-R/L-2525-5-T12	●	●	25	25	150	25.5	12					
ADKT-I-R/L-2525-5-T25	●	●	25	25	150	25.5	25	GRP - 3				
ADKT-IG-R/L-1616-3-T18	●	○	16	16	125	16.3	18					
ADKT-IG-R/L-2020-3-T12	●	●	20	20	125	20.3	12					
ADKT-IG-R/L-2020-3-R20	●	●	20	20	125	20.3	20					
ADKT-IG-R/L-2525-3-T12	●	●	25	25	150	25.3	12					
ADKT-IG-R/L-2525-3-T22	●	●	25	25	150	25.3	22					
ADKT-IGI-R/L-2020-2-T15	●	●	20	20	125	20.3	15	GIM / GIP - 2	AKV-02-M6x22	ABPL-01	AAL-03-3	
ADKT-IGI-R/L-2525-2-T15	●	●	25	25	150	25.3	15					
ADKT-IGI-R/L-1616-3-T15	●	●	16	16	125	16.3	15	GIM / GIP - 3				
ADKT-IGI-R/L-2020-3-T20	●	●	20	20	125	20.3	20					
ADKT-IGI-R/L-2525-3-T19	●	●	25	25	150	25.3	9					
ADKT-IGI-R/L-2525-3-T22	●	●	25	25	150	25.3	22					
ADKT-IGI-R/L-2525-4-T22	●	●	25	25	150	25.4	22	GIM / GIP - 4	2004-M8x1x20	-	AAL-05-4	
ADKT-IGI-R/L-2525-5-T25	●	●	25	25	150	25.5	25	GIM / GIP - 5				
ADKT-IGI-R/L-2525-8-T30	●	○	25	25	150	25.8	30	GIM / GIP - 8				
ADKT-IGTN-R/L-2525-5-T25	●	●	25	25	150	25.6	25	GTN - 5				
ADKT-IDC-R/L-2525-3-T21	●	○	25	25	150	25.4	21	DCE - 3				

R: Sağ / Right / Правый L: Sol / Left / Левый

● Stokta / In Stock / В наличии ○ Stokta Yok / Non Stock Item / Нет в наличии  
ISCR Ucuna Uygunudur. / Compatible with ISCR Insert. / Под пластину ISCR.

Sipariş Örneği/Ordering Example/Образец заказа

1 ad./pcs./шт. ADKT-I-R-1212-2-T15

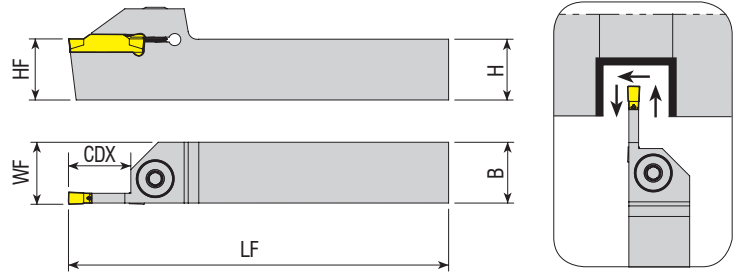

Takım Kodu Ordering Code Код для заказа	Stok Stock Наличие		Takım Ölçüleri (mm) Dimension (mm) Размеры (мм)					Kesici Uç Insert Пластина	Yedek Parçaları / Spare Parts / Запасные части		
	R	L	HF=H	B	LF	WF	CDX		Sıkma Vidası Screw Зажимной винт	Pul Stamp Шайба	Anahtar Allen Key Ключ
ADKT-123-R/L-1212-1.5-R15	●	●	12	12	100	12.2	15	123 - 1.5	AKV-02-M6x22	ABPL-01	AAL-03-3
ADKT-123-R/L-1616-1.5-R15	●	●	16	16	125	16.2	15				
ADKT-123-R/L-1616-2-T15	●	●	16	16	125	16.2	15				
ADKT-123-R/L-2020-2-T8	●	○	20	20	125	20.2	8				
ADKT-123-R/L-2020-2-T15	●	●	20	20	125	20.2	15				
ADKT-123-R/L-2525-2-T8	●	●	25	25	150	25.2	8				
ADKT-123-R/L-2525-2-T15	●	●	25	25	150	25.2	15				
ADKT-123-R/L-3232-2-T15	●	●	32	32	170	32.2	15				
ADKT-123-R/L-1616-3-T10	●	●	16	16	125	16.3	10	123 - 3	2004-M8x1x20	-	AAL-05-4
ADKT-123-R/L-1616-3-T15	●	●	16	16	125	16.3	15				
ADKT-123-R/L-2020-3-T10	●	●	20	20	125	20.3	10				
ADKT-123-R/L-2020-3-T15	●	●	20	20	125	20.3	15				
ADKT-123-R/L-2020-3-T20	●	●	20	20	125	20.3	20				
ADKT-123-R/L-2525-3-T10	●	●	25	25	150	25.3	10				
ADKT-123-R/L-2525-3-T15	●	●	25	25	150	25.3	15				
ADKT-123-R/L-2525-3-T22	●	●	25	25	150	25.3	22				
ADKT-123-R/L-2020-4-T20	●	●	20	20	125	20.4	20	123 - 4			
ADKT-123-R/L-2525-4-T13	●	●	25	25	150	25.4	13				
ADKT-123-R/L-2525-4-T22	●	●	25	25	150	25.4	22				
ADKT-123-R/L-3232-4-T25	●	●	32	32	170	32.4	25				
ADKT-123-R/L-2020-5-T20	●	●	20	20	125	20.5	20	123 - 5			
ADKT-123-R/L-2525-5-T25	●	●	25	25	150	25.5	25				
ADKT-123-R/L-3232-6-T15	●	●	32	32	170	32.5	15	123 - 6			

R: Sağ / Right / Правый L: Sol / Left / Левый  
● Stokta / In Stock / В наличии ○ Stokta Yok / Non Stock Item / Нет в наличии  
SNDVK Ucuna Uygundur. / Compatible with SNDVK Insert. / Под пластину SNDVK.

Sipariş Örneği/Ordering Example/Образец заказа  
1 ad./pcs./шт. ADKT-123-R-1212-1.5-R15

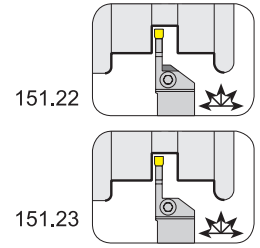
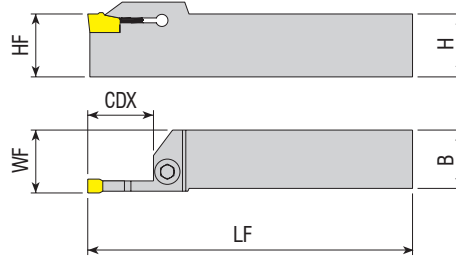
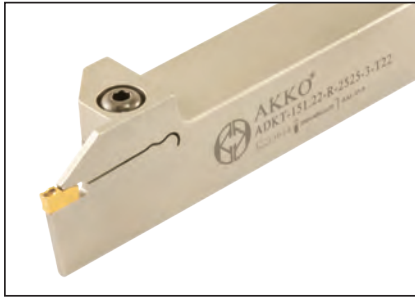

Takım Kodu Ordering Code Код для заказа	Stok Stock Наличие		Takım Ölçüleri (mm) Dimension (mm) Размеры (мм)				Kesici Uç Insert Пластина	Yedek Parçaları / Spare Parts / Запасные части			
	R	L	HF=H	B	LF	WF		Sıkma Vidası Screw Зажимной винт	Pul Stamp Шайба	Anahtar Allen Key Ключ	
ADKT-151.22-R/L-1616-2-T15	●	●	16	16	125	16.3	15	151.2 - 2	AKV-02-M6x22	ABPL-01	AAL-03-3
ADKT-151.22-R/L-2020-2-T15	●	●	20	20	125	20.3	15				
ADKT-151.22-R/L-2525-2-T15	●	●	25	25	150	25.3	15				
ADKT-151.22-R/L-1616-3-T15	●	●	16	16	125	16.4	15	151.2 - 3	2004-M8x1x20	-	AAL-05-4
ADKT-151.22-R/L-2020-3-T20	●	●	20	20	125	20.4	20				
ADKT-151.22-R/L-2525-3-T22	●	●	25	25	150	25.4	22				
ADKT-151.22-R/L-1616-4-T15	●	●	16	16	125	16.4	15	151.2 - 4	2004-M8x1x20	-	AAL-05-4
ADKT-151.22-R/L-2020-4-T20	●	●	20	20	125	20.4	20				
ADKT-151.22-R/L-2525-4-T22	●	●	25	25	150	25.4	22				
ADKT-151.22-R/L-2020-5-T20	●	●	20	20	125	20.5	20	151.2 - 5	2004-M8x1x20	-	AAL-05-4
ADKT-151.22-R/L-2525-5-T25	●	●	25	25	150	25.5	25				
ADKT-151.23-R/L-1616-2-T15	●	●	16	16	125	16.3	15	151.2 - 2	AKV-02-M6x22	ABPL-01	AAL-03-3
ADKT-151.23-R/L-2020-2-T15	●	●	20	20	125	20.3	15				
ADKT-151.23-R/L-2525-2-T15	●	●	25	25	150	25.3	15				
ADKT-151.23-R/L-1616-2.5-T15	●	●	16	16	125	16.3	15	151.2 - 2.5	2004-M8x1x20	-	AAL-05-4
ADKT-151.23-R/L-2020-2.5-T15	●	●	20	20	125	20.3	15				
ADKT-151.23-R/L-2525-2.5-T15	●	●	25	25	150	25.3	15				
ADKT-151.23-R/L-1212-3-T15	●	●	12	12	100	16.4	15	151.2 - 3	2004-M8x1x20	-	AAL-05-4
ADKT-151.23-R/L-1616-3-T15	●	●	16	16	125	16.4	15				
ADKT-151.23-R/L-2020-3-T20	●	●	20	20	125	20.4	20				
ADKT-151.23-R/L-2525-3-T20	●	●	25	25	150	25.4	20	151.2 - 4	2004-M8x1x20	-	AAL-05-4
ADKT-151.23-R/L-2525-3-T22	●	●	25	25	150	25.4	22				
ADKT-151.23-R/L-1616-4-T15	●	●	16	16	125	16.4	15				
ADKT-151.23-R/L-2020-4-T20	●	●	20	20	125	20.4	20	151.2 - 5	2004-M8x1x20	-	AAL-05-4
ADKT-151.23-R/L-2525-4-T22	●	●	25	25	150	25.4	22				
ADKT-151.23-R/L-2020-5-T20	●	●	20	20	125	20.5	20	151.2 - 5	2004-M8x1x20	-	AAL-05-4
ADKT-151.23-R/L-2525-5-T25	●	●	25	25	150	25.5	25				

R: Sağ / Right / Правый L: Sol / Left / Левый  
● Stokta / In Stock / В наличии ○ Stokta Yok / Non Stock Item / Нет в наличии  
SNDVK Ucuна Uygundur. / Compatible with SNDVK Insert. / Под пластину SNDVK.

Sipariş Örneği/Ordering Example/Образец заказа  
1 ad./pcs./шт. ADKT-151.22-R-1616-2-T15

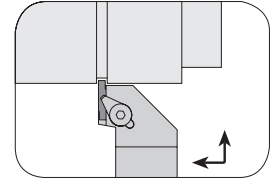
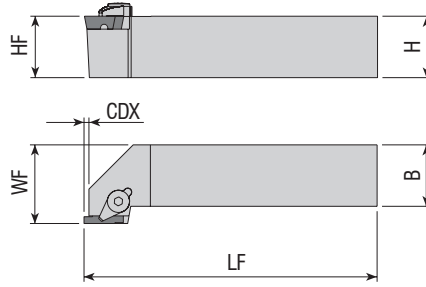

Takım Kodu Ordering Code Код для заказа	Stok Stock Наличие		Takım Ölçüleri (mm) Dimension (mm) Размеры (мм)				Kesici Uç Insert Пластина	Yedek Parçaları / Spare Parts / Запасные части				
	R	L	HF=H	B	LF	WF		CDX	Baskı Parçası Wedge Clamp Spannspratze	Sıkma Vidası Screw Зажимной винт	Pul Stamp Шайба	Anahtar Allen Key Ключ
ADKT-154.91-R/L-2020-3-T4	●	●	20	20	125	25	4	154.91 - 3	ACK-03	AKV-07-M6x22	APM-06	AAL-03-3
ADKT-154.91-R/L-2525-3-T4	●	●	25	25	150	30.5	4					
ADKT-154.91-R/L-2020-5-T5	●	●	20	20	125	25	5	154.91 - 5	ACK-03	AKV-07-M6x22	APM-06	AAL-03-3
ADKT-154.91-R/L-2525-5-T5	●	●	25	25	150	30.5	5					

SNDVK Ucuna Uygunur. / Compatible with SNDVK Insert. / Под пластину SNDVK.

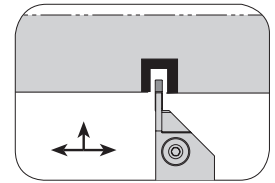
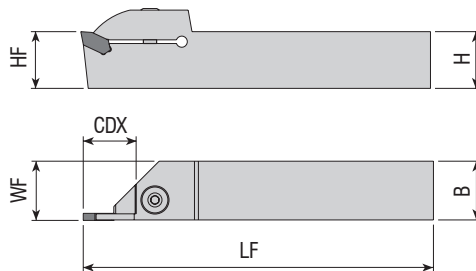
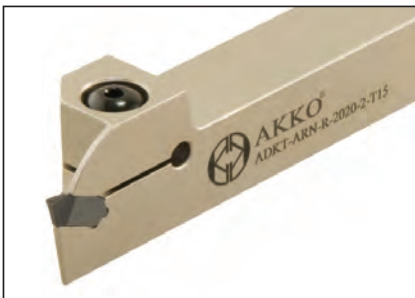

Takım Kodu Ordering Code Код для заказа	Stok Stock Наличие		Takım Ölçüleri (mm) Dimension (mm) Размеры (мм)				Kesici Uç Insert Пластина	Yedek Parçaları / Spare Parts / Запасные части			
	R	L	HF=H	B	LF	WF		CDX	Sıkma Vidası Screw Зажимной винт	Pul Stamp Шайба	Anahtar Allen Key Ключ
ADKT-ARN-R/L-2020-2-T15	●	●	20	20	125	20.3	15	LOMR. - 2	AKV-02-M6x22	ABPL-01	AAL-03-3
ADKT-ARN-R/L-2525-2-T15	●	●	25	25	150	25.3	15				
ADKT-ARN-R/L-2020-3-T20	●	●	20	20	125	20.4	20	LOMR. - 3	2004-M8x1x20	-	AAL-05-4
ADKT-ARN-R/L-2525-3-T22	●	●	25	25	150	25.4	22				

R: Sağ / Right / Правый L: Sol / Left / Левый

● Stokta / In Stock / В наличии ○ Stokta Yok / Non Stock Item / Нет в наличии

ARN Ucuna Uygunur. / Compatible with ARN Insert. / Под пластину ARN

Sipariş Örneği/Ordering Example/Образец заказа  
1 ad./pcs./шт. ADKT-154.91-R-2020-3-T4

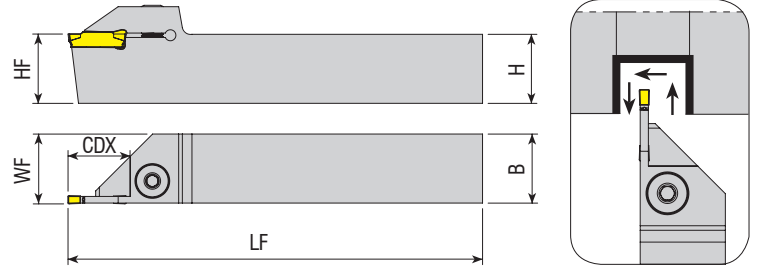

Takım Kodu Ordering Code Код для заказа	Stok Stock Наличие		Takım Ölçüleri (mm) Dimension (mm) Размеры (мм)					Kesici Uç Insert Пластина	Yedek Parçaları / Spare Parts / Залпасные части			
	R	L	HF=H	B	LF	WF	CDX		Sıkma Vidası Screw Зажимной винт	Pul Stamp Шайба	Anahtar Allen Key Ключ	
ADKT-TD-R/L-1212-2-T15	●	●	12	12	100	12.2	15	TD. - 2	AKV-02-M6x22	ABPL-01	AAL-03-3	
ADKT-TD-R/L-1616-2-T8	●	●	16	16	125	16.2	8					
ADKT-TD-R/L-1616-2-T15	●	●	16	16	125	16.2	15					
ADKT-TD-R/L-2020-2-T9	●	○	20	20	125	20.2	9					
ADKT-TD-R/L-2020-2-T15	●	●	20	20	125	20.2	15					
ADKT-TD-R/L-2020-2-T17	●	○	20	20	125	20.2	17					
ADKT-TD-R/L-2020-2-T20	●	○	20	20	125	20.2	20					
ADKT-TD-R/L-2525-2-T8	●	●	25	25	150	25.2	8					
ADKT-TD-R/L-2525-2-T17	●	●	25	25	150	25.2	17					
ADKT-TD-R/L-1212-3-T15	●	●	12	12	100	12.4	15					TD. - 3
ADKT-TD-R/L-1616-3-T15	●	●	16	16	125	16.4	15					
ADKT-TD-R/L-2020-3-T12	●	●	20	20	125	20.4	12					
ADKT-TD-R/L-2020-3-T20	●	●	20	20	125	20.4	20					
ADKT-TD-R/L-2020-3-T25	●	○	20	20	125	20.4	25					
ADKT-TD-R/L-2020-3-T30	●	●	20	20	125	20.4	30					
ADKT-TD-R/L-2525-3-T9	●	●	25	25	150	25.4	9					
ADKT-TD-R/L-2525-3-T12	●	●	25	25	150	25.4	12					
ADKT-TD-R/L-2525-3-T22	●	●	25	25	150	25.4	22					
ADKT-TD-R/L-2525-3-T25	●	●	25	25	150	25.4	25					
ADKT-TD-R/L-2525-3-T30	●	●	25	25	150	25.4	30					
ADKT-TD-R/L-3232-3-T25	●	○	32	32	170	32.4	25	TD. - 4				
ADKT-TD-R/L-2525-4-T10	●	●	25	25	150	25.5	10					
ADKT-TD-R/L-2525-4-T15	●	●	25	25	150	25.5	15					
ADKT-TD-R/L-2525-4-T22	●	●	25	25	150	25.5	22					
ADKT-TD-R/L-2525-4-T25	●	○	25	25	150	25.5	25					
ADKT-TD-R/L-2525-4-T30	●	○	25	25	150	25.5	30	TD. - 5				
ADKT-TD-R/L-2525-5-T25	●	●	25	25	150	25.5	25					

R: Sağ / Right / Правый L: Sol / Left / Левый  
● Stokta / In Stock / В наличии ○ Stokta Yok / Non Stock Item / Нет в наличии  
TGTC Ucuna Uygunudur. / Compatible with TGTC Insert. / Под пластину TGTC.

Sipariş Örneği/Ordering Example/Образец заказа  
1 ad./pcs./шт. ADKT-TD-R-1212-2-T15

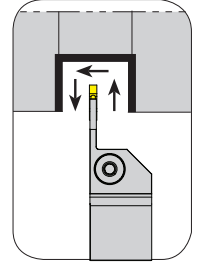
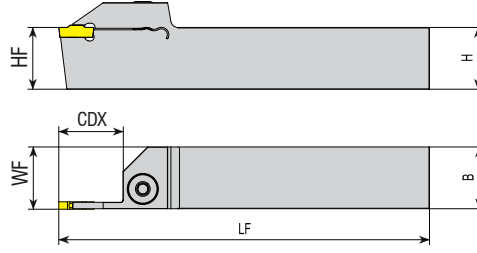

Takım Kodu Ordering Code Код для заказа	Stok Stock Наличие		Takım Ölçüleri (mm) Dimension (mm) Размеры (мм)				Kesici Uç Insert Пластина	Yedek Parçaları / Spare Parts / Запасные части			
	R	L	HF=H	B	LF	WF		Sıkma Vidası Screw Зажимной винт	Pul Stamp Шайба	Anahtar Allen Key Ключ	
ADKT-RD-R/L-1616-2-T17	●	○	16	16	125	16,2	17	RD. - 2	AKV-02-M6x22	ABPL-01	AAL-03-3
ADKT-RD-R/L-2020-2-T17	●	○	20	20	125	20,2	17				
ADKT-RD-R/L-2525-2-T17	●	●	25	25	150	25,2	17				
ADKT-RD-R/L-1616-3-T20	●	○	16	16	125	16,3	20	RD. - 3	2004-M8x1x20	-	AAL-05-4
ADKT-RD-R/L-2020-3-T25	●	○	20	20	125	20,3	25				
ADKT-RD-R/L-2525-3-T25	●	●	25	25	150	25,3	25				
ADKT-RD-R/L-2020-4-T30	●	○	20	20	125	20,5	30	RD. - 4	2004-M8x1x20	-	AAL-05-4
ADKT-RD-R/L-2525-4-T30	●	●	25	25	150	25,5	30				

TGTC Ucuna Uygundur. / Compatible with TGTC Insert. / Под пластину TGTC.

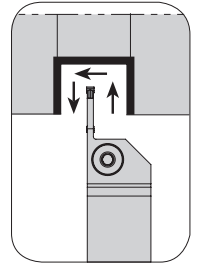
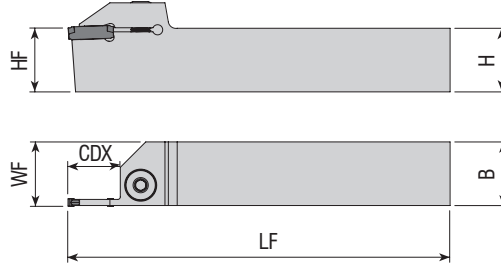

Takım Kodu Ordering Code Код для заказа	Stok Stock Наличие		Takım Ölçüleri (mm) Dimension (mm) Размеры (мм)				Kesici Uç Insert Пластина	Yedek Parçaları / Spare Parts / Запасные части			
	R	L	HF=H	B	LF	WF		CDX	Sıkma Vidası Screw Зажимной винт	Pul Stamp Шайба	Anahtar Allen Key Ключ
ADKT-LGC-R/L-1616-2-D40	●	●	16	16	125	16,2	20	GCTX - 2	AKV-02-M6x22	ABPL-01	AAL-03-3
ADKT-LGC-R/L-2020-2-D40	●	●	20	20	125	20,2	20				
ADKT-LGC-R/L-2525-2-D40	●	●	25	25	150	25,2	20				
ADKT-LGC-R/L-1616-3-T20	●	●	16	16	125	16,3	20	GCTX - 3	2004-M8x1x20	-	AAL-05-4
ADKT-LGC-R/L-2020-3-T20	●	●	20	20	125	20,3	20				
ADKT-LGC-R/L-2525-3-T20	●	●	25	25	150	25,3	20				

R: Sağ / Right / Правый L: Sol / Left / Левый  
● Stokta / In Stock / В наличии ○ Stokta Yok / Non Stock Item / Нет в наличии  
LMN Ucuna Uygundur. / Compatible with LMN Insert. / Под пластину LMN

Sipariş Örneği/Ordering Example/Образец заказа  
1 ad./pcs./шт. ADKT-RD-R-1616-2-T17



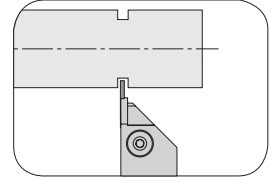
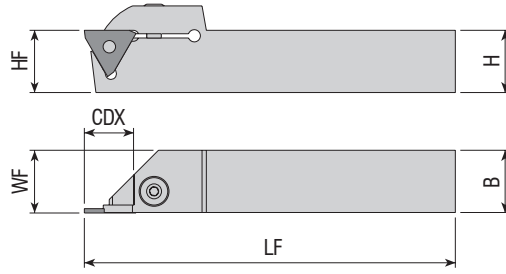

Takım Kodu Ordering Code Код для заказа	Stok Stock Наличие		Takım Ölçüleri (mm) Dimension (mm) Размеры (мм)				Kesici Uç Insert Пластина	Yedek Parçaları / Spare Parts / Запасные части				
	R	L	HF=H	B	LF	WF	CDX	Sıkma Vidası Screw Зажимной винт	Baskı Pabucu Wedge Clamp Прижим	Sekman Ring Кольцо	Anahtar Allen Key Ключ	
ADKT-H22-R/L-1616-(0.5-2)-T4	●	●	16	16	125	16.2	4					
ADKT-H22-R/L-2020-(0.5-2)-T4	●	●	20	20	125	20.2	4	<b>S312 - (0.5-2)</b>	AKV-29-M6x29	AKK-04	AS-01	AAL-03-3
ADKT-H22-R/L-2525-(0.5-2)-T4	●	●	25	25	150	25.2	4					

HRN Ucuna Uygundur. / Compatible with HRN Insert. / Под пластину HRN

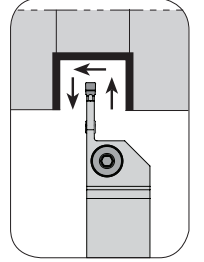
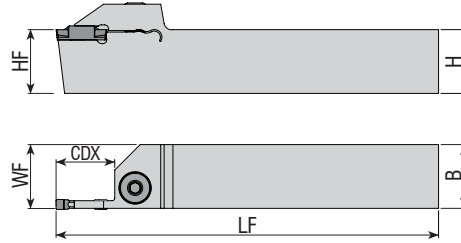

Takım Kodu Ordering Code Код для заказа	Stok Stock Наличие		Takım Ölçüleri (mm) Dimension (mm) Размеры (мм)				Kesici Uç Insert Пластина	Yedek Parçaları / Spare Parts / Запасные части			
	R	L	HF=H	B	LF	WF	CDX	Sıkma Vidası Screw Зажимной винт	Pul Stamp Шайба	Anahtar Allen Key Ключ	
ADKT-TG-R/L-1616-2-R17	●	○	16	16	125	16.2	17	<b>DGM2-020</b>	AKV-02-M6x22	ABPL-01	AAL-03-3
ADKT-TG-R/L-2020-2-R8	●	○	20	20	125	20.2	8				
ADKT-TG-R/L-2020-2-R12	●	○	20	20	125	20.2	12				
ADKT-TG-R/L-2020-2-R17	●	○	20	20	125	20.2	17	<b>DGM3-020</b>	2004-M8x1x20	-	AAL-05-4
ADKT-TG-R/L-2525-2-R12	●	○	25	25	150	25.2	12				
ADKT-TG-R/L-2525-2-R17	●	○	25	25	150	25.2	17				
ADKT-TG-R/L-1616-3-T20	●	○	16	16	125	16.3	20	<b>DGM4-030</b>	2004-M8x1x20	-	AAL-05-4
ADKT-TG-R/L-2020-3-T12	●	○	20	20	125	20.3	12				
ADKT-TG-R/L-2020-3-T20	●	○	20	20	125	20.3	20				
ADKT-TG-R/L-2525-3-T9	●	○	25	25	150	25.3	9	<b>DGM5-030</b>	2004-M8x1x20	-	AAL-05-4
ADKT-TG-R/L-2525-3-T20	●	○	25	25	150	25.3	20				
ADKT-TG-R/L-2525-3-R25	●	○	25	25	150	25.3	25				
ADKT-TG-R/L-2525-4-T15	●	○	25	25	150	25.5	15	<b>DGM5-030</b>	2004-M8x1x20	-	AAL-05-4
ADKT-TG-R/L-2525-4-T20	●	○	25	25	150	25.5	20				
ADKT-TG-R/L-2525-4-T25	●	○	25	25	150	25.5	25				
ADKT-TG-R/L-2525-5-T12	●	○	25	25	150	25.5	12	<b>DGM5-030</b>	2004-M8x1x20	-	AAL-05-4
ADKT-TG-R/L-2525-5-T25	●	○	25	25	150	25.5	25				
ADKT-TG-R/L-2525-5-T32	●	○	25	25	150	25.5	32				

R: Sağ / Right / Правый L: Sol / Left / Левый

● Stokta / In Stock / В наличии ○ Stokta Yok / Non Stock Item / Нет в наличии

TNGLY Ucuna Uygundur. / Compatible with TNGLY Insert. / Под пластину TNGLY

Sipariş Örneği/Ordering Example/Образец заказа

1 ad./pcs./шт. ADKT-H22-R-1616-(0.5-2)T4



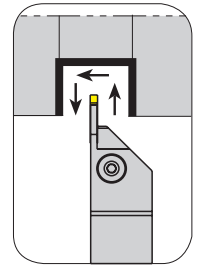
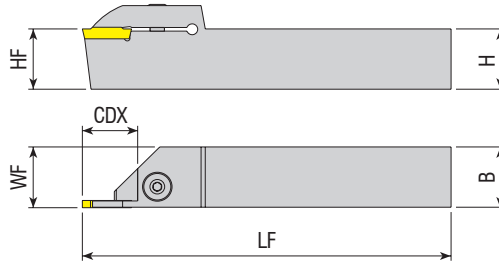
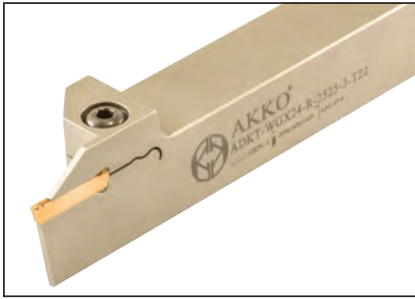

Takım Kodu Ordering Code Код для заказа	Stok Stock Наличие		Takım Ölçüleri (mm) Dimension (mm) Размеры (мм)				Kesici Uç Insert Пластина	Yedek Parçaları / Spare Parts / Запасные части			
	R	L	HF=H	B	LF	WF		CDX	Sıkma Vidası Screw Зажимной винт	Pul Stamp Шайба	Anahtar Allen Key Ключ
ADKT-WGX16-R/L-2020-2-R16	●	○	20	20	125	20.2	16	GX16. - 2	AKV-02-M6x22	ABPL-01	AAL-03-3
ADKT-WGX16-R/L-2525-2-R16	●	○	25	25	150	25.2	16				
ADKT-WGX24-R/L-2020-3-T20	●	●	20	20	125	20.4	20	GX24. - 3	2004-M8x1x20	-	AAL-05-4
ADKT-WGX24-R/L-2525-3-T12	●	●	25	25	150	25.4	12				
ADKT-WGX24-R/L-2525-3-T22	●	●	25	25	150	25.4	22				
ADKT-WGX24-R/L-3232-3-T22	●	○	32	32	170	32.4	22				
ADKT-WGX24-R/L-2525-4-T22	●	●	25	25	150	25.5	22				
ADKT-WGX24-R/L-2525-5-T25	●	●	25	25	150	25.5	25	GX24. - 5			
ADKT-WGX24-R/L-3232-5-T25	●	●	32	32	170	32.5	25				

WLTR Ucuna Uygundur. / Compatible with WLTR Insert. / Под пластину WLTR

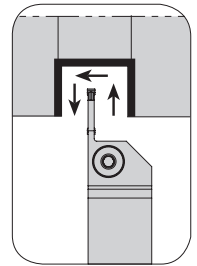
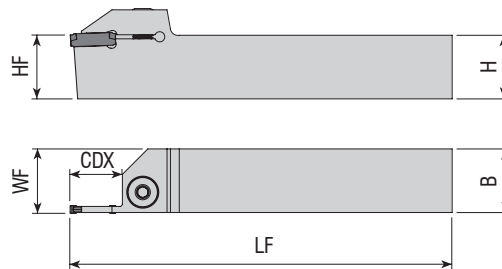

Takım Kodu Ordering Code Код для заказа	Stok Stock Наличие		Takım Ölçüleri (mm) Dimension (mm) Размеры (мм)				Kesici Uç Insert Пластина	Yedek Parçaları / Spare Parts / Запасные части			
	R	L	HF=H	B	LF	WF		CDX	Sıkma Vidası Screw Зажимной винт	Pul Stamp Шайба	Anahtar Allen Key Ключ
ADKT-GP-R/L-2020-2-T15	●	●	20	20	125	20.2	15	GP - 2	AKV-02-M6x22	ABPL-01	AAL-03-3
ADKT-GP-R/L-2525-2-T15	●	●	25	25	150	25.2	15				
ADKT-GP-R/L-2020-3-T20	●	●	20	20	125	20.3	20	GP - 3	2004-M8x1x20	-	AAL-05-4
ADKT-GP-R/L-2525-3-T22	●	●	25	25	150	25.3	22				
ADKT-GP-R/L-2525-4-T22	●	●	25	25	150	25.4	22				
ADKT-GP-R/L-2525-5-T25	●	●	25	25	150	25.5	25				
ADKT-GP-R/L-2525-5-T25	●	●	25	25	150	25.5	25				

R: Sağ / Right / Правый L: Sol / Left / Левый  
● Stokta / In Stock / В наличии ○ Stokta Yok / Non Stock Item / Нет в наличии  
PLBT Ucuna Uygundur. / Compatible with PLBT Insert. / Под пластину PLBT.

Sipariş Örneği/Ordering Example/Образец заказа  
1 ad./pcs./шт. ADKT-WGX16-R-2020-2-R16

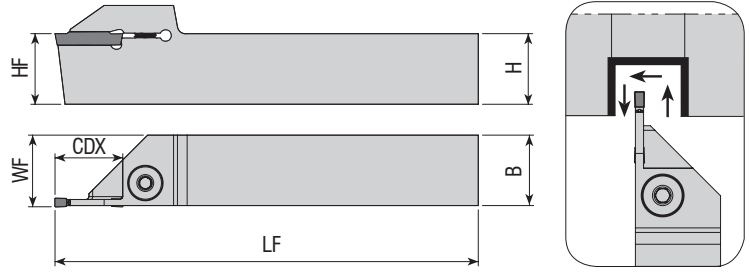

Takım Kodu Ordering Code Код для заказа	Stok Stock Наличие		Takım Ölçüleri (mm) Dimension (mm) Размеры (мм)				Kesici Uç Insert Пластина	Yedek Parçaları / Spare Parts / Запасные части			
	R	L	HF=H	B	LF	WF		CDX	Sıkma Vidası Screw Зажимной винт	Pul Stamp Шайба	Anahtar Allen Key Ключ
ADKT-CD-R/L-2020-3-R20	●	○	20	20	125	20.3	20	GX24 0300	2004-M8x1x20	-	AAL-05-4
ADKT-CD-R/L-2525-3-R23	●	○	25	25	150	25.3	23				

CRTZT Ucuna Uygun. / Compatible with CRTZT Insert. / Под пластину CRTZT

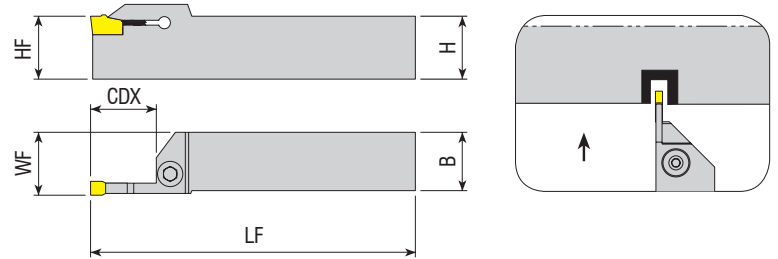

Takım Kodu Ordering Code Код для заказа	Stok Stock Наличие		Takım Ölçüleri (mm) Dimension (mm) Размеры (мм)				Kesici Uç Insert Пластина	Yedek Parçaları / Spare Parts / Запасные части			
	R	L	HF=H	B	LF	WF		CDX	Sıkma Vidası Screw Зажимной винт	Pul Stamp Шайба	Anahtar Allen Key Ключ
ADKT-SWC-R/L-2020-2-T25	●	○	20	20	125	20.3	25	WCF - 2	AKV-02-M6x22	ABPL-01	AAL-03-3
ADKT-SWC-R/L-2020-3-T25	●	○	20	20	125	20.4	25				

R: Sağ / Right / Правый L: Sol / Left / Левый  
● Stokta / In Stock / В наличии ○ Stokta Yok / Non Stock Item / Нет в наличии  
SMTM Ucuna Uygun. / Compatible with SMTM Insert. / Под пластину SMTM.

Sipariş Örneği/Ordering Example/Образец заказа  
1 ad./pcs./шт. ADKT-CD-R-2020-3-R20

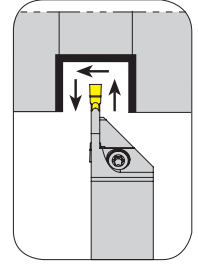
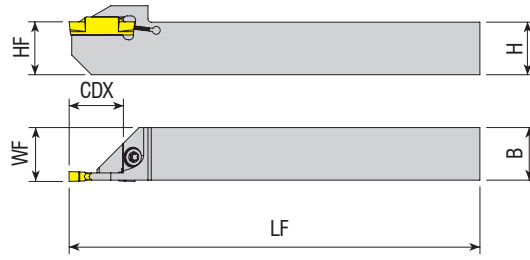

Takım Kodu Ordering Code Код для заказа	Stok Stock Наличие		Takım Ölçüleri (mm) Dimension (mm) Размеры (мм)				Kesici Uç Insert Пластина	Yedek Parçaları / Spare Parts / Запасные части			
	R	L	HF=H	B	LF	WF		CDX	Sıkma Vidası Screw Зажимной винт	Pul Stamp Шайба	Anahtar Allen Key Ключ
ADKT-TD-R/L-1212-2-T12-K-S	●	●	12	12	125	12.2	12	TD - 2	4015-M4x11	-	80-T15
ADKT-TD-R/L-1616-2-T16-K-S	●	●	16	16	125	16.2	16				
ADKT-TD-R/L-1212-3-T12-K-S	●	●	12	12	125	12.3	12	TD - 3	4015-M4x11	-	80-T15
ADKT-TD-R/L-1616-3-T16-K-S	●	●	16	16	125	16.3	16				

TGTC Ucuna Uygundur. / Compatible with TGTC Insert. / Под пластину TGTC.

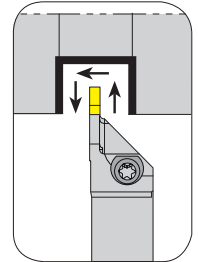
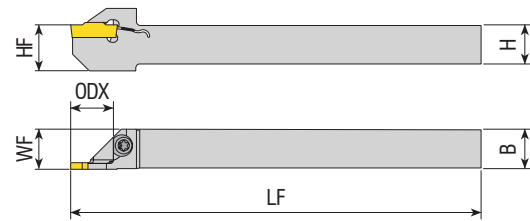

Takım Kodu Ordering Code Код для заказа	Stok Stock Наличие		Takım Ölçüleri (mm) Dimension (mm) Размеры (мм)				Kesici Uç Insert Пластина	Yedek Parçaları / Spare Parts / Запасные части			
	R	L	HF=H	B	LF	WF		CDX	Sıkma Vidası Screw Зажимной винт	Pul Stamp Шайба	Tork Anahtar Torx Key Торх Ключ
ADKT-RD-R/L-1212-2-T12-K-S	●	●	12	12	125	12.2	12	RD - 2	4015-M4x11	-	80-T15
ADKT-RD-R/L-1616-2-T17-K-S	○	●	16	16	125	16.2	17				
ADKT-RD-R/L-1212-3-T12-K-S	●	●	12	12	125	12.2	12	RD - 3	4015-M4x11	-	80-T15

R: Sağ / Right / Правый L: Sol / Left / Левый  
● Stokta / In Stock / В наличии ○ Stokta Yok / Non Stock Item / Нет в наличии  
TGTC Ucuna Uygundur. / Compatible with TGTC Insert. / Под пластину TGTC.

Sipariş Örneği/Ordering Example/Образец заказа  
1 ad./pcs./шт. ADKT-TD-R-1212-2-T12-K-S

DIŞ ÇAP KANAL AÇMA İSVİÇRE TİPİ KAYAR OTOMAT MAKİNA TAKIMLARI

EXTERNAL GROOVING TOOLHOLDERS FOR SWISS TYPE SLIDING AUTOMATIC LATHES

ДЕРЖАВКИ ДЛЯ ОБРАБОТКИ НАРУЖНЫХ КАНАВОК ДЛЯ ТОКАРНЫХ СТАНКОВ ШВЕЙЦАРСКОГО ТИПА

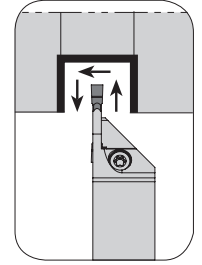
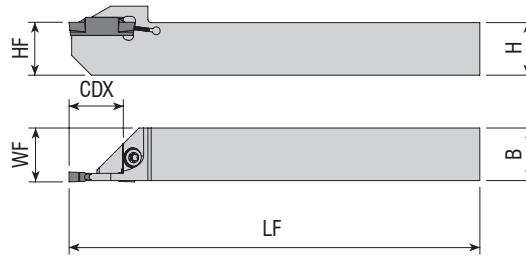

Takım Kodu Ordering Code Код для заказа	Stok Stock Наличие		Takım Ölçüleri (mm) Dimension (mm) Размеры (мм)					Kesici Uç Insert Пластина	Yedek Parçaları / Spare Parts / Запасные части		
	R	L	HF=H	B	LF	WF	CDX		Sıkma Vidası Screw Зажимной винт	Pul Stamp Шайба	Anahtar Allen Key Ключ
ADKT-ZCC2-R/L-1010-2-T12-K-S	●	●	10	10	125	10.2	12	Z.BD - 2	4015-M4x11	-	80-T15
ADKT-ZCC2-R/L-1212-2-T12-K-S	●	●	12	12	125	12.2	12				
ADKT-ZCC2-R/L-1616-2-R16-K-S	●	●	16	16	125	16.2	16	Z.FD - 3			
ADKT-ZCC2-R/L-1212-3-T12-K-S	●	●	12	12	125	12.3	12				

ZCC Ucuna Uygundur. / Compatiple with ZCC Insert. / Под пластину ZCC.

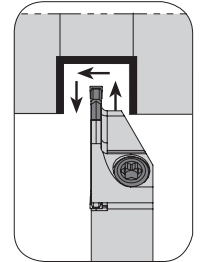
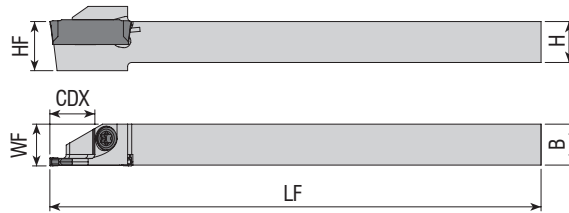

Takım Kodu Ordering Code Код для заказа	Stok Stock Наличие		Takım Ölçüleri (mm) Dimension (mm) Размеры (мм)					Kesici Uç Insert Пластина	Yedek Parçaları / Spare Parts / Запасные части		
	R	L	HF=H	B	LF	WF	CDX		Sıkma Vidası Screw Зажимной винт	Pul Stamp Шайба	Anahtar Allen Key Ключ
ADKT-I-R/L-0808-2-R10-S	●	●	08	08	100	8.2	10	DGN - 2	4015-M4x11	-	80-T15
ADKT-I-R/L-1010-2-R10-K-S	●	●	10	10	125	10.2	10				
ADKT-I-R/L-1212-2-R12-K-S	●	●	12	12	125	12.2	12	DGN - 3			
ADKT-I-R/L-1616-3-R16-K-S	●	●	16	16	125	16.3	16				

R: Sağ / Right / Правый L: Sol / Left / Левый

● Stokta / In Stock / В наличии ○ Stokta Yok / Non Stock Item / Нет в наличии

ISCR Ucuna Uygundur. / Compatiple with ISCR Insert. / Под пластину ISCR.

Sipariş Örneği/Ordering Example/Образец заказа

1 ad./pcs./шт. ADKT-ZCC2-R-1010-2-T12-K-S

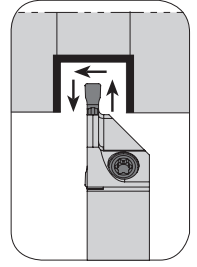
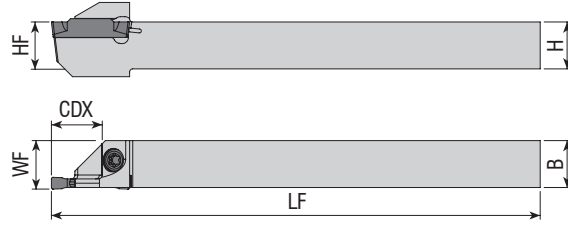

Takım Kodu Ordering Code Код для заказа	Stok Stock Наличие		Takım Ölçüleri (mm) Dimension (mm) Размеры (мм)				Kesici Uç Insert Пластина	Yedek Parçaları / Spare Parts / Запасные части			
	R	L	HF=H	B	LF	WF		CDX	Sıkma Vidası Screw Зажимной винт	Pul Stamp Шайба	Anahtar Allen Key Ключ
ADKT-KG-R/L-1212-2-R12-K-S	●	●	12	12	125	12.2	12	KG. - 2	4015-M4x11	-	80-T15
ADKT-KG-R/L-1616-2-R16-K-S	●	●	16	16	125	16.2	16				
ADKT-KG-R/L-1212-3-R12-K-S	●	●	12	12	125	12.3	12	KG. - 3	4015-M4x11	-	80-T15
ADKT-KG-R/L-1616-3-R16-K-S	●	●	16	16	125	16.3	16				

KRLY Ucuna Uygun. / Compatible with KRLY Insert. / Под пластину KRLY.

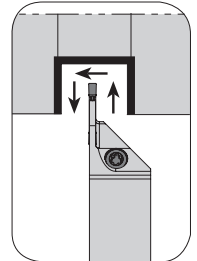
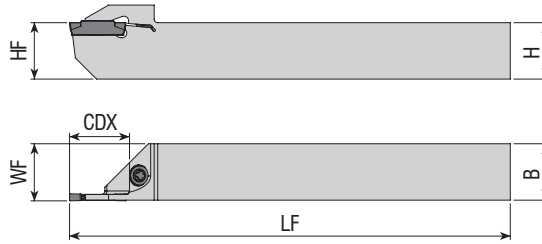

Takım Kodu Ordering Code Код для заказа	Stok Stock Наличие		Takım Ölçüleri (mm) Dimension (mm) Размеры (мм)				Kesici Uç Insert Пластина	Yedek Parçaları / Spare Parts / Запасные части			
	R	L	HF=H	B	LF	WF		CDX	Sıkma Vidası Screw Зажимной винт	Pul Stamp Шайба	Anahtar Allen Key Ключ
ADKT-K-R/L-1212-2-R12-K-S	●	●	12	12	125	12.20	12	MGM. - 2	4015-M4x11	-	80-T15
ADKT-K-R/L-1616-2-R16-K-S	●	●	16	16	125	16.20	16				
ADKT-K-R/L-1212-3-R12-K-S	●	●	12	12	125	12.30	12	MGM. - 3	4015-M4x11	-	80-T15
ADKT-K-R/L-1616-3-R16-K-S	●	●	16	16	125	16.30	16				

R: Sağ / Right / Правый L: Sol / Left / Левый

● Stokta / In Stock / В наличии ○ Stokta Yok / Non Stock Item / Нет в наличии

KRLY Ucuna Uygun. / Compatible with KRLY Insert. / Под пластину KRLY.

Sipariş Örneği/Ordering Example/Образец заказа  
1 ad./pcs./шт. ADKT-KG-R-1212-2-R12-K-S

DIŞ ÇAP KANAL AÇMA İSVİÇRE TİPİ KAYAR OTOMAT MAKİNA TAKIMLARI

EXTERNAL GROOVING TOOLHOLDERS FOR SWISS TYPE SLIDING AUTOMATIC LATHES

ДЕРЖАВКИ ДЛЯ ОБРАБОТКИ НАРУЖНЫХ КАНАВOK ДЛЯ ТОКАРНЫХ СТАНКОВ ШВЕЙЦАРСКОГО ТИПА

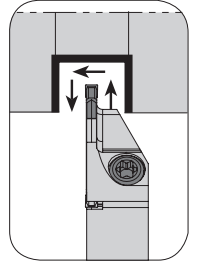
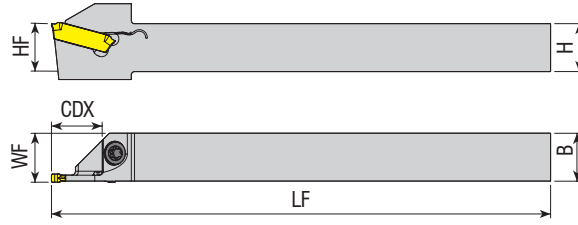

Takım Kodu Ordering Code Код для заказа	Stok Stock Наличие		Takım Ölçüleri (mm) Dimension (mm) Размеры (мм)				Kesici Uç Insert Пластина	Yedek Parçaları / Spare Parts / Запасные части			
	R	L	HF=H	B	LF	WF		CDX	Sıkma Vidası Screw Зажимной винт	Pul Stamp Шайба	Anahtar Allen Key Ключ
ADKT-WGX16-R/L-1212-2-R12-K-S	●	●	12	12	125	12.2	12	GX16. - 2	4015-M4x11	-	80-T15
ADKT-WGX16-R/L-1616-2-R16-K-S	●	○	16	16	125	16.2	16				
ADKT-WGX24-R/L-1616-3-R16-K-S	●	○	16	16	125	16.3	16	GX24. - 3			

WLTR Ucuna Uygundur. / Compatible with WLTR Insert. / Под пластину WLTR

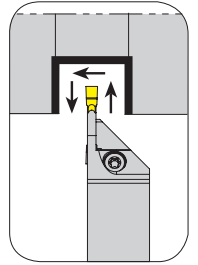
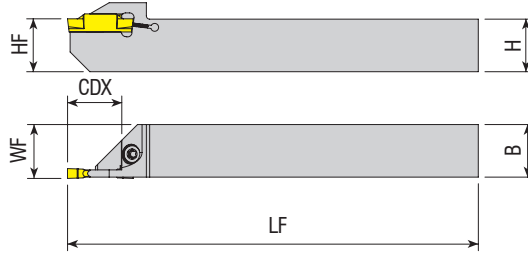

Takım Kodu Ordering Code Код для заказа	Stok Stock Наличие		Takım Ölçüleri (mm) Dimension (mm) Размеры (мм)				Kesici Uç Insert Пластина	Yedek Parçaları / Spare Parts / Запасные части			
	R	L	HF=H	B	LF	WF		CDX	Sıkma Vidası Screw Зажимной винт	Pul Stamp Шайба	Tork Anahtar Torx Key Торх Ключ
ADKT-TG-R/L-1212-2-R12-K-S	●	○	12	12	125	12.2	12	DGM2-020 DGM3-020	4015-M4x11	-	80-T15
ADKT-TG-R/L-1212-3-R12-K-S	●	○	12	12	125	12.3	12				

R: Sağ / Right / Правый L: Sol / Left / Левый

● Stokta / In Stock / В наличии ○ Stokta Yok / Non Stock Item / Нет в наличии

TNGLY Ucuna Uygundur. / Compatible with TNGLY Insert. / Под пластину TNGLY

Sipariş Örneği/Ordering Example/Образец заказа

1 ad./pcs./шт. ADKT-WGX16-R-1212-2-R12-K-S

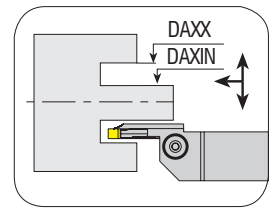
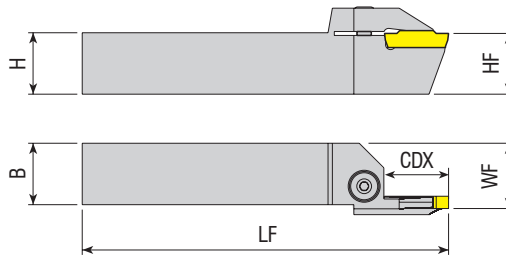

**Takım Kodu**  
**Ordering Code**  
Код для заказа

Takım Kodu Ordering Code Код для заказа	Stok Stock Наличие		Takım Ölçüleri (mm) Dimension (mm) Размеры (мм)							Kesici Uç Insert Пластина	Yedek Parçaları / Spare Parts / Запасные части		
	R	L	HF=H	B	LF	WF	CDX	DAXIN	DAXX	Sıkma Vidası Screw Зажимной винт	Pul Stamp Шайба	Anahtar Allen Key Ключ	
AAKT-K-R/L-2525-34-45-3-T17	●	●	25	25	150	26.5	17	34	45	MGM. - 3			
AAKT-K-R/L-2525-39-55-3-T17	●	●	25	25	150	26.5	17	39	55				
AAKT-K-R/L-2525-49-80-3-T17	●	●	25	25	150	26.5	17	49	80				
AAKT-K-R/L-2525-70-110-3-T17	●	●	25	25	150	26.5	17	70	110				
AAKT-K-R/L-2525-100-150-3-T17	●	●	25	25	150	26.5	17	100	150				
AAKT-K-R/L-2525-80-180-3-T32	●	●	25	25	150	26.5	32	80	180				
AAKT-K-R/L-2525-175-215-3-T22	●	●	25	25	150	26.5	22	175	215				
AAKT-K-R/L-2525-700-800-3-T17	●	●	25	25	150	26.5	17	700	800	MGM. - 4	2004-M8x1x20	-	AAL-05-4
AAKT-K-R/L-2525-50-85-4-T22	●	●	25	25	150	26.5	22	50	85				
AAKT-K-R/L-2525-70-110-4-T22	●	●	25	25	150	26.5	22	70	110				
AAKT-K-R/L-2525-100-150-4-T22	●	●	25	25	150	26.5	22	100	150				
AAKT-K-R/L-2525-80-180-4-T32	●	●	25	25	150	26.5	32	80	180				
AAKT-K-R/L-2525-180-800-4-T32	●	●	25	25	150	26.5	32	180	800				
AAKT-K-R/L-2525-70-110-5-T25	●	●	25	25	150	26.5	25	70	110				
AAKT-K-R/L-2525-100-150-5-T25	●	●	25	25	150	26.5	25	100	150				
AAKT-K-R/L-2525-80-180-5-T32	●	●	25	25	150	26.5	32	80	180				
AAKT-K-R/L-2525-140-200-5-T25	●	●	25	25	150	26.5	25	140	200				
AAKT-K-R/L-2525-180-800-5-T32	●	●	25	25	150	26.5	32	180	800				
AAKT-K-R/L-2525-60-100-6-T25	●	●	25	25	150	26.5	25	60	100				
AAKT-K-R/L-2525-60-100-6-T35	●	○	25	25	150	26.5	35	60	100	MGM. - 6			
AAKT-K-R/L-2525-100-200-6-T25	●	○	25	25	150	26.5	25	100	200				
AAKT-K-R/L-2525-100-200-6-T35	●	○	25	25	150	26.5	35	100	200				
AAKT-K-R/L-2525-100-200-6-T45	●	○	25	25	150	26.5	45	100	200				
AAKT-K-R/L-2525-140-300-6-T35	●	●	25	25	150	26.5	35	140	300	MGM. - 8			
AAKT-K-R/L-2525-140-300-8-T35	●	○	25	25	150	26.5	35	140	300				
AAKT-K-R/L-3232-140-350-8-T35	●	○	32	32	150	33.5	35	140	350				

R: Sağ / Right / Правый L: Sol / Left / Левый  
● Stokta / In Stock / В наличии ○ Stokta Yok / Non Stock Item / Нет в наличии  
KRLY Ucuna Uygunudur. / Compatible with KRLY Insert. / Под пластину KRLY.

Sipariş Örneği/Ordering Example/Образец заказа  
1 ad./pcs./шт. AAKT-K-R-2525-34-45-3-T17



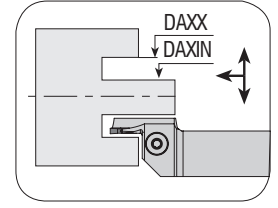
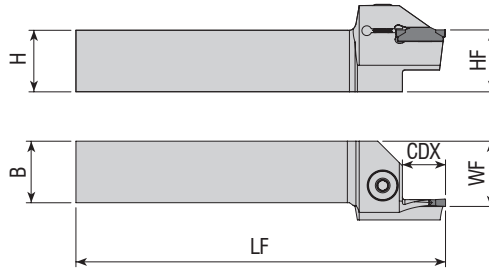

**Takım Kodu**  
**Ordering Code**  
Код для заказа

Takım Kodu Ordering Code Код для заказа	Takım Ölçüleri (mm) Dimension (mm) Размеры (мм)									Kesici Uç Insert Пластина	Yedek Parçaları / Spare Parts / Запасные части			
	R	L	HF=H	B	LF	WF	CDX	DAXIN	DAXX		Sıkma Vidası Screw Зажимной винт	Pul Stamp Шайба	Anahtar Allen Key Ключ	
AAKT-ZCC2-R/L-2525-140-180-2-T4	●	○	25	25	150	26.5	4	140	180	Z.BD - 2	2004-M8x1x20	-	AAL-05-4	
AAKT-ZCC2-R/L-2525-35-45-3-T17	●	●	25	25	150	26.5	17	35	45	Z.FD - 3				
AAKT-ZCC2-R/L-2525-39-55-3-T17	●	○	25	25	150	26.5	17	39	55					
AAKT-ZCC2-R/L-2525-49-80-3-T17	●	●	25	25	150	26.5	17	49	80					
AAKT-ZCC2-R/L-2525-70-110-3-T15	●	○	25	25	150	26.5	15	70	110					
AAKT-ZCC2-R/L-2525-70-110-3-T17	●	●	25	25	150	26.5	17	70	110					
AAKT-ZCC2-R/L-2525-100-150-3-T17	●	●	25	25	150	26.5	17	100	150					
AAKT-ZCC2-R/L-2525-40-60-4-T22	●	○	25	25	150	26.5	22	40	60	Z.GD - 4				
AAKT-ZCC2-R/L-2525-52-80-4-T22	●	●	25	25	150	26.5	22	52	80					
AAKT-ZCC2-R/L-2525-72-110-4-T22	●	●	25	25	150	26.5	22	72	110					
AAKT-ZCC2-R/L-2525-100-150-4-T22	●	●	25	25	150	26.5	22	100	150					
AAKT-ZCC2-R/L-2525-140-200-4-T22	●	●	25	25	150	26.5	22	140	200					
AAKT-ZCC2-R/L-2525-55-95-5-T25	●	○	25	25	150	26.5	25	55	95	Z.HD - 5				
AAKT-ZCC2-R/L-2525-85-140-5-T25	●	●	25	25	150	26.5	25	85	140					
AAKT-ZCC2-R/L-2525-130-200-5-T25	●	○	25	25	150	26.5	25	130	200					
AAKT-ZCC2-R/L-2525-190-400-5-T25	●	●	25	25	150	26.5	25	190	400					
AAKT-ZCC2-R/L-2525-190-400-5-T35	●	○	25	25	150	26.5	35	190	400					
AAKT-ZCC2-R/L-2525-200-500-5-T17	●	●	25	25	150	26.5	17	200	500					
AAKT-ZCC2-R/L-2525-60-110-6-T15	●	○	25	25	150	26.5	15	60	110	Z.KD - 6				

ZCC Ucuna Uygunudur. / Compatible with ZCC Insert. / Под пластину ZCC.

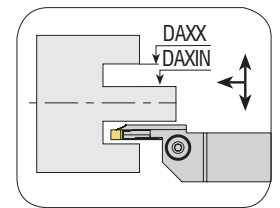
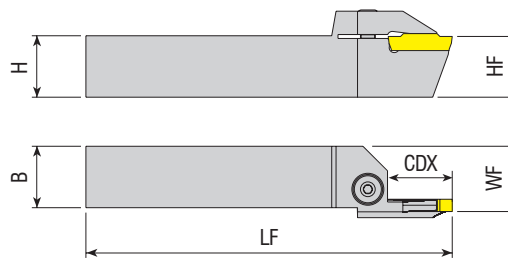

**Takım Kodu**  
**Ordering Code**  
Код для заказа

Takım Kodu Ordering Code Код для заказа	Stok Stock Наличие	Takım Ölçüleri (mm) Dimension (mm) Размеры (мм)									Kesici Uç Insert Пластина	Yedek Parçaları / Spare Parts / Запасные части			
		R	L	HF=H	B	LF	WF	CDX	DAXIN	DAXX		Sıkma Vidası Screw Зажимной винт	Pul Stamp Шайба	Anahtar Allen Key Ключ	
AAKT-KG-R/L-2525-44-70-4-T22	○	○	25	25	150	26.5	22	44	70	KG.. - 4	2004-M8x1x20	-	AAL-05-4		
AAKT-KG-R/L-2525-60-120-4-T22	○	○	25	25	150	26.5	22	60	120						
AAKT-KG-R/L-2525-112-200-4-T22	○	○	25	25	150	26.5	22	112	200						

R: Sağ / Right / Правый L: Sol / Left / Левый  
● Stokta / In Stock / В наличии ○ Stokta Yok / Non Stock Item / Нет в наличии  
KRLY Ucuna Uygunudur. / Compatible with KRLY Insert. / Под пластину KRLY.

Sipariş Örneği/Ordering Example/Образец заказа  
1 ad./pcs./шт. AAKT-ZCC2-R-2525-140-180-2-T4

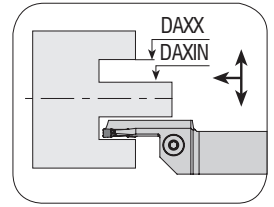
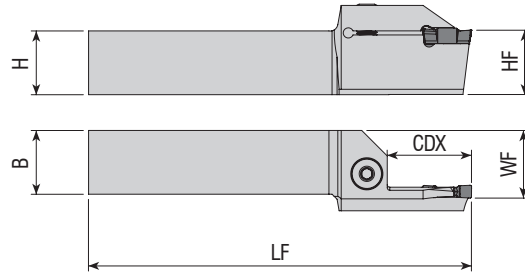

**Takım Kodu**  
**Ordering Code**  
Код для заказа

Stok Stock Наличие	Takım Ölçüleri (mm) Dimension (mm) Размеры (мм)									Kesici Uç Insert Пластина	Yedek Parçaları / Spare Parts / Запасные части		
	R	L	HF=H	B	LF	WF	CDX	DAXIN	DAXX		Sıkma Vidası Screw Зажимной винт	Pul Stamp Шайба	Anahtar Allen Key Ключ
AAKT-IG-R/L-2525-40-60-4-T25	●	●	25	25	150	26.5	25	40	60	DGN / GRP - 4	2004-M8x1x20	-	AAL-05-4
AAKT-IG-R/L-2525-52-80-4-T25	●	●	25	25	150	26.5	25	52	80				
AAKT-IG-R/L-2525-70-110-4-T28	●	●	25	25	150	26.5	28	70	110				
AAKT-IG-R/L-2525-72-110-4-T25	○	○	25	25	150	26.5	25	72	110				
AAKT-IG-R/L-2525-100-150-4-T25	●	○	25	25	150	26.5	25	100	150				
AAKT-IG-R/L-2525-110-200-4-T28	●	○	25	25	150	26.5	28	110	200				
AAKT-IG-R/L-2525-110-200-4-T32	●	●	25	25	150	26.5	32	110	200				
AAKT-IG-R/L-2525-140-200-4-T25	○	○	25	25	150	26.5	25	140	200				
AAKT-IG-R/L-2525-180-800-4-T28	●	●	25	25	150	26.5	28	180	800				
AAKT-IG-R/L-2525-200-800-4-T25	○	○	25	25	150	26.5	25	200	800				
AAKT-IG-R/L-2525-70-110-5-T32	●	●	25	25	150	26.5	32	70	110	DGN / GRP - 5			
AAKT-IG-R/L-2525-110-200-5-T9	●	○	25	25	150	26.5	9	110	200				
AAKT-IG-R/L-2525-110-200-5-T32	●	●	25	25	150	26.5	32	110	200				
AAKT-IG-R/L-2525-180-800-5-T32	●	●	25	25	150	26.5	32	180	800	DGN / GRP - 6			
AAKT-IG-R/L-2525-58-100-6-T32	●	○	25	25	150	26.5	32	58	100				
AAKT-IG-R/L-2525-88-180-6-T32	●	○	25	25	150	26.5	32	88	180				

R: Sağ / Right / Правый L: Sol / Left / Левый  
● Stokta / In Stock / В наличии ○ Stokta Yok / Non Stock Item / Нет в наличии  
ISCR Uçuna Uygunudur. / Compatiple with ISCR Insert. / Под пластину ISCR.

Sipariş Örneği/Ordering Example/Образец заказа  
1 ad./pcs./шт. AAKT-IG-R-2525-40-60-4-T25



## L TİP ALIN KANAL AÇMA TAKIMLARI

### L TYPE FACE EXTERNAL GROOVING TOOLHOLDERS

#### ДЕРЖАВКИ L-ТИПА ДЛЯ ОБРАБОТКИ ТОРЦЕВЫХ КАНАВОК

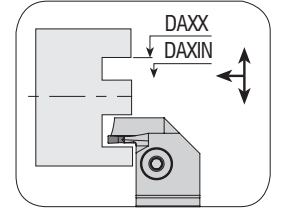
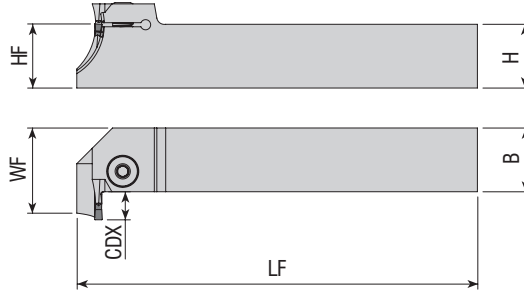

Takım Kodu Ordering Code Код для заказа	Stok Stock Наличие		Takım Ölçüleri (mm) Dimension (mm) Размеры (мм)							Kesici Uç Insert Пластина	Yedek Parçaları / Spare Parts / Запасные части		
	R	L	HF=H	B	LF	WF	CDX	DAXIN	DAXX		Sıkma Vidası Screw Зажимной винт	Pul Stamp Шайба	Anahtar Allen Key Ключ
ALKT-ZCC2-R/L-2525-35-45-3-T10	●	●	25	25	150	36	10	35	45	Z.FD - 3	2004-M8x1x20	-	AAL-05-4
ALKT-ZCC2-R/L-2525-39-55-3-T10	●	●	25	25	150	36	10	39	55				
ALKT-ZCC2-R/L-2525-35-∞-3-T4	●	●	25	25	150	30	4	35	∞				
ALKT-ZCC2-R/L-2525-40-60-4-T14	●	●	25	25	150	40	14	40	60	Z.GD - 4	2004-M8x1x20	-	AAL-05-4
ALKT-ZCC2-R/L-2525-52-80-4-T14	●	○	25	25	150	40	14	52	80				
ALKT-ZCC2-R/L-2525-72-110-4-T14	●	○	25	25	150	40	14	72	110				
ALKT-ZCC2-R/L-2525-100-230-4-T14	●	○	25	25	150	40	14	100	230				
ALKT-ZCC2-R/L-2525-40-∞-4-T4	●	●	25	25	150	30	4	40	∞				

ZCC Ucuna Uygundur. / Compatible with ZCC Insert. / Под пластину ZCC.

## KESME VE DERİN KANAL AÇMA LAMALARI

### BLADES FOR PARTING AND DEEP GROOVING

#### НОЖИ ДЛЯ ОТРЕЗКИ И ОБРАБОТКИ ГЛУБОКИХ КАНАВОК

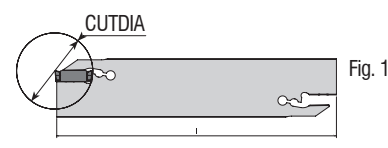
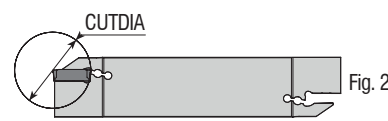
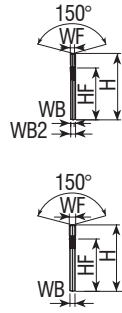
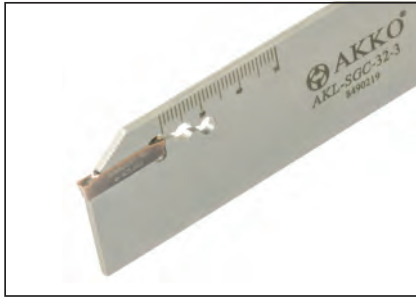

Takım Kodu Ordering Code Код для заказа	Stok Stock Наличие	Takım Ölçüleri (mm) Dimension (mm) Размеры (мм)								Kesici Uç Insert Пластина	Yedek Parçaları / Spare Parts / Запасные части
		H	WF	WB2	WB	I	HF	CUTDIA	Fig.		Anahtar Allen Key Ключ
AKL-SGC-26-3	●	26	3	2.40	-	110	21.4	39	2	GCM N30	ALA-02
AKL-SGC-32-3	●	32	3	2.40	-	150	25	39	1		

R: Sağ / Right / Правый L: Sol / Left / Левый

● Stokta / In Stock / В наличии ○ Stokta Yok / Non Stock Item / Нет в наличии

SMTM Ucuna Uygundur. / Compatible with SMTM Insert. / Под пластину SMTM.



Sipariş Örneği/Ordering Example/Образец заказа

1 ad./pcs./шт. ALKT-ZCC2-R-2525-35-45-3-T10



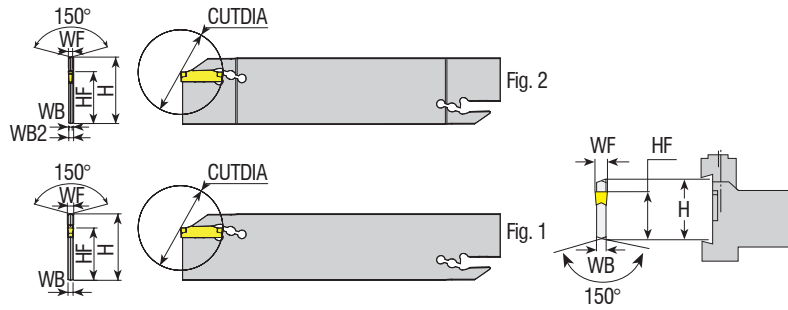

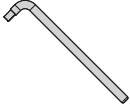

www.akko.com.tr

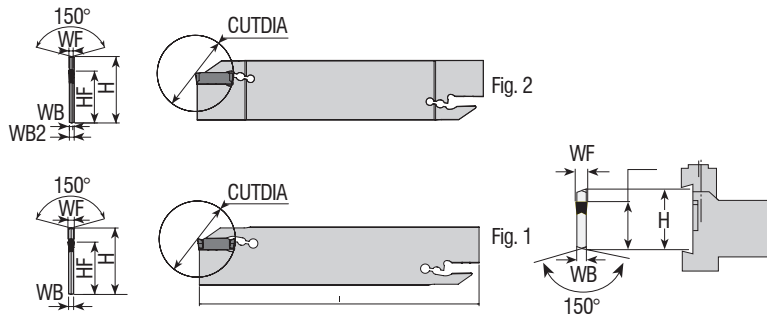

Takım Kodu Ordering Code Код для заказа	Stok Stock Наличие	Takım Ölçüleri (mm) Dimension (mm) Размеры (мм)								Kesici Uç Insert Пластина	Yedek Parçaları / Spare Parts Запасные части
		H	WF	WB2	WB	I	HF	CUTDIA	Fig.		
AKL-TD-32-2	●	32	2	2.4	1.6	150	25	39	2		
AKL-TD-32-3	●	32	3	2.4	-	150	25	39	1		

TGTC Ucuna Uygun. / Compatible with TGTC Insert. / Под пластину TGTC.

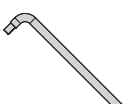

Takım Kodu Ordering Code Код для заказа	Stok Stock Наличие	Takım Ölçüleri (mm) Dimension (mm) Размеры (мм)								Kesici Uç Insert Пластина	Yedek Parçaları / Spare Parts Запасные части
		H	WF	WB2	WB	I	HF	CUTDIA	Fig.		
AKL-I-26-2	●	26	1.9-2.5	1.6	-	110	21.4	39	1		
AKL-I-32-2	●	32	1.9-2.5	1.8	2.4	150	25	39	2		
AKL-I-26-3	●	26	3-3.18	2.4	-	110	21.4	39	1		
AKL-I-32-3	●	32	3-3.18	2.4	-	150	25	39	1		
AKL-I-26-4	●	26	4	3.2	-	110	21.4	80	1		
AKL-I-32-4	●	32	4	3.2	-	150	25	100	1		

R: Sağ / Right / Правый L: Sol / Left / Левый  
● Stokta / In Stock / В наличии ○ Stokta Yok / Non Stock Item / Нет в наличии  
ISCR Ucuna Uygun. / Compatible with ISCR Insert. / Под пластину ISCR.

Sipariş Örneği/Ordering Example/Образец заказа  
1 ad./pcs./шт. AKL-TD-32-2

**KESME VE DERİN KANAL AÇMA LAMALARI**  
**BLADES FOR PARTING AND DEEP GROOVING**  
**НОЖИ ДЛЯ ОТРЕЗКИ И ОБРАБОТКИ ГЛУБОКИХ КАНАВОК**

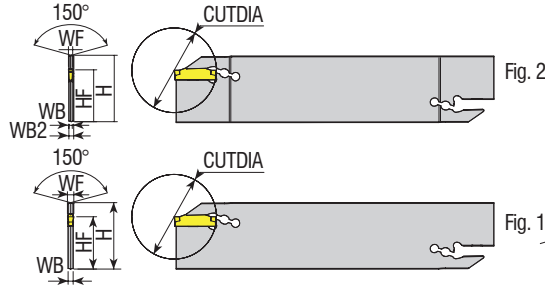

Takım Kodu Ordering Code Код для заказа	Stok Stock Наличие	Takım Ölçüleri (mm) Dimension (mm) Размеры (мм)								Kesici Uç Insert Пластина	Yedek Parçaları / Spare Parts Запасные части	
		H	WF	WB2	WB	I	HF	CUTDIA	Fig.		Anahtar Allen Key Ключ	
AKL-123-32-2	●	32	2	2.4	1.6	150	25	39	2		ALA-02	
AKL-123-32-3	●	32	3	2.4	-	150	25	39	1			
AKL-123-32-4	●	32	4	3.2	-	150	25	39	1			

SNDVK Ucuna Uygundur. / Compatible with SNDVK Insert. / Под пластину SNDVK.

**KESME VE DERİN KANAL AÇMA LAMA BLOĞU**  
**BLOCKS FOR PARTING AND DEEP GROOVING BLADES**  
**БЛОКИ К СМЕННЫМ НОЖАМ ДЛЯ ОТРЕЗКИ И ОБРАБОТКИ ГЛУБОКИХ КАНАВОК**

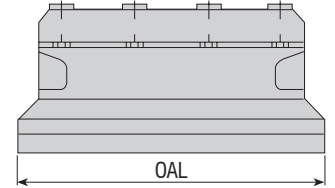
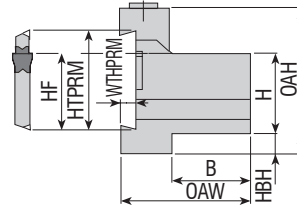

Takım Kodu Ordering Code Код для заказа	Stok Stock Наличие	Takım Ölçüleri (mm) Dimension (mm) Размеры (мм)									Yedek Parçaları / Spare Parts / Запасные части		
		HTPRM	HF	H	HBH	OAH	WTHPRM	OAL	B	OAW	Pabuç Clamp Spannspratze	Pabuç Vidası Clamp Screw Зажимной винт	Anahtar Allen Key Ключ
ALBU-20-26	●	26	21.4	20	9	43	4	86	19	38		2505-M6x25	AAL-07-5
ALBU-25-26	●	26	21.4	25	5	45	4	110	23	42			
ALBU-20-32	●	32	25	20	13	50	5.3	100	19	38			
ALBU-25-32	●	32	25	25	8	50	5.3	110	23	42			
ALBU-32-32	●	32	25	32	5	54	5.3	110	29	48			

R: Sağ / Right / Правый L: Sol / Left / Левый  
 ● Stokta / In Stock / В наличии ○ Stokta Yok / Non Stock Item / Нет в наличии

Sipariş Örneği/Ordering Example/Образец заказа  
 1 ad./pcs./шт. AKL-123-32-2

*konusulan  
the spoken kalite...  
quality...*



*konusulan  
the spoken kalite...  
quality...*

# KANAL AÇMA

İÇTEN SOĞUTMA KANALLI KANAL AÇMA TAKIMLARI  
GROOVING TOOLHOLDERS WITH COOLANT HOLE  
ДЕРЖАВКИ ДЛЯ ОБРАБОТКИ НАРУЖНЫХ КАНАВОК С ПОДВОДОМ СОЖ



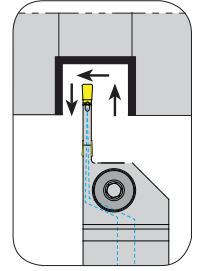
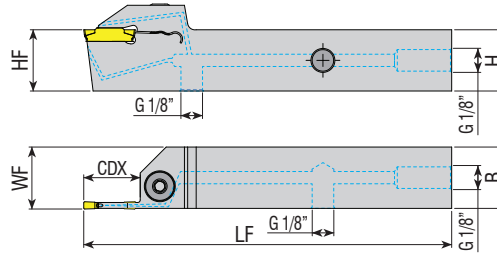

**Takım Kodu**  
**Ordering Code**  
Код для заказа

Takım Kodu Ordering Code Код для заказа	Stok Stock Наличие		Takım Ölçüleri (mm) Dimension (mm) Размеры (мм)					Kesici Uç Insert Пластина	Yedek Parçaları / Spare Parts / Запасные части		
	R	L	HF=H	B	LF	WF	CDX		Sıkma Vidası Screw Зажимной винт	Pul Stamp Шайба	Anahtar Allen Key Ключ
ADKT-K-R/L-2020-3-T20-H	●	●	20	20	125	20.4	20	MGM. - 3	2004-M8x1x20	-	AAL-05-4
ADKT-K-R/L-2525-3-T22-H	●	●	25	25	150	25.4	22				
ADKT-K-R/L-2020-4-T20-H	●	●	20	20	125	20.4	20	MGM. - 4			
ADKT-K-R/L-2525-4-T22-H	●	●	25	25	150	25.4	22				
ADKT-K-R/L-2525-5-T25-H	●	●	25	25	150	25.5	25	MGM. - 5			

KRLY Ucuna Uygun. / Compatible with KRLY Insert. / Под пластину KRLY.

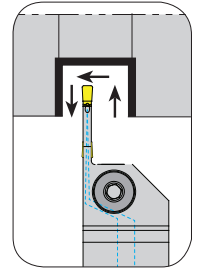
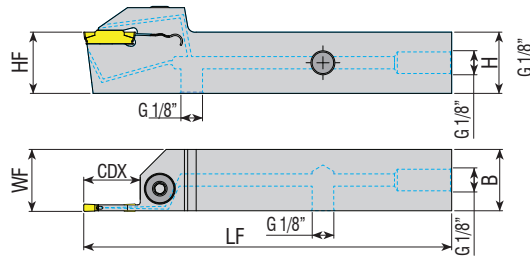
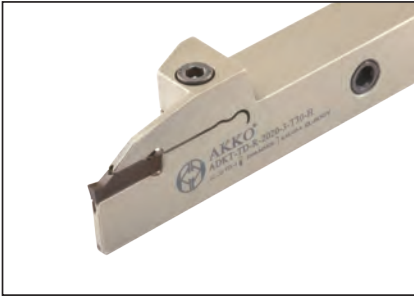

**Takım Kodu**  
**Ordering Code**  
Код для заказа

Takım Kodu Ordering Code Код для заказа	Stok Stock Наличие		Takım Ölçüleri (mm) Dimension (mm) Размеры (мм)					Kesici Uç Insert Пластина	Yedek Parçaları / Spare Parts / Запасные части		
	R	L	HF=H	B	LF	WF	CDX		Sıkma Vidası Screw Зажимной винт	Pul Stamp Шайба	Anahtar Allen Key Ключ
ADKT-TD-R/L-2020-3-T30-H	●	●	20	20	125	20.5	30	TD. - 3	2004-M8x1x20	-	AAL-05-4

R: Sağ / Right / Правый L: Sol / Left / Левый

● Stokta / In Stock / В наличии ○ Stokta Yok / Non Stock Item / Нет в наличии

TGTC Ucuna Uygun. / Compatible with TGTC Insert. / Под пластину TGTC.

Sipariş Örneği/Ordering Example/Образец заказа

1 ad./pcs./шт. ADKT-K-R-2020-3-T20-H



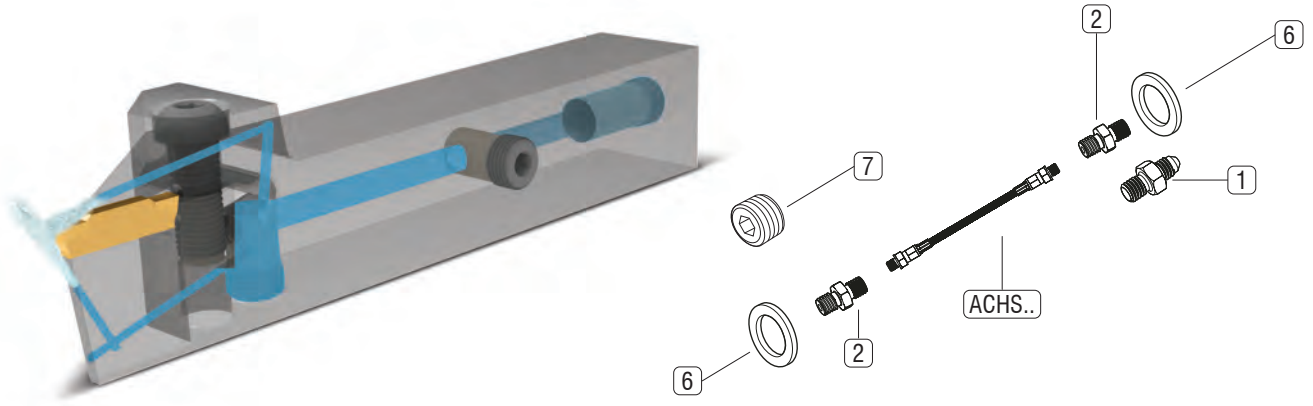

Not: İçten soğutmalı tüm torna katerlerinde kullanılabilecek 3 tip soğutma hortum setleri tasarlanmıştır. Takımların kullanılmasından önce, kullanılmayan bağlantıların set içindeki vida ile kapatılarak sızdırmazlığın sağlanmasına dikkat edilmelidir. Torna katerlerine yönelik soğutma hortum setleri, ACHS... 10 bar ile maksimum 275 bar basınç aralığında kullanılabilir.

Note: 3 types of cooling hose sets are designed that can be used in all internally cooled lathes. Before using the tools, care should be taken to ensure that the unused connections are closed with the screw in the set and that sealing is ensured. Cooling hose sets for lathe tools can be used in the pressure range of ACHS ... 10 bar to max 275 bar.

Примечание: Предлагается 3 типа комплектов трубок для подвода СОЖ. Они могут использоваться на всех токарных станках оснащенных системой подвода СОЖ. Перед началом работ необходимо закрыть неиспользуемые соединения винтом из набора и обеспечить герметичность системы подвода СОЖ. Комплекты охлаждающих трубок, для токарных инструментов, могут использоваться в диапазоне давлений АСНС .... от 10 бар до 275 бар.

Uzunluk / Length Code / Длина: 250

Set İçindeki Parçalar  
Parts In The Set  
Запчасти в Наборе

				Set Kodu: Set Code: Код Набора:	ACHS-1-250	Set Kodu: Set Code: Код Набора:	ACHS-2-250	Set Kodu: Set Code: Код Набора:	ACHS-3-250
1		AMP-01	M10 Bağlantı Elemanı M10 Fastener Застежка M10	1x	-	-	-	-	-
2		AMP-02	G 1/8" Çift Bağlantı Elemanı G 1/8" Double Fastener G 1/8" двойная застежка	2x	1x	-	-	-	-
3		AMP-03	G 1/8" Açılı Bağlantısı G 1/8" Angle Connection G 1/8" угловое соединение	-	1x	2x	-	-	-
4		AMP-04	M10" Açılı Bağlantısı M10" Angle Connection M10" угловое соединение	-	1x	1x	-	-	-
5		AMP-05	G1/4"-G1/8" Kılcalma Parçası G1/4"-G1/8" Capillary Piece G1/4"-G1/8" Капиллярная часть	-	1x	1x	-	-	-
6		AG-01	Bakır Conta Copper Gasket Медная прокладка	2x	3x	4x	-	-	-
7		2705-G1/8-5.5	G1/8" Sızdırmaz Civata G1/8" Sealing Bolt G1/8" Уплотнительный болт	1x	1x	1x	-	-	-
8		AH-1-250	Hortum Hose Трубка	1x	-	-	-	-	-
9		AH-2-250	Hortum Hose Трубка	-	1x	-	-	-	-
10		AH-3-250	Hortum Hose Трубка	-	-	1x	-	-	-

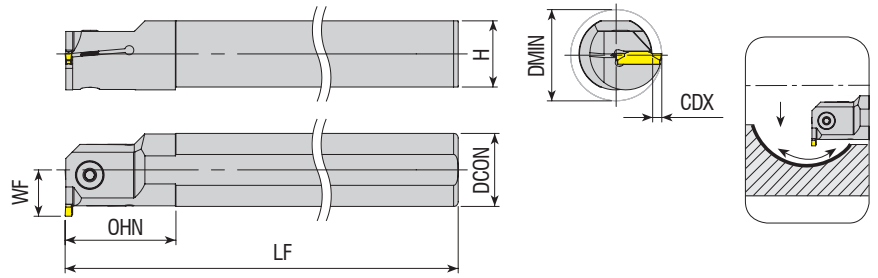

**Takım Kodu**  
**Ordering Code**  
Код для заказа

Stok  
Stock  
Наличие

Takım Ölçüleri (mm)  
Dimension (mm)  
Размеры (мм)

Kesici Uç  
Insert  
Пластина

Yedek Parçaları / Spare Parts / Запасные части

Sıkma Vidası  
Screw  
Зажимной винт

Anahtar  
Allen Key  
Ключ

Takım Kodu Ordering Code Код для заказа	Stok Stock Наличие		Takım Ölçüleri (mm) Dimension (mm) Размеры (мм)							Kesici Uç Insert Пластина	Sıkma Vidası Screw Зажимной винт	Anahtar Allen Key Ключ
	R	L	DCON	DMIN	LF	OHN	CDX	H	WF			
AIKT-K-R/L-16-2-T4	●	●	16	21	150	28	4	14.8	12	MGM. - 2	2503-M4x10	AAL-03-3
AIKT-K-R/L-20-2-T4	●	●	20	25	170	30	4	18.3	14		2503-M4x12	
AIKT-K-R/L-25-2-T6	●	●	25	32	200	40	6	23	18.5		2504-M5x12	
AIKT-K-R/L-20-3-T6	●	●	20	27	170	30	6	18.3	16	MGM. - 3	2504-M5x12	AAL-05-4
AIKT-K-R/L-20-3-T7	●	●	20	25	170	38	7	18.3	13		2504-M5x16	
AIKT-K-R/L-25-3-T6	●	●	25	32	200	40	6	23	18.5		2504-M5x16	
AIKT-K-R/L-25-3-T10	●	●	25	32	200	48	10	23	17		2004-M8x1x20	
AIKT-K-R/L-32-3-T6	●	●	32	39	250	50	6	30	22		2504-M5x12	
AIKT-K-R/L-32-3-T12	●	●	32	39	250	53	12	30	22		2504-M5x16	
AIKT-K-R/L-40-3-T6	●	●	40	47	300	55	6	37.5	26	MGM. - 4	2004-M8x1x20	AAL-05-4
AIKT-K-R/L-40-3-T12	●	○	40	48	300	63	12	37.5	27		2504-M5x12	
AIKT-K-R/L-20-4-T6	●	●	20	27	170	30	6	18.3	16		2504-M5x16	
AIKT-K-R/L-20-4-T7	●	○	20	25	170	38	7	18.3	13		2504-M5x16	
AIKT-K-R/L-25-4-T6	●	●	25	32	200	40	6	23	18.5		2004-M8x1x20	
AIKT-K-R/L-25-4-T10	●	●	25	32	200	49	10	23	17		2504-M5x12	
AIKT-K-R/L-32-4-T6	●	●	32	39	250	50	6	30	22	MGM. - 5	2504-M5x16	AAL-05-4
AIKT-K-R/L-32-4-T12	●	●	32	39	250	53	12	30	22		2004-M8x1x20	
AIKT-K-R/L-40-4-T6	●	●	40	47	300	55	6	37.5	26		2504-M5x16	
AIKT-K-R/L-40-4-T12	●	●	40	48	300	63	12	37.5	27	2004-M8x1x20		
AIKT-K-R/L-25-5-T7	●	●	25	33	200	40	7	23	19.5	MGM. - 5	2504-M5x16	AAL-05-4
AIKT-K-R/L-32-5-T7	●	●	32	40	250	50	7	30	23		2004-M8x1x20	
AIKT-K-R/L-40-5-T7	●	●	40	48	300	55	7	37.5	27		2504-M5x16	
AIKT-K-R/L-40-5-T12	●	○	40	48	300	63	12	37.5	27		2004-M8x1x20	

R: Sağ / Right / Правый L: Sol / Left / Левый  
● Stokta / In Stock / В наличии ○ Stokta Yok / Non Stock Item / Нет в наличии  
KRLY Ucuna Uygundur. / Compatiple with KRLY Insert. / Под пластину KRLY.

Sipariş Örneği/Ordering Example/Образец заказа  
1 ad./pcs./шт. AIKT-K-R-16-2-T4

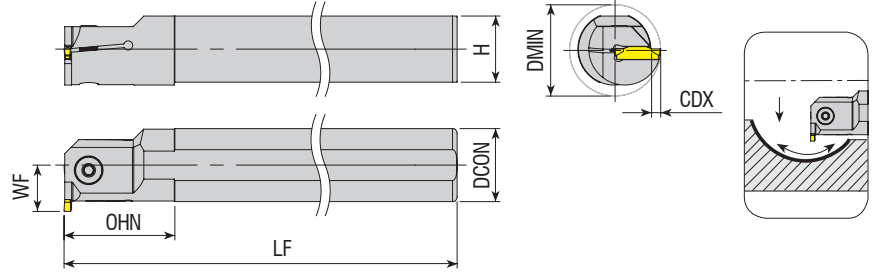

Takım Kodu Ordering Code Код для заказа	Stok Stock Наличие		Takım Ölçüleri (mm) Dimension (mm) Размеры (мм)							Kesici Uç Insert Пластина	Yedek Parçaları / Spare Parts / Запасные части	
	R	L	DCON	DMIN	LF	OHN	CDX	H	WF		Sıkma Vidası Screw Зажимной винт	Anahtar Allen Key Ключ
AIKT-KG-R/L-25-2-T7	●	●	25	33	200	40	7	23	19.5	KG.. - 2	2504-M5x12	AAL-05-4
AIKT-KG-R/L-20-3-T6.5-H	●	○	20	27.5	170	30	6.5	18.3	16.5		2504-M5x16	
AIKT-KG-R/L-25-3-T7	○	○	25	33	200	40	7	23	19.5	KG.. - 3	2004-M8x1x20	
AIKT-KG-R/L-40-3-T8	●	○	40	50	300	55	8	37.5	28		2504-M5x16	
AIKT-KG-R/L-25-4-T8	●	●	25	34	200	40	8	23	20.5	KG.. - 4		

KRLY Ucuna Uygun. / Compatible with KRLY Insert. / Под пластину KRYL

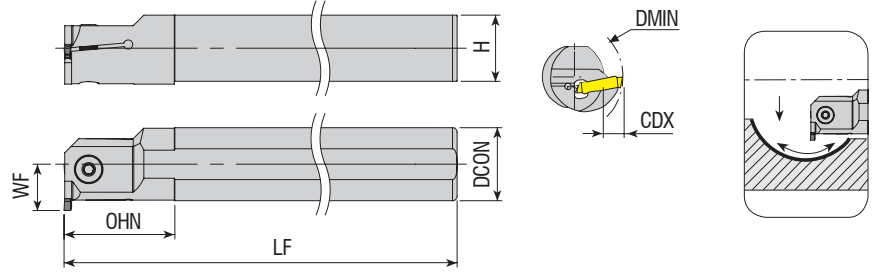

Takım Kodu Ordering Code Код для заказа	Stok Stock Наличие		Takım Ölçüleri (mm) Dimension (mm) Размеры (мм)							Kesici Uç Insert Пластина	Yedek Parçaları / Spare Parts / Запасные части	
	R	L	DCON	DMIN	LF	OHN	CDX	H	WF		Sıkma Vidası Screw Зажимной винт	Anahtar Allen Key Ключ
AIKT-H-R/L-25-3-T8	●	●	25	34	200	40	8	23	20.5	S229 - 3	2504-M5x16	AAL-05-4
AIKT-H-R/L-32-3-T7	●	●	32	40	250	50	7	30	23		2004-M8x1x20	
AIKT-H-R/L-40-3-T7	●	●	40	48	300	55	7	37.5	27	S229 - 4	2504-M5x16	
AIKT-H-R/L-25-4-T8	●	●	25	34	200	40	8	23	20.5		2004-M8x1x20	
AIKT-H-R/L-32-4-T7	●	●	32	40	250	50	7	30	23	S229 - 5	2504-M5x16	
AIKT-H-R/L-40-4-T7	●	●	40	48	300	55	7	37.5	27		2004-M8x1x20	
AIKT-H-R/L-25-5-T8	●	●	25	34	200	40	8	23	20.5			
AIKT-H-R/L-32-5-T7	●	○	32	40	250	50	7	30	23			
AIKT-H-R/L-40-5-T7	●	○	40	48	300	55	7	37.5	27			

R: Sağ / Right / Правый L: Sol / Left / Левый  
 ● Stokta / In Stock / В наличии ○ Stokta Yok / Non Stock Item / Нет в наличии  
 HRN Ucuna Uygun. / Compatible with HRN Insert. / Под пластину HRN

Sipariş Örneği/Ordering Example/Образец заказа  
 1 ad./pcs./шт. AIKT-KG-R-25-2-T7

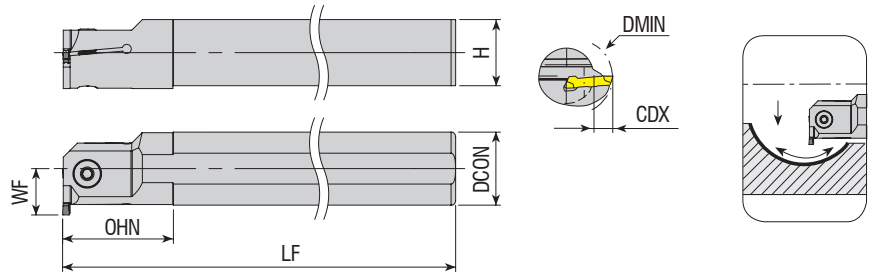

Takım Kodu Ordering Code Код для заказа	Stok Stock Наличие		Takım Ölçüleri (mm) Dimension (mm) Размеры (мм)							Kesici Uç Insert Пластина	Yedek Parçaları / Spare Parts / Запасные части	
	R	L	DCON	DMIN	LF	OHN	CDX	H	WF		Sıkma Vidası Screw Зажимной винт	Anahtar Allen Key Ключ
AIKT-HK-R/L-20-2-T6	●	●	20	26	170	30	6	18.3	16	S224 - 2	2503-M4x12	AAL-03-3
AIKT-HK-R/L-25-2-T6	●	○	25	32	200	40	6	23	18.5		2504-M5x16	
AIKT-HK-R/L-20-3-T6	●	○	20	27	170	30	6	18.3	16	S224 - 3	2504-M5x12	AAL-05-4
AIKT-HK-R/L-25-3-T6	●	●	25	32	200	40	6	23	18.5		2504-M5x16	
AIKT-HK-R/L-32-3-T6	●	●	32	39	250	50	6	30	22	S224 - 4	2004-M8x1x20	AAL-05-4
AIKT-HK-R/L-20-4-T6	●	○	20	27	170	30	6	18.3	16		2504-M5x12	
AIKT-HK-R/L-25-4-T6	●	○	25	32	200	40	6	23	18.5	2504-M5x16	2004-M8x1x20	AAL-05-4
AIKT-HK-R/L-32-4-T6	●	○	32	39	250	50	6	30	22	2504-M5x16		
AIKT-HS223-R/L-20-2-T5	●	○	20	26	170	33	5	18.3	15	S223 - 2	2503-M4x12	AAL-03-3
AIKT-HS223-R/L-25-2-T5	●	○	25	31	200	40	5	23	17.5		2504-M5x16	
AIKT-HS223-R/L-20-3-T6	●	○	20	27	170	33	6	18.3	16	S223 - 3	2504-M5x12	AAL-05-4
AIKT-HS223-R/L-25-3-T6	●	○	25	32	200	40	6	23	18.5		2504-M5x16	

HRN Ucuna Uygun. / Compatible with HRN Insert. / Под пластину HRN

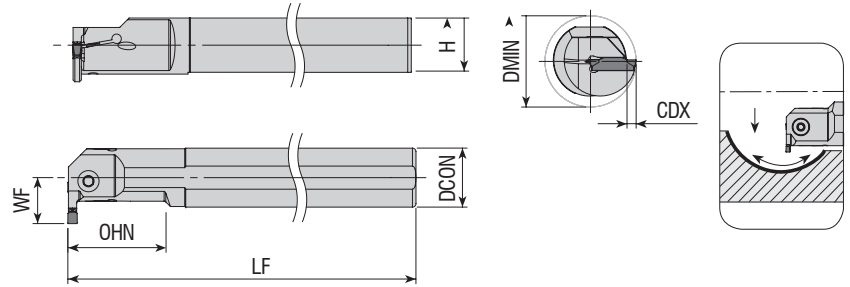

Takım Kodu Ordering Code Код для заказа	Stok Stock Наличие		Takım Ölçüleri (mm) Dimension (mm) Размеры (мм)							Kesici Uç Insert Пластина	Yedek Parçaları / Spare Parts / Запасные части	
	R	L	DCON	DMIN	LF	OHN	CDX	H	WF		Sıkma Vidası Screw Зажимной винт	Anahtar Allen Key Ключ
AIKT-KM-R/L-20-2-T7	●	●	20	25	170	40	7	18.3	13	A4 - 2	2503-M4x12	AAL-03-3
AIKT-KM-R/L-20-3-T7	●	○	20	25	170	40	7	18.3	13		2504-M5x12	AAL-05-4
AIKT-KM-R/L-25-3-T10	●	●	25	32	200	50	10	23	17	A4 - 3	2505-M6x16	AAL-07-5
AIKT-KM-R/L-32-3-T12	●	●	32	40	250	64	12	30	22		2505-M6x20	
AIKT-KM-R/L-40-3-T12	●	●	40	48	300	80	12	37.5	27	A4 - 4	2504-M5x12	AAL-05-4
AIKT-KM-R/L-20-4-T7	●	○	20	25	170	40	7	18.3	13		2504-M5x14	
AIKT-KM-R/L-32-4-T12.2-H	●	○	32	40	190	104	12.2	31	22			

R: Sağ / Right / Правый L: Sol / Left / Левый

● Stokta / In Stock / В наличии ○ Stokta Yok / Non Stock Item / Нет в наличии

KNMTL Ucuna Uygun. / Compatible with KNMTL Insert. / Под пластину KNMTL.

Sipariş Örneği/Ordering Example/Образец заказа

1 ad./pcs./шт. AIKT-HK-R-20-2-T6

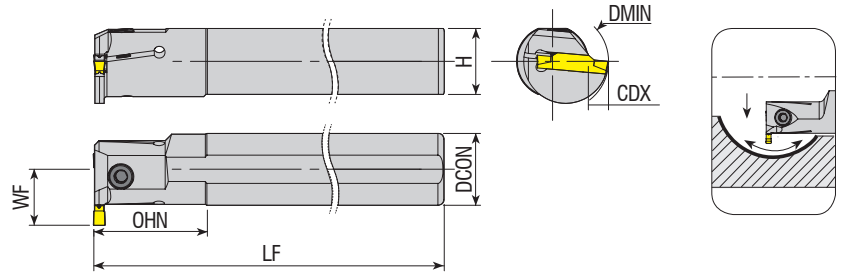

Takım Kodu Ordering Code Код для заказа	Stok Stock Наличие		Takım Ölçüleri (mm) Dimension (mm) Размеры (мм)							Kesici Uç Insert Пластина	Yedek Parçaları / Spare Parts / Запасные части		
	R	L	DCON	DMIN	LF	OHN	CDX	H	WF		Sıkma Vidası Screw Зажимной винт	Anahtar Allen Key Ключ	
AIKT-123-R/L-20-2-T6	●	○	20	32	170	30	6	18.3	16	123 - 2			AAL-03-3
AIKT-123-R/L-25-2-T6	●	○	25	32	200	40	6	18.3	18.5				
AIKT-123-R/L-32-2-T7	●	○	32	41	250	45	7	30	23				
AIKT-123-R/L-20-3-T6	●	○	20	32	170	30	6	18.3	16	123 - 3		AAL-05-4	
AIKT-123-R/L-25-3-T7	●	○	25	32	200	40	7	23	19.5				
AIKT-123-R/L-32-3-T9	●	○	32	41	250	50	9	30	25				
AIKT-123-R/L-20-4-T8	●	○	20	29	170	30	8	18.3	18	123 - 4		AAL-05-4	
AIKT-123-R/L-25-4-T7	●	○	25	32	200	40	7	23	19.5				
AIKT-123-R/L-32-4-T7	●	●	32	41	250	45	7	30	23				
AIKT-123-R/L-32-4-T10	●	○	32	43	250	50	10	30	26	123 - 5		AAL-05-4	
AIKT-123-R/L-25-5-T8	●	○	25	34	200	40	8	23	20.5				
AIKT-123-R/L-32-5-T11	●	●	32	43	250	50	11	30	27				

SNDVK Ucuna Uygundur. / Compatiple with SNDVK Insert. / Под пластину SNDVK.

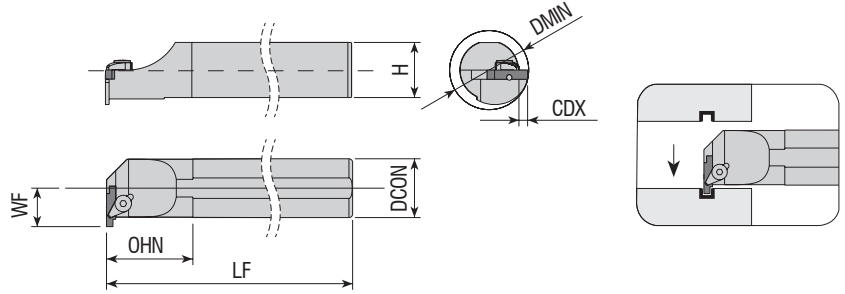

Takım Kodu Ordering Code Код для заказа	Stok Stock Наличие		Takım Ölçüleri (mm) Dimension (mm) Размеры (мм)							Kesici Uç Insert Пластина	Yedek Parçaları / Spare Parts / Запасные части				
	R	L	DCON	DMIN	LF	OHN	CDX	H	WF		Baskı Parçası Wedge Clamp Прижим	Sıkma Vidası Screw Зажимной винт	Pim Pin Stift	Anahtar Allen Key Ключ	
AIKT-154.91-R/L-16-3-T3	●	●	16	20	150	35	3	14.8	11	154.91 - 3				APM-06	AAL-05-4
AIKT-154.91-R/L-20-3-T4	●	●	20	25	170	38	4	18.3	14						
AIKT-154.91-R/L-25-3-T4	●	●	25	31	200	40	4	23	16.5						
AIKT-154.91-R/L-25-5-T5	●	●	25	31	200	45	5	23	17.5	154.91 - 5				AAL-03-3	
AIKT-154.91-R/L-32-5-T5	●	●	32	38	250	50	5	30	21						

R: Sağ / Right / Правый L: Sol / Left / Левый

● Stokta / In Stock / В наличии ○ Stokta Yok / Non Stock Item / Нет в наличии

SNDVK Ucuna Uygundur. / Compatiple with SNDVK Insert. / Под пластину SNDVK.

Sipariş Örneği/Ordering Example/Образец заказа

1 ad./pcs./шт. AIKT-123-R-20-2-T6

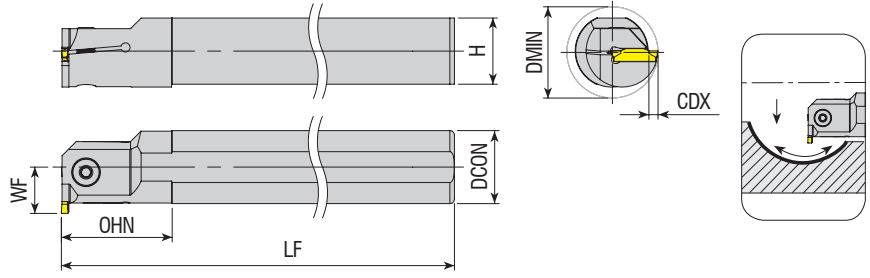

**Takım Kodu**  
**Ordering Code**  
**Код для заказа**

Takım Kodu Ordering Code Код для заказа	Stok Stock Наличие		Takım Ölçüleri (mm) Dimension (mm) Размеры (мм)							Kesici Uç Insert Пластина	Yedek Parçaları / Spare Parts / Запасные части	
	R	L	DCON	DMIN	LF	OHN	CDX	H	WF		Sikma Vidası Screw Зажимной винт	Anahtar Allen Key Ключ
AIKT-RD-R/L-16-2-T6	●	○	16	24	150	28	6	14.8	14	RD. - 2	2503-M4x10	AAL-03-3
AIKT-RD-R/L-20-2-T6	●	○	20	28	170	28	6	18.3	16			
AIKT-RD-R/L-25-2-T6	●	○	25	33	200	28	6	23	18.5			
AIKT-RD-R/L-16-3-T6	●	○	16	24	150	28	6	14.8	14	RD. - 3	2503-M4x10	AAL-05-4
AIKT-RD-R/L-20-3-T6	●	○	20	28	170	28	6	18.3	16			
AIKT-RD-R/L-25-3-T6	●	○	25	33	200	28	6	23	18.5			
AIKT-RD-R/L-32-3-T6	●	○	32	40	250	50	6	30	22	RD. - 4	2004-M8x1x20	
AIKT-RD-R/L-20-4-T6	●	○	20	28	170	28	6	18.3	16			
AIKT-RD-R/L-25-4-T6	●	○	25	33	200	28	6	23	18.5			
AIKT-RD-R/L-32-4-T6	●	○	32	40	250	50	6	30	22			

TGTC Ucuna Uygundur. / Compatiple with TGTC Insert. / Под пластину TGTC.

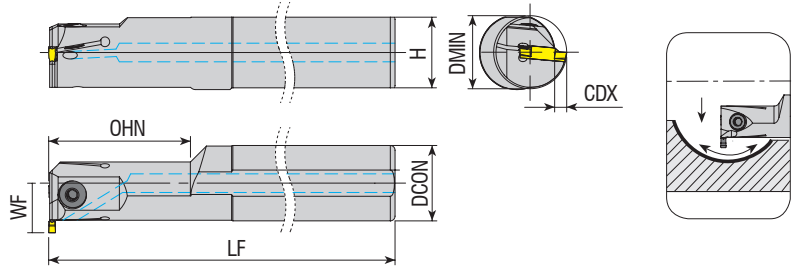

**Takım Kodu**  
**Ordering Code**  
**Код для заказа**

Takım Kodu Ordering Code Код для заказа	Stok Stock Наличие		Takım Ölçüleri (mm) Dimension (mm) Размеры (мм)							Kesici Uç Insert Пластина	Yedek Parçaları / Spare Parts / Запасные части	
	R	L	DCON	DMIN	LF	OHN	CDX	H	WF		Sikma Vidası Screw Зажимной винт	Anahtar Allen Key Ключ
AIKT-TD-R/L-16-2-T8.5-H	●	○	16	25	150	28	8.5	14.8	16.5	TD. - 2	2503-M4x10	AAL-03-3
AIKT-TD-R/L-20-3-T6-H	●	○	20	25	170	40	6	18.3	16	TD. - 3	2504-M5x12	AAL-05-4
AIKT-TD-R/L-25-3-T6-H	●	○	25	25	200	40	6	23	18.5		2504-M5x16	
AIKT-TD-R/L-32-3-T5-H	●	○	32	31	250	60	5	30	21		2004-M8x1x20	

R: Sağ / Right / Правый L: Sol / Left / Левый

● Stokta / In Stock / В наличии ○ Stokta Yok / Non Stock Item / Нет в наличии

TGTC Ucuna Uygundur. / Compatiple with TGTC Insert. / Под пластину TGTC.

Sipariş Örneği/Ordering Example/Образец заказа

1 ad./pcs./шт. AIKT-RD-R-16-2-T6

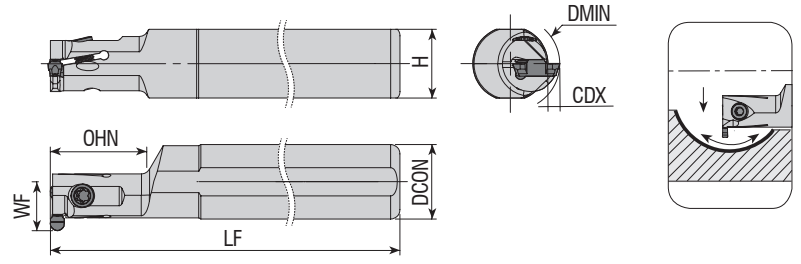

Takım Kodu Ordering Code Код для заказа	Stok Stock Наличие		Takım Ölçüleri (mm) Dimension (mm) Размеры (мм)							Kesici Uç Insert Пластина	Yedek Parçaları / Spare Parts / Запасные части	
	R	L	DCON	DMIN	LF	OHN	CDX	H	WF		Sıkma Vidası Screw Зажимной винт	Tork Anahtar Torx Key Торх Ключ
AIKT-IGE-R/L-10-2-T3-H	●	○	10	11.5	125	25	3	9	8.3	GEPI - 2	3008-M3x8	80-T08
AIKT-IGE-R/L-16-2-T3-D11.5	●	○	16	11.5	125	20	3	14.8	11.1		GEPI - 3	1315-M4x11
AIKT-IGE-R/L-16-2-T2.5-H	●	●	16	13	125	20	2.5	14.8	10.5			
AIKT-IGE-R/L-16-3-T2.5-H	●	○	16	13	125	20	2.5	14.8	10.5			
AIKT-IGE-R/L-16-3-T2.5-D20	●	○	16	20	125	28	2.5	14.8	10.5			

ISCR Uçuna Uygundur. / Compatible with ISCR Insert. / Под пластину ISCR.

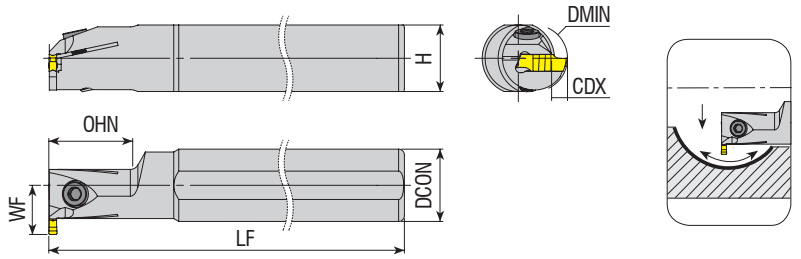

Takım Kodu Ordering Code Код для заказа	Stok Stock Наличие		Takım Ölçüleri (mm) Dimension (mm) Размеры (мм)							Kesici Uç Insert Пластина	Yedek Parçaları / Spare Parts / Запасные части		
	R	L	DCON	DMIN	LF	OHN	CDX	H	WF		Sıkma Vidası Screw Зажимной винт	Tork Anahtar Torx Key Торх Ключ	Anahtar Allen Key Ключ
AIKT-IGI-R/L-20-3-T4	●	●	20	20	170	25	4	18.3	14.5	GIMIY / GIPI - 3	1020-M5x14	80-T20	
AIKT-IGI-R/L-25-3-T5	●	●	25	23	200	30	5	23	17		2504-M5x16	AAL-05-4	
AIKT-IGI-R/L-32-3-T5	●	●	32	31	250	30	5	30	21		2004-M8x1x20		
AIKT-IGI-R/L-40-3-T5	●	○	40	50	300	50	5	37.5	25	GIMIY / GIPI - 4	1020-M5x14	80-T20	
AIKT-IGI-R/L-20-4-T4	●	●	20	20	170	25	4	18.3	14.5	GIMIY / GIPI - 5	2504-M5x16	AAL-05-4	
AIKT-IGI-R/L-25-5-T10	●	○	25	32	200	25	10	23	22.5				
AIKT-IGI-R/L-25-5-T15	●	○	25	37	200	25	15	23	27.5				

R: Sağ / Right / Правый L: Sol / Left / Левый  
● Stokta / In Stock / В наличии ○ Stokta Yok / Non Stock Item / Нет в наличии  
ISCR Uçuna Uygundur. / Compatible with ISCR Insert. / Под пластину ISCR.

Sipariş Örneği/Ordering Example/Образец заказа  
1 ad./pcs./шт. AIKT-IGE-R-10-2-T3-H

Note: "OHN" boyları D min çapa göre verilmiştir.  
Note: Lengths of "OHN" are given according to D min diameter.  
Примечание: размеры "OHN" должны быть D min.

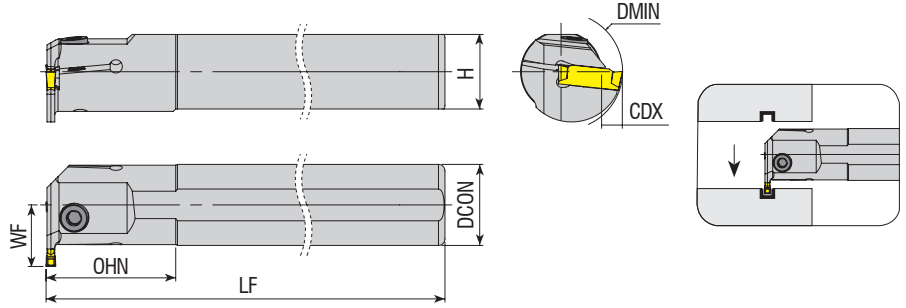

Takım Kodu Ordering Code Код для заказа	Stok Stock Наличие		Takım Ölçüleri (mm) Dimension (mm) Размеры (мм)							Kesici Uç Insert Пластина	Yedek Parçaları / Spare Parts / Запасные части	
	R	L	DCON	DMIN	LF	OHN	CDX	H	WF		Sıkma Vidası Screw Зажимной винт	Anahtar Allen Key Ключ
AIKT-I-R/L-20-3-T5	●	●	20	26	170	25	5	18.3	15.5	DGN - 3	2504-M5x12	AAL-05-4
AIKT-I-R/L-25-3-T6	●	●	25	32	200	40	6	23	19		2504-M5x16	

ISCR Ucuna Uygunur. / Compatiple with ISCR Insert. / Под пластину ISCR.

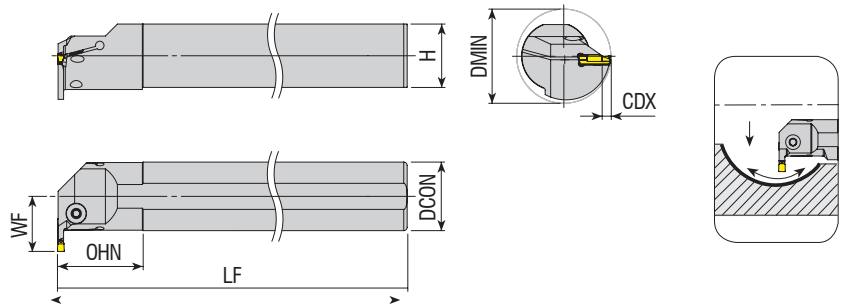

Takım Kodu Ordering Code Код для заказа	Stok Stock Наличие		Takım Ölçüleri (mm) Dimension (mm) Размеры (мм)							Kesici Uç Insert Пластина	Yedek Parçaları / Spare Parts / Запасные части	
	R	L	DCON	DMIN	LF	OHN	CDX	H	WF		Sıkma Vidası Screw Зажимной винт	Anahtar Allen Key Ключ
AIKT-IG-R/L-25-4-T10-H	●	●	25	36	200	40	10	23	22.7	DGN / GRP - 4	2504-M5X16	AAL-05-4
AIKT-IG-R/L-32-4-T10-H	●	●	32	43	250	45	10	30	26.2		2004-M8x1x20	
AIKT-IG-R/L-40-4-T12-H	●	●	40	53	250	50	12	37.5	32.2		2504-M5X16	
AIKT-IG-R/L-25-5-T10-H	●	○	25	36	200	40	10	23	22.7	DGN / GRP - 5	2004-M8x1x20	
AIKT-IG-R/L-32-5-T10-H	●	○	32	43	250	45	10	30	26.2		2504-M5X16	
AIKT-IG-R/L-40-5-T12-H	●	○	40	53	250	50	12	37.5	32.2		2004-M8x1x20	
AIKT-IG-R/L-50-5-T12-H	●	○	50	63	300	60	12	47	37.2			

R: Sağ / Right / Правый L: Sol / Left / Левый  
● Stokta / In Stock / В наличии ○ Stokta Yok / Non Stock Item / Нет в наличии  
ISCR Ucuna Uygunur. / Compatiple with ISCR Insert. / Под пластину ISCR.

Sipariş Örneği/Ordering Example/Образец заказа  
1 ad./pcs./шт. AIKT-I-R-20-3-T5



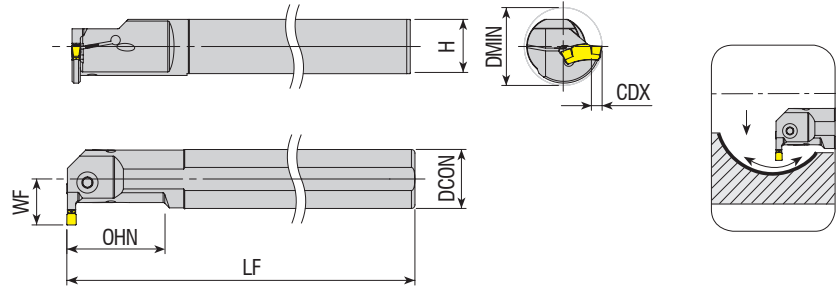

Takım Kodu Ordering Code Код для заказа	Stok Stock Наличие		Takım Ölçüleri (mm) Dimension (mm) Размеры (мм)							Kesici Uç Insert Пластина	Yedek Parçaları / Spare Parts / Запасные части		
	R	L	DCON	DMIN	LF	OHN	CDX	H	WF		Sıkma Vidası Screw Зажимной винт	Tork Anahtar Torx Key Торх Ключ	Anahtar Allen Key Ключ
AIKT-ITG-R/L-16-3-T6-H	●	●	16	20	150	25	6	14.8	12	TGM. - 3	1020-M4.5X14	80-T20	
AIKT-ITG-R/L-20-3-T6-H	●	●	20	25	170	32	6	18.3	14.2		1020-M4.5X16		
AIKT-ITG-R/L-25-3-T8-H	●	●	25	32	200	40	8	23	18.8		2504-M5X16	AAL-05-4	
AIKT-ITG-R/L-32-3-T8-H	●	●	32	38	250	49	8	30	22		2004-M8x1x20		
AIKT-ITG-R/L-20-4-T6-H	●	●	20	25	170	33	6	18.3	14.2	TGM. - 4	1020-M4.5X16	80-T20	
AIKT-ITG-R/L-25-4-T7-H	●	●	25	31	200	41	7	23	17.5		2504-M5X16	AAL-05-4	
AIKT-ITG-R/L-25-4-T9-H	●	●	25	32.5	200	41	9	23	19.5				
AIKT-ITG-R/L-32-4-T11-H	●	●	32	42	250	50	11	30	25.5				
AIKT-ITG-R/L-40-4-T11-H	●	●	40	53	300	50	11	37.5	32	2004-M8x1x20			
AIKT-ITG-R/L-32-6.35-T17.5-H	●	●	32	57	250	50	17.5	30	29	TGM. - 6.35			

ISCR Ucuna Uygunudur. / Compatible with ISCR Insert. / Под пластину ISCR.

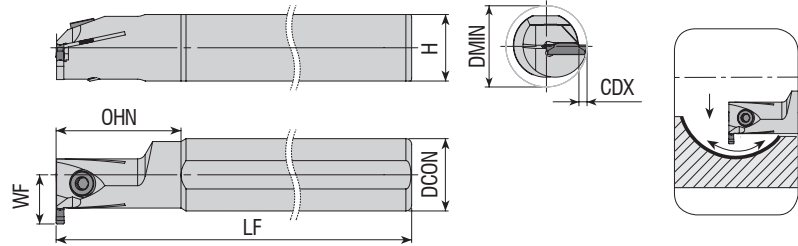

Takım Kodu Ordering Code Код для заказа	Stok Stock Наличие		Takım Ölçüleri (mm) Dimension (mm) Размеры (мм)							Kesici Uç Insert Пластина	Yedek Parçaları / Spare Parts / Запасные части	
	R	L	DCON	DMIN	LF	OHN	CDX	H	WF		Sıkma Vidası Screw Зажимной винт	Anahtar Allen Key Ключ
AIKT-GP-R/L-20-2-T4	●	○	20	25	170	30	4	18.3	14.5	GP - 2	2503-M4x12	AAL-03-3
AIKT-GP-R/L-25-2-T6	●	○	25	32	200	40	6	23	18.5			
AIKT-GP-R/L-20-3-T6	●	○	20	27	170	30	6	18.3	16	GP - 3	2504-M5X16	AAL-05-4
AIKT-GP-R/L-25-3-T6	●	○	25	32	200	40	6	23	18.5			
AIKT-GP-R/L-32-3-T6	●	○	32	39	250	50	6	30	22	2004-M8x1x20		
AIKT-GP-R/L-20-4-T6	●	○	20	27	170	30	6	18.3	16	GP - 4	2504-M5X16	AAL-05-4
AIKT-GP-R/L-25-4-T6	●	○	25	32	200	40	6	23	18.5		2004-M8x1x20	
AIKT-GP-R/L-32-4-T6	●	○	32	39	250	50	6	30	22			

R: Sağ / Right / Правый L: Sol / Left / Левый  
● Stokta / In Stock / В наличии ○ Stokta Yok / Non Stock Item / Нет в наличии  
PLBT Ucuna Uygunudur. / Compatible with PLBT Insert. / Под пластину PLBT.

Sipariş Örneği/Ordering Example/Образец заказа  
1 ad./pcs./шт. AIKT-ITG-R-16-3-T6-H

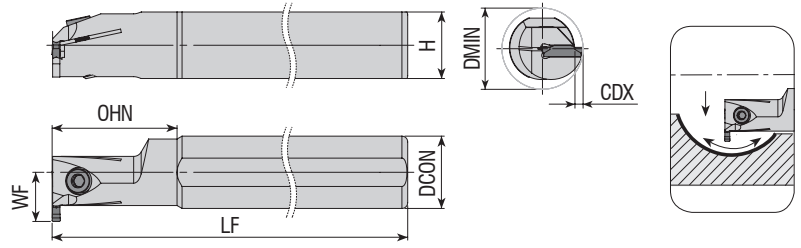

Takım Kodu Ordering Code Код для заказа	Stok Stock Наличие		Takım Ölçüleri (mm) Dimension (mm) Размеры (мм)							Kesici Uç Insert Пластина	Yedek Parçaları / Spare Parts / Запасные части		
	R	L	DCON	DMIN	LF	OHN	CDX	H	WF		Sıkma Vidası Screw Зажимной винт	Tork Anahtar Torx Key Торх Ключ	
AIKT-TG-R/L-20-2-T6	●	○	20	28	160	28	6	18.3	15.8	DGM2-020	2503-M4x10	AAL-03-3	
AIKT-TG-R/L-20-3-T6	●	○	20	28	160	28	6	18.3	15.8	DTX3-030	2504-M5x12	AAL-05-4	
AIKT-TG-R/L-25-3-T8	●	○	25	35	200	28	8	23	21.5		2504-M5x16		
AIKT-TG-R/L-32-3-T10	●	○	32	43	250	50	10	30	27	2004-M8x1x20			
AIKT-TG-R/L-32-3-T12	●	○	32	45	250	50	12	30	27				
AIKT-TG-R/L-32-4-T10	●	○	32	43	250	50	10	30	27		DTX4-040		
AIKT-TG-R/L-32-5-T10	●	○	32	43	250	50	10	30	27	DTX5-040			

TNGLY Ucuna Uygundur. / Compatible with TNGLY Insert. / Под пластины TNGLY.

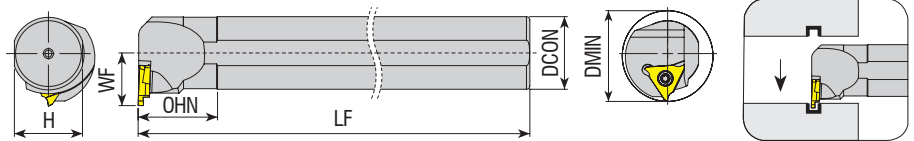

Takım Kodu Ordering Code Код для заказа	Stok Stock Наличие		Takım Ölçüleri (mm) Dimension (mm) Размеры (мм)							Kesici Uç Insert Пластина	Yedek Parçaları / Spare Parts / Запасные части	
	R	L	DCON	DMIN	LF	OHN	CDX	H	WF		Sıkma Vidası Screw Зажимной винт	Anahtar Allen Key Ключ
AIKT-QC11-R/L-20-(0.5-1.8)	●	○	20	16	150	40	-	18.3	12	QC11R/L (0.50-1.80)	3008 M2.5x6	80-T08
AIKT-QC16-R/L-20-(0.5-1.8)	○	○	20	25	150	35	-	18.3	13.5	QC16R/L (0.50-1.80)	4015-M3.5x10	80-T15
AIKT-QC16-R/L-20-(0.5-2.5)	●	○	20	25	150	35	-	18.3	13.5	QC16R/L (0.50-2.50)		
AIKT-QC22-R/L-25-(1-2.3)	○	○	25	35	150	35	-	23	18.2	QC22R/L (1.00-2.30)	1020 M5x11	80-T20
AIKT-QC22-R/L-25-(2.5-3.3)	●	○	25	35	150	35	-	23	18.2	QC22R/L (2.50-3.30)		
AIKT-QC22-R/L-25-(3.3-4.8)	●	○	25	35	150	35	-	23	18.2	QC22R/L (3.30-4.80)		
AIKT-QC22-R/L-32-(1-2.3)	○	○	32	45	150	35	-	30	23.2	QC22R/L (1.00-2.30)		

R: Sağ / Right / Правый L: Sol / Left / Левый

● Stokta / In Stock / В наличии ○ Stokta Yok / Non Stock Item / Нет в наличии

ZCC Ucuna Uygundur. / Compatible with ZCC Insert. / Под пластины ZCC.

Sipariş Örneği/Ordering Example/Образец заказа

1 ad./pcs./шт. AIKT-TG-R-20-2-T6

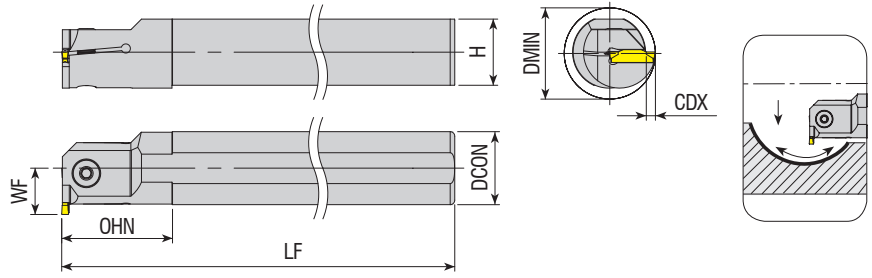

Takım Kodu Ordering Code Код для заказа	Stok Stock Наличие		Takım Ölçüleri (mm) Dimension (mm) Размеры (мм)							Kesici Uç Insert Пластина	Yedek Parçaları / Spare Parts / Запасные части								
	R	L	DCON	DMIN	LF	OHN	CDX	H	WF		Sıkma Vidası Screw Зажимной винт	Anahtar Allen Key Ключ							
AIKT-ZCC2-R/L-16-2-T4	●	○	16	21	150	28	4	14.8	12	Z.BD - 2	2503-M4x10	AAL-03-3							
AIKT-ZCC2-R/L-20-3-T5	●	●	20	27	170	30	5	18.3	15		Z.FD - 3		2504-M5x12	AAL-05-4					
AIKT-ZCC2-R/L-20-3-T8	●	○	20	29	170	30	8	18.3	18	Z.GD - 4		2504-M5x16							
AIKT-ZCC2-R/L-25-3-T5	●	○	25	31	200	40	5	23	17.5			Z.HD - 5	2004-M8x1x20						
AIKT-ZCC2-R/L-25-3-T10	●	○	25	36	200	40	10	23	22.5				2504-M5x12						
AIKT-ZCC2-R/L-32-3-T6	●	○	32	39	250	50	6	30	22						2004-M8x1x20				
AIKT-ZCC2-R/L-32-3-T8	●	○	32	41	250	50	8	30	24							2504-M5x16			
AIKT-ZCC2-R/L-32-3-T13	●	○	32	46	250	50	13	30	29								2504-M5x12		
AIKT-ZCC2-R/L-40-3-T12	●	○	40	53	300	55	12	37.5	32									2004-M8x1x20	
AIKT-ZCC2-R/L-25-4-T6	●	○	25	32	200	40	6	23	18.5										2504-M5x16
AIKT-ZCC2-R/L-32-4-T7	●	○	32	40	250	50	7	30	23										
AIKT-ZCC2-R/L-32-4-T8	●	○	32	41	250	50	8	30	24		Z.HD - 5								
AIKT-ZCC2-R/L-32-4-T10	●	○	32	43	250	50	10	30	26	2504-M5x12									
AIKT-ZCC2-R/L-32-5-T7	●	○	32	40	250	50	7	30	23			2004-M8x1x20							
AIKT-ZCC2-R/L-32-5-T8	●	○	32	41	250	50	8	30	24				2504-M5x16						
AIKT-ZCC2-R/L-40-5-T8	●	○	40	49	300	55	8	37.5	28					2004-M8x1x20					
AIKT-ZCC2-R/L-40-5-T10	●	○	40	51	300	55	10	37.5	30						2504-M5x12				

ZCC Ucuna Uygundur. / Compatible with ZCC Insert. / Под пластину ZCC.

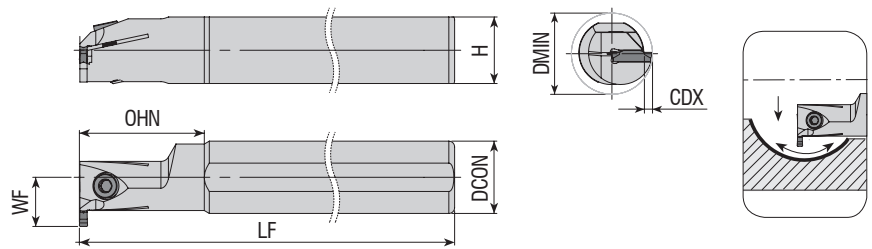

Takım Kodu Ordering Code Код для заказа	Stok Stock Наличие		Takım Ölçüleri (mm) Dimension (mm) Размеры (мм)							Kesici Uç Insert Пластина	Yedek Parçaları / Spare Parts / Запасные части	
	R	L	DCON	DMIN	LF	OHN	CDX	H	WF		Sıkma Vidası Screw Зажимной винт	Anahtar Allen Key Ключ
AIKT-SGC-R/L-25-3-T6	●	○	25	32	200	40	6	23	18.5	GCM N30	2504-M5x16	AAL-05-4
AIKT-SGC-R/L-32-3-T6	●	○	32	39	250	50	6	30	22		2004-M8x1x20	
AIKT-SGC-R/L-40-3-T6	●	○	40	47	300	55	6	37.5	26			

R: Sağ / Right / Правый L: Sol / Left / Левый  
● Stokta / In Stock / В наличии ○ Stokta Yok / Non Stock Item / Нет в наличии  
SMTM Ucuna Uygundur. / Compatible with SMTM Insert. / Под пластину SMTM

Sipariş Örneği/Ordering Example/Образец заказа  
1 ad./pcs./шт. AIKT-ZCC2-R-16-2-T4

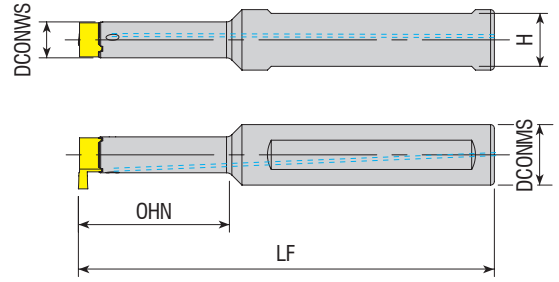

**Takım Kodu**  
**Ordering Code**  
Код для заказа

Takım Kodu Ordering Code Код для заказа	Stok Stock Наличие	Takım Ölçüleri (mm) Dimension (mm) Размеры (мм)					Kesici Uç Insert Пластина	Yedek Parçaları / Spare Parts / Запасные части		
		DCONMS	DCONWS	LF	OHN	H		Sıkma Vidası Screw Зажимной Винт	Anahtar Allen Key Ключ	
AIKT-MB07-A16-090-15	●	16	7.4	90	15	14	MB - 07	4008-M3x8	80-T08	
AIKT-MB07-A16-090-22	●	16	7.4	90	22	14				
AIKT-MB09-A16-090-19	●	16	9.5	90	19	14	MB - 09	4015-M4x11	80-T15	
AIKT-MB09-A16-095-28	●	16	9.5	95	28	14				
AIKT-MB09-A16-110-40	●	16	9.5	110	40	14				

R: Sağ / Right / Правый L: Sol / Left / Левый

● Stokta / In Stock / В наличии ○ Stokta Yok / Non Stock Item / Нет в наличии

SNDVK Ucuna Uygundur. / Compatible with SNDVK Insert. / Под пластину SNDVK.

Sipariş Örneği/Ordering Example/Образец заказа

1 ad./pcs./шт. AIKT-MB07-A16-090-15



**konusulan**  
the spoken **kalite...**  
quality...





**DELİK DELME ve İŞLEME TAKIMLARI**  
*DRILLING and HOLEMAKING TOOLS*  
*ИНСТРУМЕНТ ДЛЯ СВЕРЛЕНИЯ И ОБРАБОТКИ ОТВЕРСТИЙ*

